

Hydraulic Excavators

ACERA GEOSPEC

SK135SR

SK135SR_{LC}

- Bucket Capacity:
0.24 – 0.7 m³ ISO heaped
- Engine Power:
74 kW {100 PS}/2,000 min⁻¹{rpm}
(ISO14396)
- Operating Weight:
13,800 kg – SK135SR
13,900 kg – SK135SRLC

Complies with the latest exhaust emission regulations



US
EPA Tier III



EU (NRMM)
Stage IIIA



Latest Japanese
Regulations

That's KOBELCO!

Your First Choice

Powerful, Agile and Quiet.

New Performance Capabilities with a Small Rear Swing

The rounded form says it all: an excavator built with a tiny rear swing for maximum maneuverability. But KOBELCO has taken this concept one step further by seeing just how much digging performance can be packed into a machine. It's not the compact design that matters so much as the performance and functions that are actually used on site. And that's just where the new SR Series really shines, thanks to our NEXT-3E concept. So much so, in fact, that the SK135SR and other members of the series bear the same Acera Geospec name as our line of full-size excavators. Thanks to key iNDR technology, we've realized a whole new level of quiet operation, backed by a next-generation power plant that pushes performance to extraordinary new heights. Nine years after developing groundbreaking machines with tiny rear swings, KOBELCO continues to forge ahead as the leader in the field.





NEXT-3E



Pursuing the “Three E’s” The Perfection of Next-Generation, Network Performance

Enhancement

Greater Performance Capacity

- New hydraulic circuitry minimizes pressure loss
- High-efficiency, electronically controlled Common Rail Fuel Injection Engine
- Powerful travel and arm/bucket digging force

Economy

Improved Cost Efficiency

- Advanced power plant that reduces fuel consumption
- Easy maintenance that reduces upkeep costs
- High structural durability and reliability that retain machine value longer

Environment

Features That Go Easy on the Earth

- Newly developed iNDR technology reduces operational noise
- Meets the latest exhaust emissions standards
- Auto Idle Stop as standard equipment

ACERA
GEOSPEC ACERA GEOSPEC

The “GEO” in GEOSPEC expresses our deep respect for our planet, and for the solid ground where excavators are in their element. This is accompanied by SPEC, which refers to the performance specifications needed to get the job done efficiently as we carry on the tradition of the urban-friendly ACERA series.

iNDR

Integrated
Noise & Dust
Reduction
Cooling System

Amazingly Quiet!

Effective Dust Protection!

**Remarkable Ease of
Maintenance!**



Air intake

iNDR Filter

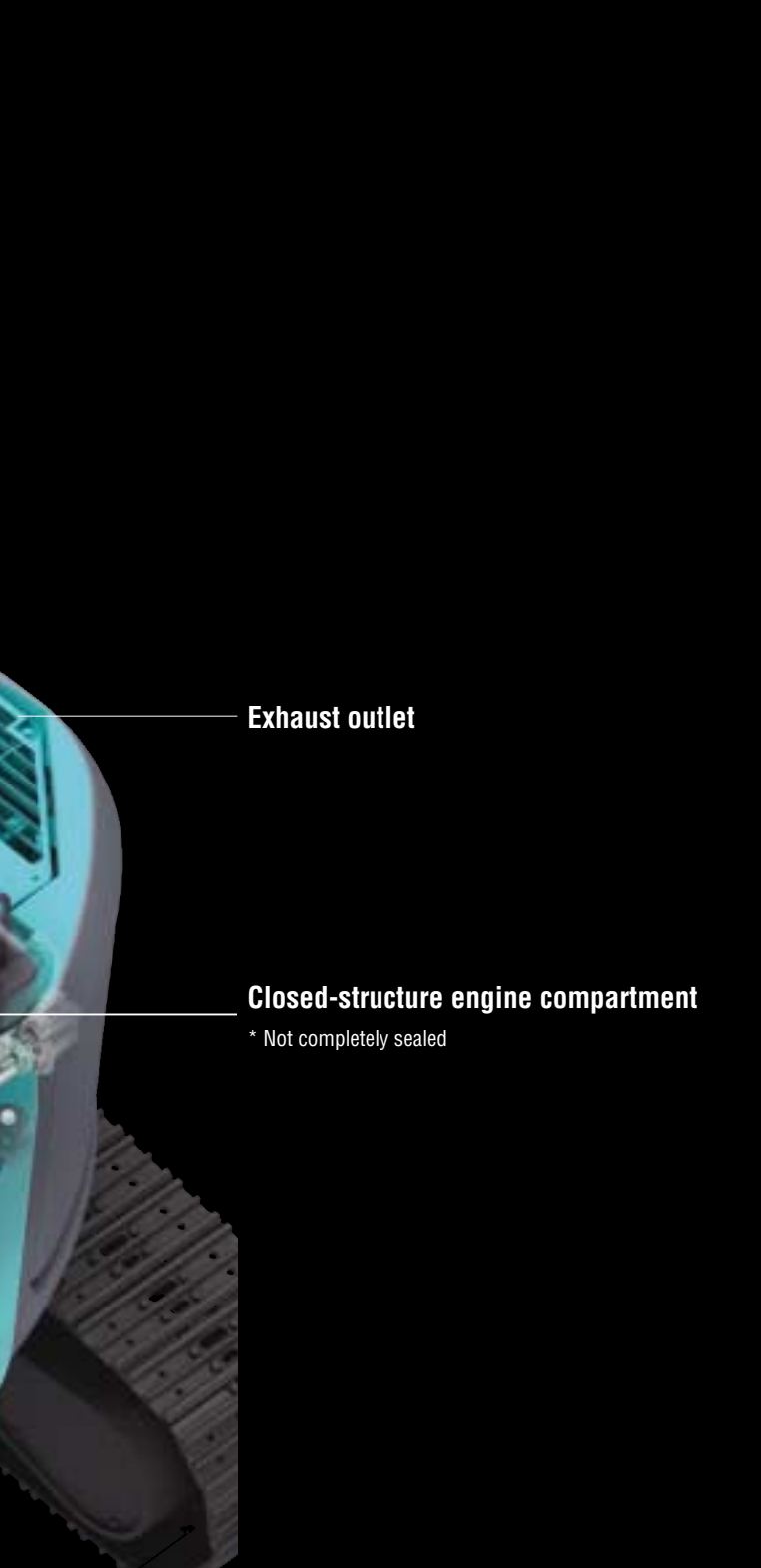

Exhaust outlet

Closed-structure engine compartment

* Not completely sealed

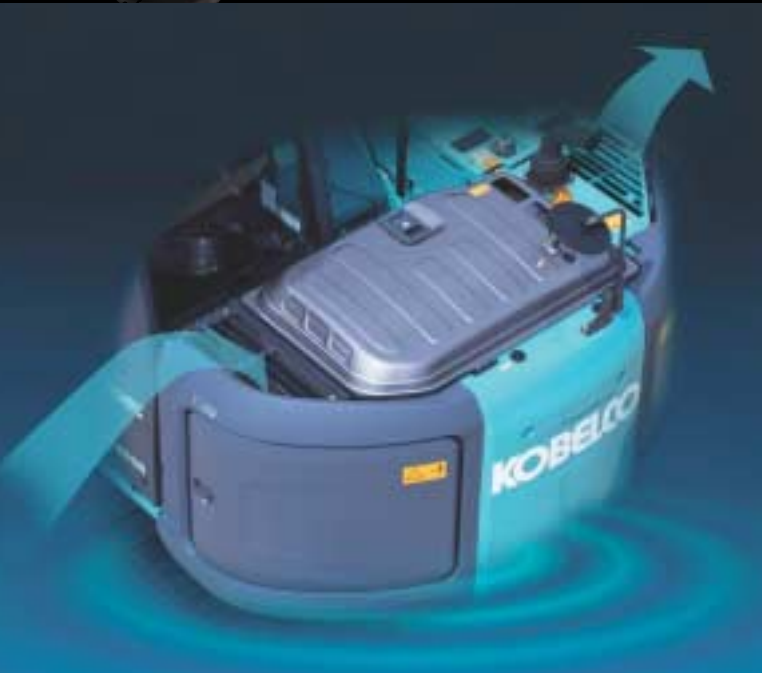

The iNDr Revolution

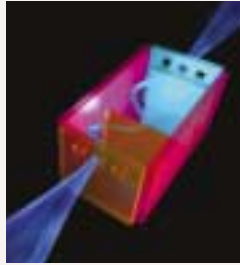

KOBELCO has developed the revolutionary Integrated Noise and Dust Reduction Cooling System, with the engine compartment placed inside a single duct that connects the air intake to the exhaust outlet.



The intake and exhaust are offset, with the holes and joints in the sections corresponding to the duct wall completely covered to reduce noise at the intake and exhaust apertures. This design, plus the generous use of insulation-material inside the duct, minimizes engine noise.



iNDr Filter

Also, iNDr filter in the intake aperture prevents dust from penetrating, which not only ensures a quieter, cleaner engine, but also supports the performance of the cooling unit and enhances ease of maintenance.

Far Surpassing Legal Requirements

The ACERA GEOSPEC SR series has broken through to a new frontier in quiet operation, with a noise level a full 5 dB below the Japanese government's requirements for ultra-low-noise machinery. In fact, compared with previous KOBELCO models, we have achieved a 10 dB reduction on the right-side surface of the machine, a difference that is clearly audible.



"Ultimate"-Low Noise Level of 93dB(A)

iNDr Filter Improves Operational Reliability



The stainless-steel filter is extremely effective against dust, with a 60-mesh wave-type screen that removes tiny dust particles from the intake air. This not only helps to keep the cooling unit and air cleaner running in top form, but also maintains ideal heat balance.

** "60-mesh" means that there are 60 holes formed by horizontal and vertical wires in every square inch of filter.*

Cooling Unit Requires No Regular Cleaning

Because the iNDr filter removes dust from the intake air, no dust gets into block the cooling components, so that no regular cleaning is necessary. The filter can be removed easily without tools and is installed in parallel with the intercooler, radiator, and oil cooler for easy access.



The GEOSPEC Difference:

More Work with Less Fuel !

Fuel Consumption and Work Volume

Amazing productivity with a max. 8% decrease in fuel consumption per hour and a max. 15% increase in work volume per liter of fuel.

Fuel Consumption and Work Volume (New S-mode)

| | Vs Previous SK135SR in H-mode | Vs Previous SK135SR in S-mode |
|---|---|--|
| Fuel Consumption (L/h) |  8% decrease | Almost the same |
| Work volume per liter of fuel (m ³ /L) |  15% increase |  4% increase |

“Top-Class” Powerful Digging

Max. arm crowding force: **64.4 kN {6.57 tf}**

Max. bucket digging force: **90.1 kN {9.19 tf}**

Powerful Travel

Travel torque: increased by **9 %** 

Drawbar pulling force: **139 kN {14.2 tf}**



Next-generation electronic engine control

Photo: SK135SR with Japanese spec.

* The value shows results from actual measurements taken by KOBELCO continuous operation in S Mode, compared with previous model, SK135SR-IES. Results will vary depending on operating method and load conditions.



Greater Swing Power, Shorter Cycle Times

Swing torque: increased by **5.0 %** ↑
 Swing torque: **39.9 kN**
 Swing Speed: **11.5 min⁻¹**

Significant Extension of Continuous Working Hours

The combination of a large-capacity fuel tank and excellent fuel efficiency delivers an impressive max. 19% increase in continuous operation hours.*
 **Fuel tank: 200 L**

Light Lever Operation

Lighter levers mean less operator fatigue over long hours of operation.

10 % Less

Dramatic Increase in Maximum Dumping Height

Max. digging height:
9,190 mm
 (560 mm more than previous model)

Max. dumping height:
6,740 mm
 (540 mm more than previous model)

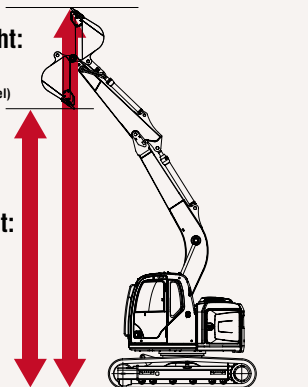

The bottom of the upper frame features single-plate construction for solid stability, combined with dramatic increases in maximum digging and dumping heights to deliver a wider working range than ever before.

*Previous model: SK135SR-IES.

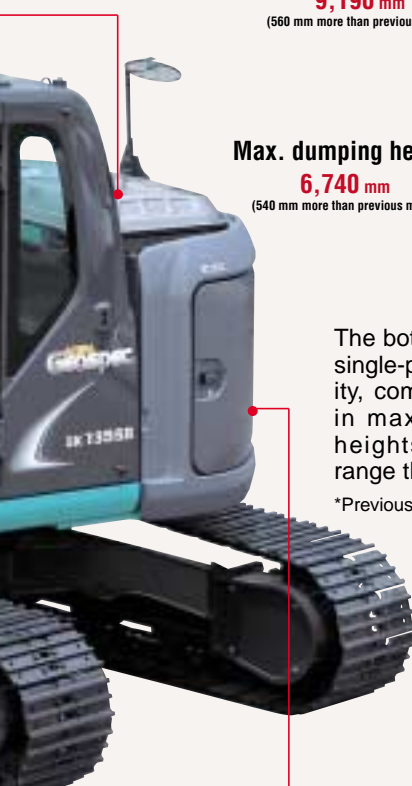

New, high-efficiency pump

1 NEXT-3E Technology New Hydraulic System

Rigorous inspections for pressure loss are performed on all components of the hydraulic piping, from the spool of control valve to the connectors. This regimen, combined with the use of a new, high-efficiency pump, cuts energy loss to a minimum.

2 NEXT-3E Technology Next-Generation Electronic Engine Control



The high-pressure, common-rail fuel-injection engine with the multiple injection system features adjustable control to maximize fuel efficiency and provide powerful low-speed torque. The result is a highly fuel-efficient engine.

3 NEXT-3E Technology Total Tuning Through Advanced ITCS Control

The next-generation engine control is governed by a new version of ITCS, which responds quickly to sudden changes in hydraulic load to ensure that the engine runs as efficiently as possible with a minimum of wasted output.

ITCS ITCS (Intelligent Total Control System) is an advanced, computerized system that provides comprehensive control of all machine functions.

Simple Select: Two Digging Modes

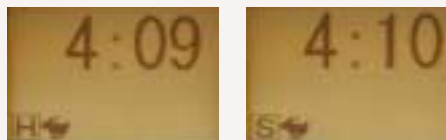

- H** For heavy duty when a higher performance level is required.
H-Mode
- S** For normal operations with lower fuel consumption.
S-Mode

Optional N&B (crusher and breaker)

The operator selects the desired mode from inside the cab, and the selector valve automatically configures the machine accordingly.

Attachment Mode Selector Switch

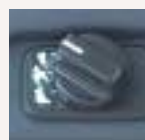

There's a choice of three different hydraulic circuits, to accommodate bucket, crusher or breaker, and the desired attachment mode can be selected with a switch, which automatically configures the selector valve. All attachment modes can be used in either S-mode or H-mode.

Seamless, Smooth Combined Operations

The GEOSPEC machines have inherited the various systems that make inching and combined operations easy and accurate, with further refinements that make a good thing even better. Leveling and other combined operations can be carried out gracefully.

- Electronic active control system
- Arm regeneration system
- Boom lowering regeneration system
- Variable swing priority system
- Swing rebound prevention system

The GEOSPEC Difference:

Rugged Durability That Ensures Long-Term Machine Value!

Durability That Retains Machine Value Five and Ten Years in the Future

- Improved heat resistance in the swing motor, cylinders and other hydraulic components
- New operator's seat covered by durable material

Double-Element Air Cleaner

The air cleaner that comes standard on the SK135SR has a large capacity and twice the durability of previous cleaners. Also, because it's installed behind the iNDR filter, it offers more reliable and efficient cleaning performance.



High-Grade Fuel Filter

The SK135SR features a high-performance filter designed specifically for common-rail engine that has 2.9 times more filtering area than previous filters.

Highly Reliable ITCS

The manufactured quality of the ITCS controller has been further upgraded, with special measures taken to protect against water and dust. Improvements have also been made in the specs of the pressure sensors, as well as anti-noise performance.



Easily repaired bolted handrails

High-quality urethane paint

Reinforced Crawler Shoes

The diameter of the track link pins has been made a size larger for even greater strength.



Photo: SK135SR with Japanese spec.



**The GEOSPEC Difference:
Designed to Operate Effectively
in Close Quarters!**

Watch the Job in Front, Not the Counterbalance

The tail of the upper body extends very little past the back end of the crawlers so that the operator can concentrate on the job at hand instead of worrying about the position of the counterweight. This not only improves operating efficiency but reduces costs associated with collision damage.

Requires Less Than 3.5 m of Working Space

The compact design allows the machine to perform continuous 180° dig, swing and load operations within a working space of just 3.5 m.

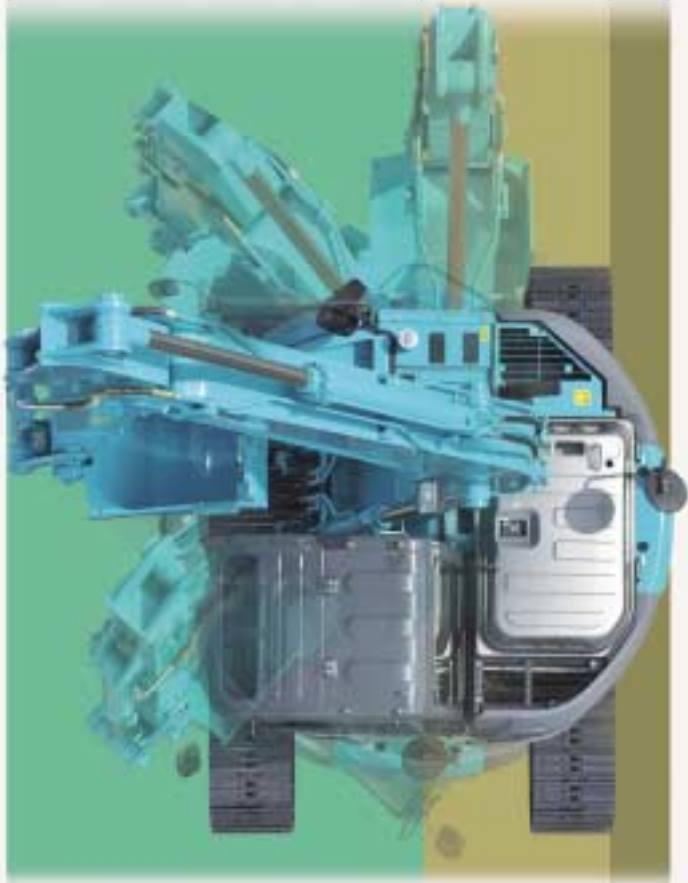
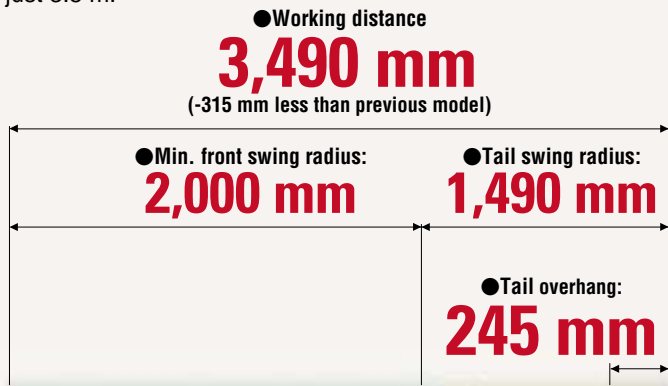

Working distance equals the sum of the minimum forward swing radius and tail swing radius.



**The GEOSPEC Difference:
Designed for the Environment
and the Future!**

**Meets Standard Values Set by Emissions
Regulations**

The engine used in the GEOSPEC machines represents the crystallization of various cutting-edge technologies that minimize the emission of PM (Particulate Matter), NOx, black smoke, and other emissions, thus meeting all internationally recognized environmental regulations, including US EPA Tier III, NRMM (Europe) Stage IIIA, and Act on Regulation, Etc. of Emission from Non-road Special Motor Vehicles (Japan).

**Auto Idle Stop Provided as Standard
Equipment**

This function saves fuel and cuts emissions by shutting down the engine automatically when the machine is on stand by. It also stops the hourmeter, which helps to retain the machine's asset value.

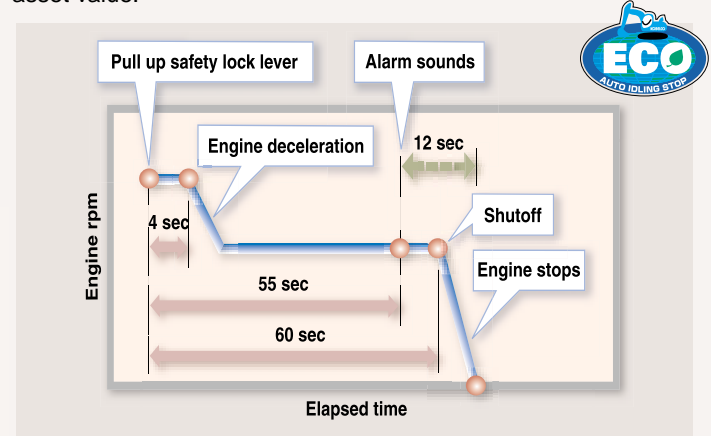

**Automatic Acceleration/Deceleration Function
Reduces Engine Speed**

Engine speed is automatically reduced when the control lever is placed in neutral, effectively saving fuel and reducing noise and exhaust emissions. The engine quickly returns to full speed when the lever is moved out of neutral.

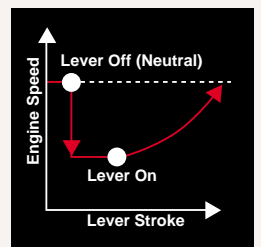

Mild Operating Sound

The iNDR cooling system also helps to keep the machine quiet, even at close quarters. Even the hydraulic relief valves have been designed specifically to reduce irritating noise during operation.

**Meets EMC (Electromagnetic Compatibility)
Standards in Europe.**

Electrical shielding ensures that the machines clear all European standards and neither cause or are affected by electromagnetic interference.

The GEOSPEC Difference:

Fast, Accurate and Low-Cost Maintenance!

Comfortable “On the Ground” Maintenance

All of the components that require regular maintenance are laid out for easy access, with the control valves located on a single right-hand panel that opens and closes at a touch. Behind that, in the pump compartment, there is remote access to such components as the engine oil filter and fuel filter (with built-in water separator). On the left side are the iNDr filter, air cleaner, radiator coolant, etc. Daily maintenance can be carried out easily without the need to climb onto the machine.

Left side



Radiator reservoir tank

- Easy access to cooling units

Right side



Hydraulic pump

- Easy access to pump

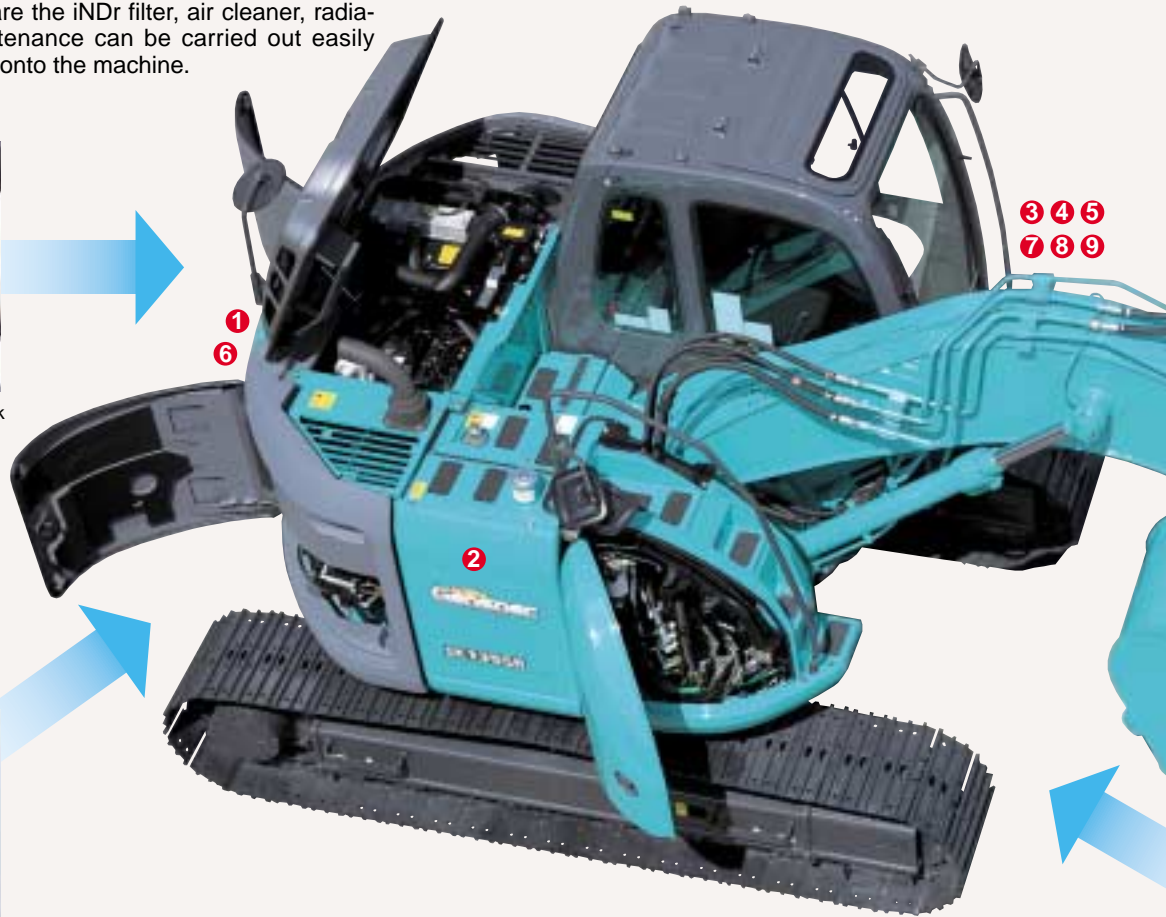
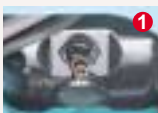

Photo: SK135SR with Japanese spec.

Fast Maintenance



- Engine quick-drain cock can be turned without tools.



- Fuel tank equipped with bottom flange and large drain cock.



- Hour meter can be checked while standing on the ground.



- Easy-access fuse box. More finely differentiated fuses make it easier to locate malfunctions.



- Washer fluid tank located under the cab floor mat.



- Easily replaceable engine oil filter

- Starter easily replaced from the pump side

iNDr Means Easy Maintenance

iNDr Filter Blocks Out Dust



Outside air goes directly from the intake duct through the iNDr filter for dust removal. The filter features a 60-mesh screen, which means it has sixty holes per inch both vertically and horizontally, with a wide front surface area and accordion structure that resists clogging.



Visual Checking and Easy Cleaning



When checking and cleaning the cooling system, one must deal with several different components like the radiator, oil cooler and intercooler, which all must be handled in different ways. But with the iNDr filter, there's just one filter in one place. If it looks dirty during start-up inspection, it can be cleaned easily and quickly.

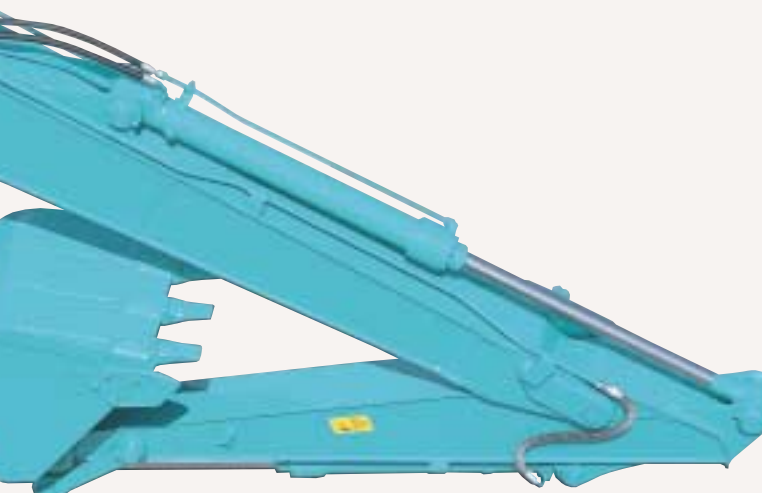

- Easy access to main control valves

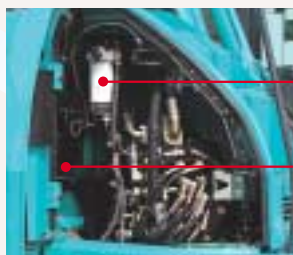

Fuel filter with water separator



Tool box

Easy Cleaning

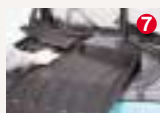

- Detachable two-piece floor mat with handles for easy removal. A floor drain located under floor mat



- Internal and external air conditioner filters can be easily removed without tools for cleaning



- Special crawler frame designed is easily cleaned of mud

Long-Interval Maintenance



- Long-life hydraulic oil reduces cost and labor.

Super-fine Filter

- High-performance, super-fine filter has a 1,000-hour replacement cycle.



● Super-fine filter

Double-Element Air Cleaner

The high-performance air cleaner has twice the capacity and service life of previous air cleaners and is installed behind the iNDr filter for even more effective cleaning performance.

High-Grade Fuel Filter with Superior Filtration Performance

The high-performance, large capacity filter is specially designed for a common-rail engine and features 2.9 times more filtering area than previous filters.

Monitor Display with Essential Information for Accurate Maintenance Checks



- Displays only the maintenance information that's needed, when it's needed.
- Self-diagnostic function that provides early-warning detection and display of electrical system malfunctions.
- Record function of previous breakdowns including irregular and transient malfunction.

Choice of 16 languages for Monitor Display

With messages including those requiring urgent action displayed in the local language, users in all parts of the world can work with greater peace of mind.

The GEOSPEC Difference:

A Working Environment That Helps the Operator Concentrate

Newly-designed 'Big Cab'



The new 'Big Cab' has the same width and height as the cabs installed on much larger machines. With more space to the front of the operator, it feels more roomy, and the larger area of floor space means greater comfort from the feet up. The operator has plenty of space in front for easy, comfortable operation, with ample foot room.

- 45mm wider than previous models for a total width of 1,000 mm
- 32% more front-to-back foot room (an additional 180mm) than previous models
- Separate N&B pedal and footrest, with a larger travel pedal

Excellent Visibility

The wide, open view in front combines with minimized blind spots around the machine for greater onsite safety.



- Front window area is 8% larger than previous models
- Reinforced green glass meets European standards
- New "rise-up" wipers keep the view clear and clean
- Broad wiper area improves visibility in bad weather

Wide-Access Cab Ensures Smooth Entry and Exit



The cab door is 40 mm wider than the previous models, and the control box together with the safety lock lever tilts up by a larger angle, for easy cab entry and exit.

In-Cab Noise is Reduced by 5 dB

Compared with Previous Models

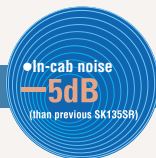

Always Easy to Read! New Information Display



Large analog gauges with large numbers and letters and glare-reducing visors are always easy to read regardless of working conditions.

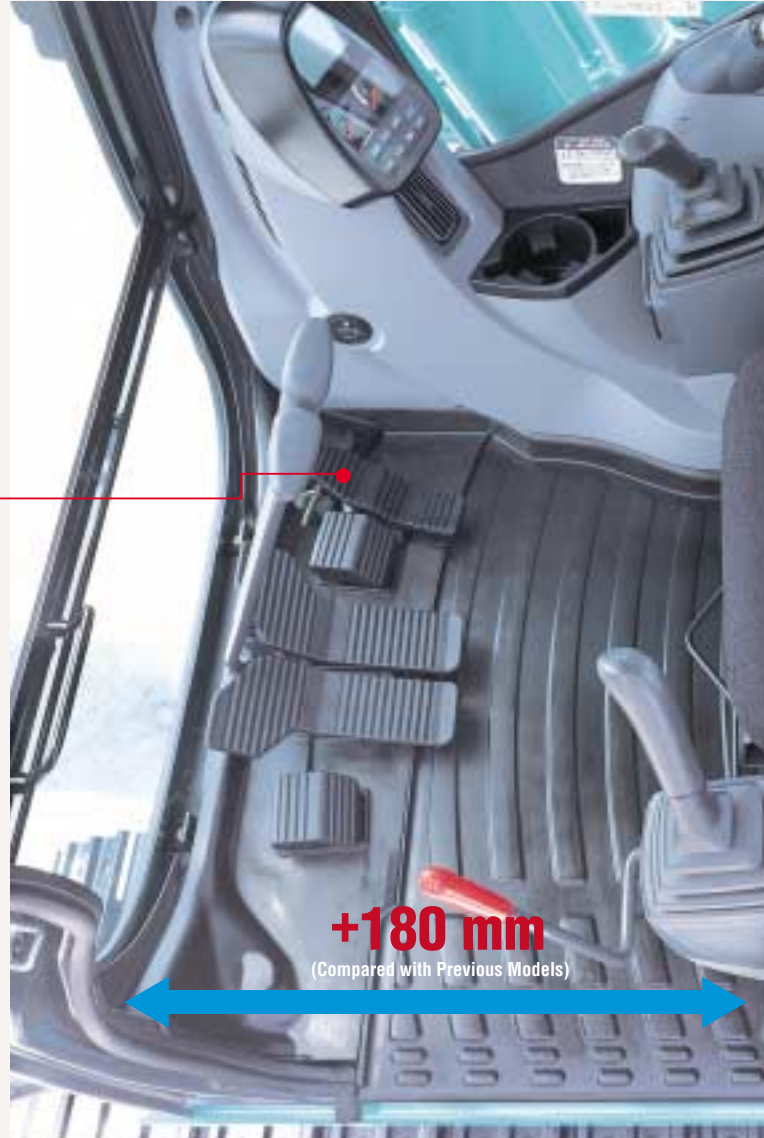

Comfortable Operating Environment



- New reclining seat can be lowered well down to the back.

on the Job at Hand!



The photo includes optional pedals for N & B. Suspension seat not shown.

Cab Brackets



The ACERA GEOSPEC SR series has a safety rating equivalent to FOPS level 1. In addition to the standard roof guard, optional front and head guards are available. They can be easily attached with bolts to the standard cab brackets.

Cab Interference Prevention System (For side digging applications, with standard 0.5 m³ bucket only)

- Attachment Position Indicator
Data on attachment position detected by sensors is analyzed and displayed in the monitor.
- Depth Limit
As the bucket approaches a preset depth, operation stops automatically. Work can be completed smoothly and safely even when close to the location of utility pipes.
- Height Limit
As the attachment approaches a preset height, operation stops automatically. Jobs in built-up areas with overhead electricity and telephone wires can be completed smoothly and safely.
- Left Offset Limit
As the bucket approaches the preset offset distance, operation stops automatically. This function is very convenient for offset jobs, ensuring precise positioning of the bucket every time.



● Attachment angle sensor



● Monitor display

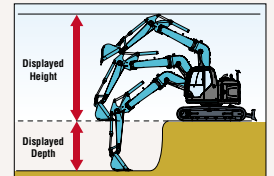

Better Visibility Than Ever Before

The wide, open view in front combines with minimized blind spots around the machine for greater onsite safety, with two handrail mirrors, a cab mirror, and a rear mirror on the counterweight providing better visibility than ever before.

● Cab mirror



● Two handrail mirrors

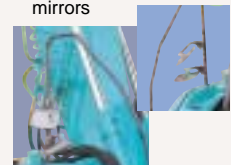

● Rear mirror on the counterweight

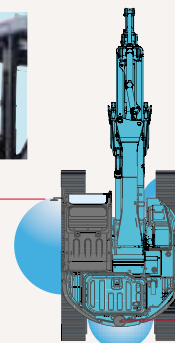

Safety Features That Take Various Scenarios into Consideration

● Firewall separates the pump compartment from the engine ● Hammer for emergency exit ● Handrails meet European standards ● Thermal guard prevents contact with hot components during engine inspections ● Retractable seatbelt requires no manual adjustment ● Travel alarm (optional for NZ) ● Data on attachment position from sensors is analyzed and displayed in the monitor.

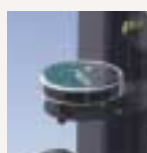

● Level indicator that shows degree of machine tilt (optional for NZ)



● Double slide seat



● Powerful automatic air conditioner



● Two-speaker FM/AM radio with station select



● One-touch lock release simplifies opening and closing front window



● Large cup holder



● Spacious luggage tray



Engine

| Model | MITSUBISHI D04FR-KDP2TAAC |
|---------------------|--|
| Type: | Direct injection, water-cooled, 4-cycle diesel engine with turbocharger, intercooler |
| No. of cylinders: | 4 |
| Bore and stroke: | 102 mm × 130 mm |
| Displacement: | 4,249 L |
| Rated power output: | 74 kW/2,000 min ⁻¹ (ISO14396:2002)* 69.2 kW /2,000 min ⁻¹ (ISO9249:2007) |
| Max. torque: | 375 N·m/1,600 min ⁻¹ (ISO14396:2002)* 359 N·m/1,600 min ⁻¹ (ISO9249:2007) |

*ISO14396 meets EU regulation.



Hydraulic System

| Pump | |
|-----------------------|---|
| Type: | Two variable displacement pumps + 1 gear pump |
| Max. discharge flow: | 2 × 130 L/min, 1 × 20 L/min |
| Relief valve setting | |
| Boom, arm and bucket: | 34.3 MPa {350 kgf/cm ² } |
| Travel circuit: | 34.3 MPa {350 kgf/cm ² } |
| Swing circuit: | 28.0 MPa {285 kgf/cm ² } |
| Control circuit: | 5.0 MPa {50 kgf/cm ² } |
| Pilot control pump: | Gear type |
| Main control valves: | 8-spool |
| Oil cooler: | Air cooled type |



Swing System

| | |
|--------------------------|--|
| Swing motor: | Axial piston motor |
| Brake: | Hydraulic; locking automatically when the swing control lever is in the neutral position |
| Parking brake: | Hydraulic brake |
| Swing speed: | 11.5 min ⁻¹ {rpm} |
| Tail swing radius: | 1,490 mm |
| Min. front swing radius: | 2,000 mm |



Attachments

Backhoe bucket and arm combination

| Use | Backhoe bucket | | | | | | | | Slope finishing bucket |
|---------------------|---------------------------|------|------|------|------|-------|-------|-------|------------------------|
| | Normal digging | | | | | | | | |
| | | | | | | | | | — |
| Bucket capacity | ISO heaped m ³ | 0.24 | 0.31 | 0.38 | 0.45 | 0.50 | 0.57 | 0.70 | 0.52 |
| | Struck m ³ | 0.20 | 0.23 | 0.28 | 0.35 | 0.38 | 0.43 | 0.50 | — |
| Opening width | With side cutter mm | 600 | 700 | 800 | 900 | 1,000 | 1,100 | — | — |
| | Without side cutter mm | 500 | 600 | 700 | 800 | 900 | 1,000 | 1,150 | 1,800 × 900 |
| No. of bucket teeth | | 3 | 3 | 4 | 4 | 5 | 5 | 5 | — |
| Bucket weight | kg | 280 | 300 | 320 | 360 | 390 | 400 | 400 | — |
| Combinations | 2.09 m Short arm | ○ | ○ | ○ | ○ | △ | ◎ | △ | — |
| | 2.38 m Standar arm | ○ | ○ | ○ | ○ | ◎ | △ | — | △ |
| | 2.84 m Long arm | ○ | ○ | ◎ | △ | — | — | — | — |

◎ Std. ○ Recommended △ Loading only

Operating Weight & Ground Pressure

In standard trim, with standard boom, 2.38 m arm, and 0.5 m³ ISO heaped bucket

[] = Long Crawler

| Shaped | | Triple grouser shoes (even height) | | |
|--|-----------------|------------------------------------|----------------------------|----------------------------|
| | | 500 | 600 | 700 |
| Shoe width mm | | 500 | 600 | 700 |
| Overall width of crawler mm | | 2,490 | 2,590 | 2,690 |
| Ground pressure kPa (kgf/cm ²) | | 43 (0.44) [42 (0.43)] | 37 (0.38) [35 (0.36)] | 32 (0.33) [31 (0.31)] |
| Operating weight kg | | 13,800 [13,900] | 14,000 [14,300] | 14,200 [14,500] |
| Dozer (optional) | Weight | Plus 700 kg | Plus 700 kg | Plus 700 kg |
| | Ground pressure | Plus 2.5 kPa* ¹ | Plus 2.1 kPa* ¹ | Plus 1.8 kPa* ¹ |
| Offset boom (optional) | Weight | Plus 600 kg | Plus 600 kg | Plus 600 kg |
| | Ground pressure | Plus 1.9 kPa* ² | Plus 1.6 kPa* ² | Plus 1.3 kPa* ² |

*¹ without offset boom *² without dozer



Travel System

| | |
|------------------------|-----------------------------------|
| Travel motors: | 2 × axial-piston, two-step motors |
| Travel brakes: | Hydraulic brake per motor |
| Parking brakes: | Oil disc brake per motor |
| Travel shoes: | 44 each side |
| Travel speed: | 5.6 / 3.4 km/h |
| Drawbar pulling force: | 139 kN {14,100 kgf} (ISO 7464) |
| Gradeability: | 70 % {35°} |



Cab & Control

Cab

All-weather, sound-suppressed steel cab mounted on the silicon-sealed viscous mounts and equipped with a heavy, insulated floor mat.

Control

Two hand levers and two foot pedals for travel

Two hand levers for excavating and swing

Electric rotary-type engine throttle



Boom, Arm & Bucket

| | |
|-------------------|-------------------|
| Boom cylinders: | 100 mm × 1,092 mm |
| Arm cylinder: | 115 mm × 1,120 mm |
| Bucket cylinders: | 95 mm × 903 mm |



Refilling Capacities & Lubrications

| | |
|------------------------|---|
| Fuel tank: | 200 L |
| Cooling system: | 14 L |
| Engine oil: | 18.5 L |
| Travel reduction gear: | 2 × 2.1 L |
| Swing reduction gear: | 1.65 L |
| Hydraulic oil tank: | 98.5 L tank oil level 140 L hydraulic system |



Working Ranges

Unit: m

| Range | Boom | | | |
|---|------|-----------------|--------------------|----------------|
| | Arm | 4.68 m | | |
| | | Short 2.09 m | Standard 2.38 m | Long 2.84 m |
| a - Max. digging reach | | 8.04 | 8.34 | 8.78 |
| b - Max. digging reach at ground level | | 7.89 | 8.19 | 8.64 |
| c - Max. digging depth | | 5.23 | 5.52 | 5.98 |
| d - Max. digging height | | 8.92 | 9.19 | 9.56 |
| e - Max. dumping clearance | | 6.47 | 6.74 | 7.11 |
| f - Min. dumping clearance | | 2.90 | 2.58 | 2.22 |
| g - Max. vertical wall digging depth | | 4.68 | 4.89 | 5.44 |
| h - Min. swing radius | | 2.07 | 2.00 | 2.40 |
| i - Horizontal digging stroke at ground level | | 3.59 | 4.21 | 4.70 |
| j - Digging depth for 2.4 m (8') flat bottom | | 4.96 | 5.29 | 5.79 |
| Bucket capacity ISO heaped m ³ | | 0.57 | 0.50 | 0.38 |

Digging Force (ISO 6015)

Unit: kN (kgf)

| Arm length | Standard 2.38 m |
|----------------------|--------------------|
| Bucket digging force | 90.1 (9,190) |
| Arm crowding force | 64.4 (6,570) |

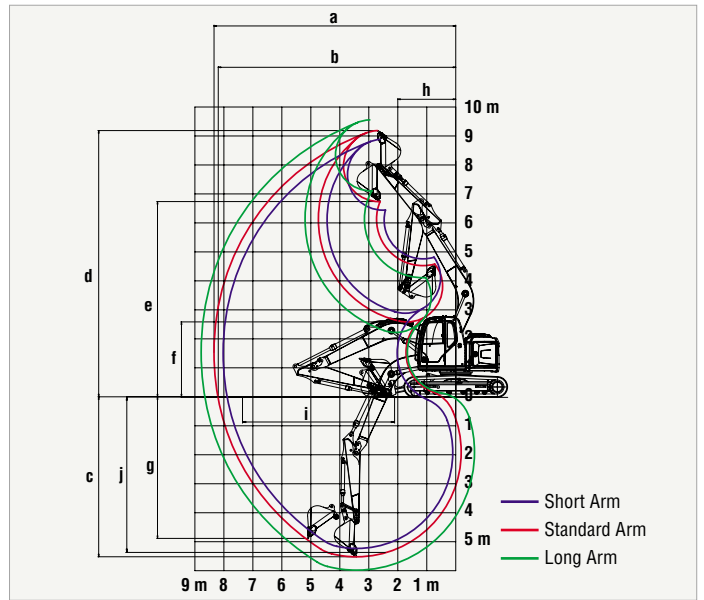

Dimensions

Unit: mm

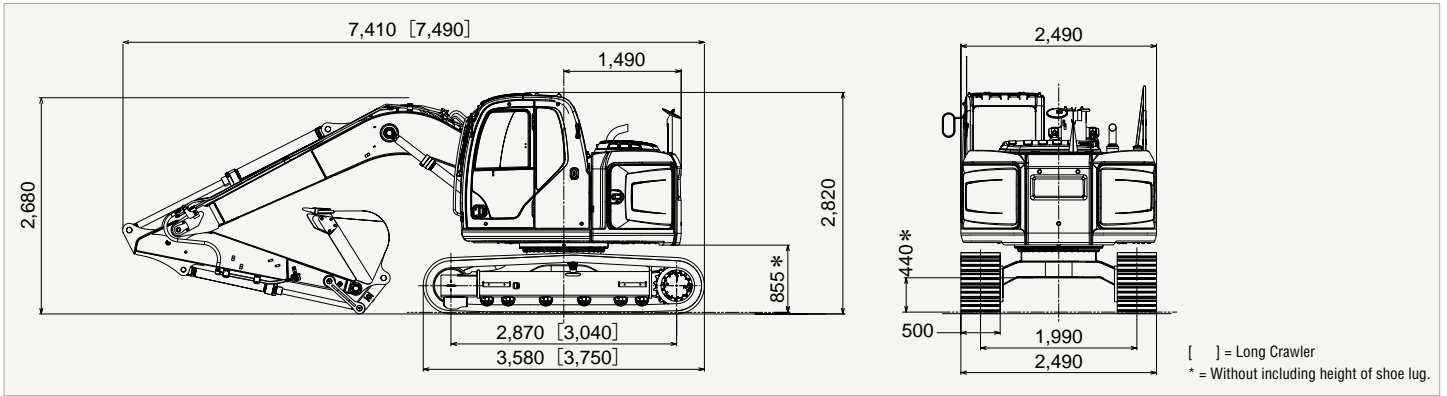

SIDE DIGGING APPLICATION



Offset Boom Specification Working Ranges

Unit: m

| Arm Offset | 2.2 m | | |
|---|----------|-------------|--------------|
| | (Center) | Max. (left) | Max. (right) |
| a - Max. digging reach | 7.57 | 7.15 | 7.14 |
| b - Max. digging reach at ground level | 7.41 | 6.98 | 6.97 |
| c - Max. digging depth | 4.99 | 4.58 | 4.57 |
| d - Max. digging height | 8.15 | 7.81 | 7.80 |
| e - Max. dumping clearance | 5.77 | 5.42 | 5.41 |
| f - Min. dumping clearance | 2.41 | 2.07 | 2.05 |
| g - Max. vertical wall digging depth | 3.61 | 3.25 | 3.24 |
| h - Min. front swing radius | 1.70 | 1.44 | 1.43 |
| Bucket capacity ISO heaped m ³ | | 0.5 | |

Unit: mm

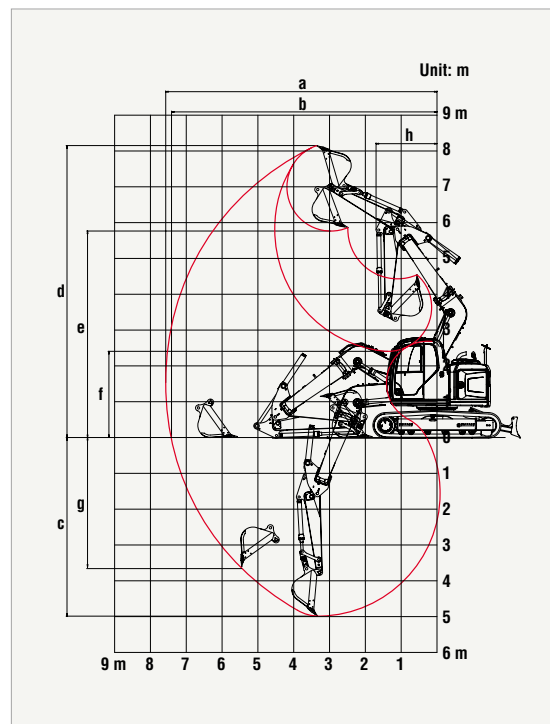
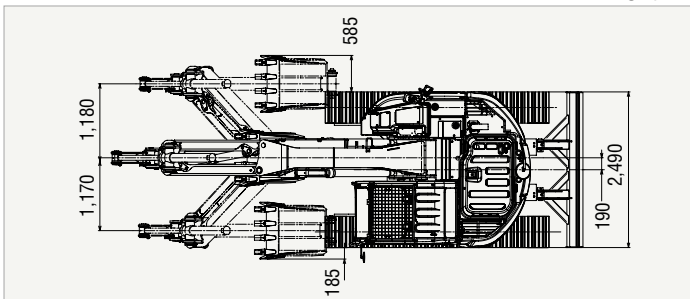

Lifting Capacities

SK135SR

SK135SR-2

SK135SR_{LC}

SK135SR_{LC}-2

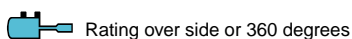
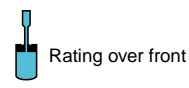
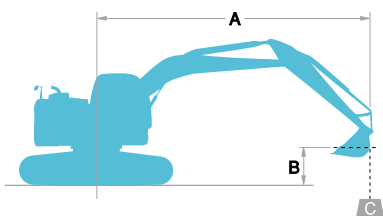

A - Reach from swing centerline to bucket hook

B - Bucket hook height above/below ground

C - Lifting capacities in kilograms











- Max. discharge pressure: 34.3 MPa (350 kg/cm²)











| SK135SR | | Standard Arm: 2.38 m Bucket: 0.5 m ³ ISO heaped 390 kg Shoe: 500 mm Counterweight: 3.4 t | | | | | | | | | | | | |
|---------|----|---|--------|--------|--------|--------|--------|--------|-------|---------------|--|--------|--------|--------|
| B | A | 1.5 m | | 3.0 m | | 4.5 m | | 6.0 m | | At max. reach | | Radius | | |
| | | | | | | | | | | | | | | |
| 7.5 m | kg | | | | | | | | | | | *1,570 | *1,570 | 3.91 m |
| 6.0 m | kg | | | | | *2,980 | *2,980 | | | | | *1,270 | *1,270 | 5.63 m |
| 4.5 m | kg | | | | | *3,250 | 3,190 | *2,640 | 1,890 | | | *1,190 | *1,190 | 6.58 m |
| 3.0 m | kg | | | | *5,740 | *5,740 | *4,000 | 2,960 | 2,840 | 1,800 | | *1,220 | *1,220 | 7.08 m |
| 1.5 m | kg | | | | *8,050 | 4,980 | 4,330 | 2,680 | 2,710 | 1,690 | | *1,340 | 1,210 | 7.23 m |
| G. L. | kg | | | | *7,110 | 4,650 | 4,110 | 2,490 | 2,610 | 1,590 | | *1,590 | 1,220 | 7.06 m |
| -1.5 m | kg | *5,260 | *5,260 | *8,030 | 4,620 | 4,030 | 2,410 | 2,570 | 1,550 | | | *2,090 | 1,360 | 6.53 m |
| -3.0 m | kg | *8,120 | *8,120 | *6,590 | 4,730 | 4,070 | 2,450 | | | | | 2,940 | 1,790 | 5.55 m |
| -4.5 m | kg | | | | *3,640 | *3,640 | | | | | | *2,820 | *2,820 | 3.74 m |

| SK135SR | | Standard Arm: 2.38 m Bucket: 0.5 m ³ ISO heaped 390 kg Shoe: 500 mm Counterweight: 4.0 t | | | | | | | | | | | | |
|---------|----|---|--------|--------|--------|--------|--------|--------|-------|---------------|--|--------|--------|--------|
| B | A | 1.5 m | | 3.0 m | | 4.5 m | | 6.0 m | | At max. reach | | Radius | | |
| | | | | | | | | | | | | | | |
| 7.5 m | kg | | | | | | | | | | | *1,570 | *1,570 | 3.91 m |
| 6.0 m | kg | | | | | *2,980 | *2,980 | | | | | *1,270 | *1,270 | 5.63 m |
| 4.5 m | kg | | | | | *3,250 | *3,250 | *2,640 | 2,120 | | | *1,190 | *1,190 | 6.58 m |
| 3.0 m | kg | | | | *5,740 | *5,740 | *4,000 | 3,290 | 3,130 | 2,030 | | *1,220 | *1,220 | 7.08 m |
| 1.5 m | kg | | | | *8,050 | 5,570 | 4,760 | 3,010 | 3,000 | 1,920 | | *1,340 | *1,340 | 7.23 m |
| G. L. | kg | | | | *7,110 | 5,240 | 4,540 | 2,820 | 2,900 | 1,820 | | *1,590 | 1,400 | 7.06 m |
| -1.5 m | kg | *5,260 | *5,260 | *8,030 | 5,200 | 4,450 | 2,740 | 2,850 | 1,780 | | | *2,090 | 1,570 | 6.53 m |
| -3.0 m | kg | *8,120 | *8,120 | *6,590 | 5,310 | *4,470 | 2,780 | | | | | 3,260 | 2,050 | 5.55 m |
| -4.5 m | kg | | | | *3,640 | *3,640 | | | | | | *2,820 | *2,820 | 3.74 m |











| SK135SR | | Long Arm: 2.84 m Bucket: 0.38 m ³ ISO heaped 320 kg Shoe: 500 mm Counterweight: 3.4 t | | | | | | | | | | | | | |
|---------|----|--|--------|--------|--------|--------|--------|--------|--------|-------|--------|---------------|--------|--------|--------|
| B | A | 1.5 m | | 3.0 m | | 4.5 m | | 6.0 m | | 7.5 m | | At max. reach | | Radius | |
| | | | | | | | | | | | | | | | |
| 7.5 m | kg | | | | | *1,840 | *1,840 | | | | | *1,500 | *1,500 | 4.69 m | |
| 6.0 m | kg | | | | | *2,570 | *2,570 | *1,680 | *1,680 | | | *1,250 | *1,250 | 6.19 m | |
| 4.5 m | kg | | | | | *2,870 | *2,870 | *2,750 | 1,930 | | | *1,180 | *1,180 | 7.06 m | |
| 3.0 m | kg | | | | *4,890 | *4,890 | *3,630 | 3,010 | 2,860 | 1,820 | *1,310 | 1,170 | *1,200 | 1,160 | 7.53 m |
| 1.5 m | kg | | | | *7,390 | 5,120 | 4,370 | 2,710 | 2,720 | 1,690 | 1,860 | 1,120 | *1,290 | 1,070 | 7.67 m |
| G. L. | kg | | | | *7,400 | 4,630 | 4,100 | 2,470 | 2,590 | 1,570 | *1,550 | 1,070 | *1,490 | 1,070 | 7.51 m |
| -1.5 m | kg | *4,540 | *4,540 | 8,200 | 4,520 | 3,980 | 2,360 | 2,530 | 1,510 | | | *1,870 | 1,180 | 7.02 m | |
| -3.0 m | kg | *7,050 | *7,050 | *7,130 | 4,590 | 3,980 | 2,370 | 2,550 | 1,530 | | | 2,480 | 1,490 | 6.12 m | |
| -4.5 m | kg | | | | *4,740 | *4,740 | *2,950 | 2,520 | | | | *2,880 | 2,470 | 4.55 m | |











| SK135SR | | Long Arm: 2.84 m Bucket: 0.38 m ³ ISO heaped 320 kg Shoe: 500 mm Counterweight: 4.0 t | | | | | | | | | | | | | |
|---------|----|--|--------|--------|--------|--------|--------|--------|--------|-------|--------|---------------|--------|--------|--------|
| B | A | 1.5 m | | 3.0 m | | 4.5 m | | 6.0 m | | 7.5 m | | At max. reach | | Radius | |
| | | | | | | | | | | | | | | | |
| 7.5 m | kg | | | | | *1,840 | *1,840 | | | | | *1,500 | *1,500 | 4.69 m | |
| 6.0 m | kg | | | | | *2,570 | *2,570 | *1,680 | *1,680 | | | *1,250 | *1,250 | 6.19 m | |
| 4.5 m | kg | | | | | *2,870 | *2,870 | *2,750 | 2,160 | | | *1,180 | *1,180 | 7.06 m | |
| 3.0 m | kg | | | | *4,890 | *4,890 | *3,630 | 3,340 | *3,060 | 2,050 | *1,310 | *1,310 | *1,200 | *1,200 | 7.53 m |
| 1.5 m | kg | | | | *7,390 | 5,700 | *4,560 | 3,040 | 3,000 | 1,920 | *1,910 | 1,290 | *1,290 | 1,240 | 7.67 m |
| G. L. | kg | | | | *7,400 | 5,220 | 4,530 | 2,800 | 2,880 | 1,800 | *1,550 | 1,250 | *1,490 | 1,240 | 7.51 m |
| -1.5 m | kg | *4,540 | *4,540 | *8,270 | 5,110 | 4,400 | 2,690 | 2,810 | 1,740 | | | *1,870 | 1,370 | 7.02 m | |
| -3.0 m | kg | *7,050 | *7,050 | *7,130 | 5,170 | 4,410 | 2,700 | 2,830 | 1,760 | | | *2,730 | 1,710 | 6.12 m | |
| -4.5 m | kg | | | | *4,740 | *4,740 | *2,950 | 2,850 | | | | *2,880 | 2,800 | 4.55 m | |

| SK135SR ^{LC} | | Standard Arm: 2.38 m Bucket: 0.5 m ³ ISO heaped 390 kg Shoe: 500 mm Counterweight: 3.4 t | | | | | | | | | | | |
|-----------------------|----|---|---|---|---|---|---|---|---|---|---|--------|--------|
| A \ B | | 1.5 m | | 3.0 m | | 4.5 m | | 6.0 m | | At max. reach | | Radius | |
| | |  |  |  |  |  |  |  |  |  |  | | |
| 7.5 m | kg | | | | | | | | | | *1,570 | *1,570 | 3.91 m |
| 6.0 m | kg | | | | | *2,980 | *2,980 | | | | *1,270 | *1,270 | 5.63 m |
| 4.5 m | kg | | | | | *3,250 | 3,240 | *2,640 | 1,930 | | *1,190 | *1,190 | 6.58 m |
| 3.0 m | kg | | | *5,740 | *5,740 | *4,000 | 3,010 | 3,150 | 1,840 | | *1,220 | *1,220 | 7.08 m |
| 1.5 m | kg | | | *8,050 | 5,080 | 4,840 | 2,740 | 3,020 | 1,730 | | *1,340 | 1,240 | 7.23 m |
| G. L. | kg | | | *7,110 | 4,750 | 4,620 | 2,540 | 2,920 | 1,630 | | *1,590 | 1,250 | 7.06 m |
| -1.5 m | kg | *5,260 | *5,260 | *8,030 | 4,720 | 4,530 | 2,470 | 2,870 | 1,590 | | *2,090 | 1,400 | 6.53 m |
| -3.0 m | kg | *8,120 | *8,120 | *6,590 | 4,820 | *4,470 | 2,500 | | | | *3,290 | 1,840 | 5.55 m |
| -4.5 m | kg | | | *3,640 | *3,640 | | | | | | *2,820 | *2,820 | 3.74 m |

| SK135SR ^{LC} | | Standard Arm: 2.38 m Bucket: 0.5 m ³ ISO heaped 390 kg Shoe: 500 mm Counterweight: 4.0 t | | | | | | | | | | | |
|-----------------------|----|---|---|---|---|---|---|---|---|---|---|--------|--------|
| A \ B | | 1.5 m | | 3.0 m | | 4.5 m | | 6.0 m | | At max. reach | | Radius | |
| | |  |  |  |  |  |  |  |  |  |  | | |
| 7.5 m | kg | | | | | | | | | | *1,570 | *1,570 | 3.91 m |
| 6.0 m | kg | | | | | *2,980 | *2,980 | | | | *1,270 | *1,270 | 5.63 m |
| 4.5 m | kg | | | | | *3,250 | *3,250 | *2,640 | 2,160 | | *1,190 | *1,190 | 6.58 m |
| 3.0 m | kg | | | *5,740 | *5,740 | *4,000 | 3,340 | *3,290 | 2,070 | | *1,220 | *1,220 | 7.08 m |
| 1.5 m | kg | | | *8,050 | 5,660 | *4,860 | 3,070 | 3,320 | 1,960 | | *1,340 | *1,340 | 7.23 m |
| G. L. | kg | | | *7,110 | 5,330 | 5,070 | 2,870 | 3,220 | 1,860 | | *1,590 | 1,440 | 7.06 m |
| -1.5 m | kg | *5,260 | *5,260 | *8,030 | 5,300 | 4,980 | 2,800 | 3,170 | 1,820 | | *2,090 | 1,610 | 6.53 m |
| -3.0 m | kg | *8,120 | *8,120 | *6,590 | 5,410 | *4,470 | 2,830 | | | | *3,290 | 2,090 | 5.55 m |
| -4.5 m | kg | | | *3,640 | *3,640 | | | | | | *2,820 | *2,820 | 3.74 m |

Side Digging Application

| SK135SR | | Offset Arm: 2.20 m Bucket: 0.5 m ³ ISO heaped 390 kg Shoe: 500 mm Counterweight: 3.4 t | | | | | | | | | | | |
|---------|----|---|---|---|---|---|---|---|---|---|---|--------|--------|
| A \ B | | 1.5 m | | 3.0 m | | 4.5 m | | 6.0 m | | At max. reach | | Radius | |
| | |  |  |  |  |  |  |  |  |  |  | | |
| 6.0 m | kg | | | | | | | | | | *1,990 | *1,990 | 4.42 m |
| 4.5 m | kg | | | | | *3,170 | *3,170 | | | | *1,960 | *1,960 | 5.58 m |
| 3.0 m | kg | | | *5,280 | *5,280 | *3,790 | 2,920 | 2,770 | 1,710 | | *2,140 | 1,610 | 6.17 m |
| 1.5 m | kg | | | *7,440 | 4,770 | 4,240 | 2,560 | 2,620 | 1,570 | | 2,370 | 1,410 | 6.34 m |
| G. L. | kg | *3,880 | *3,880 | 7,960 | 4,260 | 3,940 | 2,290 | 2,480 | 1,450 | | 2,390 | 1,390 | 6.15 m |
| -1.5 m | kg | *5,900 | *5,900 | *7,690 | 4,190 | 3,820 | 2,190 | | | | 2,760 | 1,590 | 5.53 m |
| -3.0 m | kg | *8,900 | *8,900 | *6,180 | 4,360 | | | | | | 4,180 | 2,410 | 4.31 m |

| SK135SR | | Offset Arm: 2.20 m Bucket: 0.5 m ³ ISO heaped 390 kg Shoe: 500 mm Counterweight: 4.0 t | | | | | | | | | | | |
|---------|----|---|---|---|---|---|---|---|---|---|---|--------|--------|
| A \ B | | 1.5 m | | 3.0 m | | 4.5 m | | 6.0 m | | At max. reach | | Radius | |
| | |  |  |  |  |  |  |  |  |  |  | | |
| 6.0 m | kg | | | | | | | | | | *1,990 | *1,990 | 4.42 m |
| 4.5 m | kg | | | | | *3,170 | *3,170 | | | | *1,960 | *1,960 | 5.58 m |
| 3.0 m | kg | | | *5,280 | *5,280 | *3,790 | 3,250 | *2,870 | 1,940 | | *2,140 | 1,840 | 6.17 m |
| 1.5 m | kg | | | *7,440 | 5,360 | *4,580 | 2,890 | 2,900 | 1,800 | | *2,530 | 1,620 | 6.34 m |
| G. L. | kg | *3,880 | *3,880 | *8,160 | 4,850 | 4,360 | 2,620 | 2,770 | 1,680 | | 2,660 | 1,610 | 6.15 m |
| -1.5 m | kg | *5,900 | *5,900 | *7,690 | 4,780 | 4,250 | 2,520 | | | | 3,080 | 1,850 | 5.53 m |
| -3.0 m | kg | *8,900 | *8,900 | *6,180 | 4,940 | | | | | | *4,270 | 2,760 | 4.31 m |

Notes:

- Do not attempt to lift or hold any load that is greater than these lift capacities at their specified lift point radius and heights. Weight of all accessories must be deducted from the above lift capacities.
- Lift capacities are based on machine standing on level, firm, and uniform ground. User must make allowance for job conditions such as soft or uneven ground, out of level conditions, side loads, sudden stopping of loads, hazardous conditions, experience of personnel, etc.
- Bucket lift hook defined as lift point.
- The above lifting capacities are in compliance with SAE J/ISO 10567. They do not exceed 87% of hydraulic lifting capacity or 75% of tipping load. Lifting capacities marked with an asterisk (*) are limited by hydraulic capacity rather than tipping load.
- Operator should be fully acquainted with the Operator's and Maintenance Instructions before operating this machine. Rules for safe operation of equipment should be adhered to at all times.
- Lift capacities apply to only machine as originally manufactured and normally equipped by KOBELCO CONSTRUCTION MACHINERY CO., LTD.

STANDARD EQUIPMENT

ENGINE

- Engine, MITSUBISHI D04FR-KDP2TAAC, Diesel engine with turbocharger and intercooler
- Automatic engine deceleration
- Auto Idle Stop (AIS)
- Batteries (2 x 12V - 80Ah)
- Starting motor (24V - 5 kW), 50 amp alternator
- Automatic engine low idle for low engine oil pressure
- Engine oil pan drain cock
- Double element air cleaner

CONTROL

- Working mode selector (H-mode ,S-mode)

SWING SYSTEM & TRAVEL SYSTEM

- Swing rebound prevention system
- Straight propel system
- Two-speed travel with automatic shift down
- Sealed & lubricated track links
- Grease-type track adjusters
- Automatic swing brake

MIRRORS & LIGHTS

- Four rearview mirrors
- Two front working lights

CAB & CONTROL

- Two control levers, pilot-operated
- Tow eyes
- Horn, electric
- Integrated left-right slide-type control box
- Ashtray
- Cigarette lighter
- Cab light (interior)
- Coat hook
- Luggage tray
- Large cup holder
- Detachable two-piece floor mat
- 7-way adjustable suspension seat
- Retractable seatbelt
- Headrest
- Handrails
- Heater and defroster
- Intermittent windshield wiper with double-spray washer
- Skylight
- Tinted safety glass
- Pull-type front window and removable lower front window
- Easy-to-read multi-display monitor
- Automatic air conditioner
- Emergency escape hammer
- Radio, AM/FM Stereo with speakers
- Travel alarm (optional for NZ)
- Heightlizer for control box
- Gear pump (optional for NZ)
- Level indicator (optional for NZ)

OPTIONAL EQUIPMENT

- Dozer blade
- Wide range of buckets
- Various optional arms
- Wide range of shoes
- Boom safety valve
- Arm safety valve
- Front-guard protective structures (May interfere with bucket action)
- Additional hydraulic circuit
- Add-on counterweight
- Cab light
- Control pattern changer (2 way, 4 way)

Note: Standard and optional equipment may vary. Consult your KOBELCO dealer for specifics.

Note: This catalog may contain attachments and optional equipment that are not available in your area. And it may contain photographs of machines with specifications that differ from those of machines sold in your areas. Please consult your nearest KOBELCO distributor for those items you require. Due to our policy of continuous product improvements all designs and specifications are subject to change without advance notice. Copyright by **KOBELCO CONSTRUCTION MACHINERY CO., LTD.** No part of this catalog may be reproduced in any manner without notice.

KOBELCO CONSTRUCTION MACHINERY CO., LTD.

17-1, Higashigotanda 2-chome, Shinagawa-ku, Tokyo 141-8626 JAPAN
Tel: +81 (0) 3-5789-2146 Fax: +81 (0) 3-5789-2135
www.kobelco-kenki.co.jp/english_index.html

Inquiries To: