

STANDARD EQUIPMENT

ENGINE

- Engine, MITSUBISHI D04FR-74kW, Diesel engine with turbocharger and intercooler
- Automatic engine deceleration
- Auto Idle Stop (AIS)
- Batteries (2 x 12V - 96Ah)
- Starting motor (24V - 5 kW), 50 amp alternator
- Removable clean-out screen for radiator
- Automatic engine shut-down for low engine oil pressure
- Engine oil pan drain valve
- Double element air cleaner

CONTROL

- Working mode selector (H-mode and S-mode)

SWING SYSTEM & TRAVEL SYSTEM

- Swing rebound prevention system
- Straight propel system
- Two-speed travel with automatic shift down
- Sealed & lubricated track links
- Grease-type track adjusters
- Automatic swing brake

HYDRAULIC

- Arm regeneration system
- Aluminum hydraulic oil cooler

MIRRORS & LIGHTS

- Two rearview mirrors
- Two front and two rear working lights
- Swing flashers
- Two cab working lights

CAB & CONTROL

- Two control levers, pilot-operated
- Tow eyes
- Horn, electric
- Integrated left-right slide-type control box
- Cab, all-weather sound suppressed type
- Ashtray
- Cigarette lighter
- Cab light (interior)
- Coat hook
- Luggage tray
- Large cup holder
- Detachable two-piece floor mat
- Double slide seat
- Adjustable suspension seat
- Retractable seatbelt
- Headrest
- Handrails
- Heater and defroster
- Intermittent windshield wiper with double-spray washer
- Skylight
- Tinted safety glass
- Pull-type front window and removable lower front window
- Easy-to-read multi-display monitor
- Automatic air conditioner
- Arm rest
- Radio, AM/FM stereo with speakers

OPTIONAL EQUIPMENT

- Wide range of buckets
- Various optional arms
- Wide range of shoes
- Additional hydraulic circuit
- Additional counterweight
- Cab light (exterior)

Note: Standard and optional equipment may vary. Consult your KOBELCO dealer for specifics.

Hydraulic Excavators

ACERA
GEOSPEC
SUPER
SK130
SK140^{LC}

- Bucket Capacity:
0.24 – 0.70 m³ ISO heaped
- Engine Power:
74 kW {100 PS}/2,000 min⁻¹{rpm}
(ISO14396)
- Operating Weight:
12,800 kg–SK130
13,200 kg–SK140LC

Note: This catalog may contain attachments and optional equipment that are not available in your area. And it may contain photographs of machines with specifications that differ from those of machines sold in your areas. Please consult your nearest KOBELCO distributor for those items you require. Due to our policy of continuous product improvements all designs and specifications are subject to change without advance notice. Copyright by **KOBELCO CONSTRUCTION MACHINERY CO., LTD.** No part of this catalog may be reproduced in any manner without notice.

KOBELCO CONSTRUCTION MACHINERY CO., LTD.

17-1, Higashigotanda 2-chome, Shinagawa-ku, Tokyo 141-8626 JAPAN
Tel: +81 (0) 3-5789-2146 Fax: +81 (0) 3-5789-2135
www.kobelco-kenki.co.jp/english_index.html

Inquiries To:

Bulletin No. ACERA GEOSPEC SUPER SK130/SK140LC-MONGOL-101
2011110000 Printed in Japan

SK130/SK140LC Models Join the ACERA GEOSPEC Series!

ACERA GEOSPEC Series: The Power Wave of Change

The new ACERA GEOSPEC series, developed using KOBELCO's most advanced technologies, features hydraulic excavators that offer superlative solutions for all the requirements of today's construction industry. Their streamlined power drives a work performance that maximizes capacity and minimizes waste, offering a completely new working style while taking care for the environment to a new level.

SK130/SK140LC models have now joined the ACERA GEOSPEC series. They're fitted with a newly designed power plant that delivers high productivity with the low fuel consumption that is the outstanding feature of the ACERA GEOSPEC series. In basic performance, too, they meet all the latest expectations: a comfortable operating space and controls that create no stress even over the longest jobs; a tough, reliable body and attachment; easy maintenance. The SK130 /SK140LC models make their debut as great little money-earners in the ACERA GEOSPEC series.



NEXT-3E



Pursuing the "Three E's"

The Perfection of Next-Generation, Network Performance

Enhancement

Greater Performance Capacity

- New hydraulic circuitry minimizes pressure loss
- High-efficiency, electronically controlled Common Rail Fuel Injection Engine
- Powerful travel and arm/bucket digging force

Economy

Improved Cost Efficiency

- Advanced power plant that reduces fuel consumption
- Easy maintenance that reduces upkeep costs
- High structural durability and reliability that retain machine value longer

Environment

Features That Go Easy on the Earth

- Meets the latest exhaust emission standards
- Auto Idle Stop as standard equipment
- Noise reduction measures (with improvement of the sound quality) minimize noise and vibration

The GEOSPEC Difference: Efficient Performance!

Popular for its outstanding fuel economy, the Acera Geospec series now features 13-ton class machines



Fuel Consumption
↓ **10 %** decrease in fuel consumption even when performing more work volume. (S-mode)
*Compared with other KOBELCO 13-ton class machines

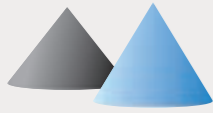

Work Volume
↑ **3 %** increase in work volume using the same amount of fuel. (S-mode)
*Compared with other KOBELCO 13-ton class machines

“Top-Class” Powerful Digging

*Max. arm crowding force: **64.4 kN** {6.6 tf}

*Max. bucket digging force: **90.1 kN** {9.2 tf}

Powerful Travel

Travel Speed: **5.6/3.4 km/h**

Drawbar pulling force: **139 kN** {14.2 tf}

Greater Swing Power, Shorter Cycle Times

Swing torque: **39.9 kN**

Swing speed: **11.0 min⁻¹**

Significant Extension of Continuous Working Hours

The combination of a large-capacity fuel tank and excellent fuel efficiency delivers an impressive 37%* increase in continuous operation hours.

Fuel tank: **275 L**
37 % ↑

*Compared with other KOBELCO 13-ton class machines

Light Lever Operation

Lighter levers mean less operator fatigue over long hours of operation.

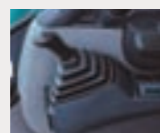

Photos in this catalog are Japanese specs.

NEXT-3E Technology Next-Generation Electronic Engine Control

The high-pressure, common-rail fuel-injection engine features a cooled EGR (Exhaust Gas Recirculation) device that lowers the air intake temperature to keep the oxygen concentration down. The multiple injection system features adjustable control to maximize fuel efficiency and provides powerful medium/low-speed torque. The result is a highly fuel-efficient engine that greatly reduces emissions of PM (Particulate Matter) and NOx into the atmosphere.



Simple Select: Two Digging Modes

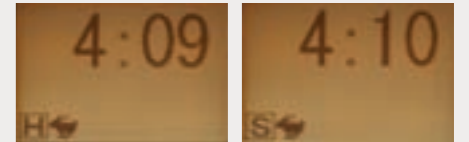

H-Mode For heavy duty when a higher performance level is required.

S-Mode For normal operations with lower fuel consumption.

Optional N&B (crusher and breaker)

The operator selects the desired mode from inside the cab, and the selector valve automatically configures the machine accordingly.

Optional Attachment Mode Selector Switch

There's a choice of three different hydraulic circuits, to accommodate bucket, crusher or breaker, and the desired attachment mode can be selected with a switch, which automatically configures the selector valve. All attachment modes can be used in either S-mode or H-mode.



Seamless, Smooth Combined Operations

The GEOSPEC machines have inherited the various systems that make inching and combined operations easy and accurate, with further refinements that make a good thing even better. Leveling and other combined operations can be carried out with graceful ease.

- Electronic Active Control System
- Arm regeneration system
- Boom lowering system
- Variable swing priority system
- Swing rebound prevention system

NEXT-3E Technology Total Tuning Through Advanced ITCS Control

The next-generation engine control is governed by a new version of ITCS, which responds quickly to sudden changes in hydraulic load to ensure that the engine runs as efficiently as possible with a minimum of wasted output.

ITCS ITCS (Intelligent Total Control System) is an advanced, computerized system that provides comprehensive control of all machine functions.

*The value shows results from actual measurements taken by KOBELCO when compared with other KOBELCO 13-ton class machines.

The GEOSPEC Difference:

The Value and Quality of Sturdy Construction!

Standardized Attachment Strength

Every part of the attachment features cast or forged components. Together, the reinforced boom, heavy-duty arm and reinforced bucket offer superlative durability and enhanced reliability.

Pre-air Cleaner

The pre-air cleaner prolongs a replacement cycle of main air cleaner.



Rock guard (optional)

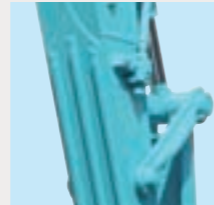

Reinforced bucket

Emergency Acceleration (Dial) Permits Continued Operation in the Unlikely Event of Malfunction (Optional)



If unexpected trouble is experienced with the ITCS mechatronic control system, the machine can still be operated using the emergency acceleration system. Digging modes are also automatically relayed to an emergency system so that digging can continue temporarily until a service person arrives to repair the primary system.

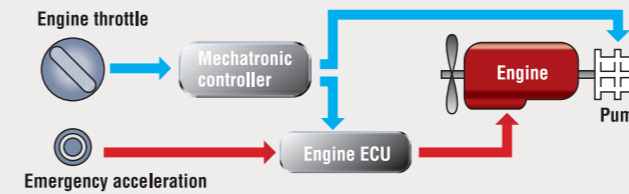

The GEOSPEC Difference:

Designed for the Environment and the Future!

Meets Standard Values Set by Emissions Regulations

The engine used in the GEOSPEC machines represents the crystallization of various cutting-edge technologies that minimize the emission of PM (Particulate Matter), NOx, black smoke, and other emissions, thus meeting all internationally recognized environmental regulations, including US EPA Tier III, NRMM (Europe) Stage IIIA, and Act on Regulation, Etc. of Emissions from Non-road Special Motor Vehicles (Japan).

Auto Idle Stop Provided as Standard Equipment

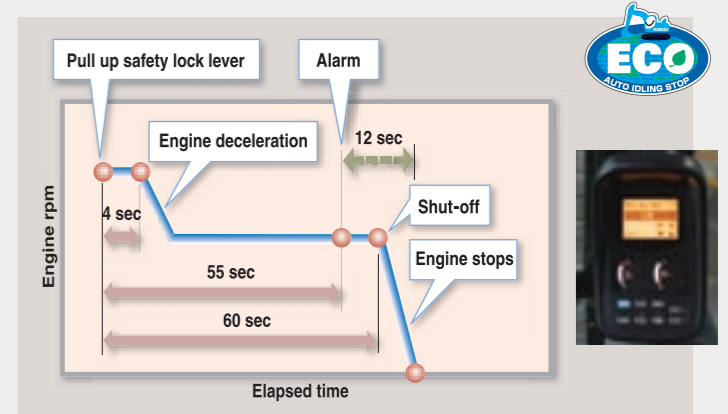

This function saves fuel and cuts emissions by shutting down the engine automatically when the machine is on stand by. It also stops the hourmeter, which helps to retain the machine's asset value.

Automatic Acceleration/Deceleration Function Reduces Engine Speed

Engine speed is automatically reduced when the control lever is placed in neutral, effectively saving fuel and reducing noise and exhaust emissions. The engine quickly returns to full speed when the lever is moved out of neutral.

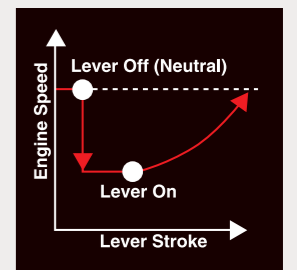

Durability That Retains Machine Value Five and Ten Years in the Future

- Improved heat resistance in the swing motor, cylinders and other hydraulic components
- New operator's seat covered by durable material
- High-quality urethane paint
- Easily repaired bolted hand rails

Reinforced Crawler Shoes

The diameter of the track link pins has been made a size larger for even greater strength.

Reinforced upper and lower frames

The front section of the upper frame and the entire lower frame are constructed of thicker steel plate. As a result, the durability of the machine body is higher than other KOBELCO machines in the 13 ton class.

Low Noise Level and Mild Sound Quality

The electronically controlled common-rail engine has a unique fuel injection system that runs quietly. Also, the hydraulic pumps have been redesigned to produce a more pleasant sound during pressure relief.

Meets EMC (Electromagnetic Compatibility) Standards in Europe.

Measures have been taken to ensure that the GEOSPEC machines do not cause electro-magnetic interference.

Photos in this catalog are Japanese specs.

The GEOSPEC Difference:

“On the Ground” Maintenance!

Comfortable "On the Ground" Maintenance



The machine layout was designed with easy inspection and maintenance in mind.

Access through the right side cover

A new fuel filter system has been installed that can handle the most punishing conditions. It now has a pre-filter (with built-in water separator), an ultra-fine 4-micron main filter, and an additional third filter, to ensure complete removal of dust and other impurities in the fuel.

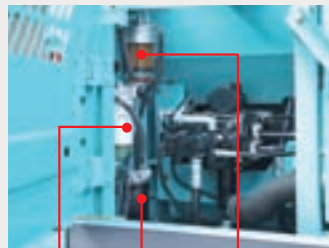

Main fuel filter Third filter Pre-fuel filter (with built-in water separator)



Main fuel filter

Quick Oil Drain Valves for Quick Maintenance



Quick drain valve



Fuel drain valve

More Efficient Maintenance Inside the Cab



● Detachable two-piece floor mat with handles for easy removal. A floor drain is located under the mat.



● Easy-access fuse box. More finely differentiated fuses make it easier to locate malfunctions.

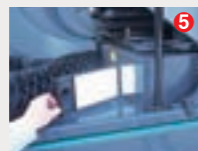

● Air conditioner filter can be easily removed without tools for cleaning.



● Hour meter can be checked while standing on the ground.

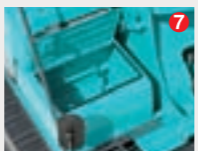

● Large-capacity tool box can hold up to two pails.



● Special crawler frame design is easily cleaned of mud.

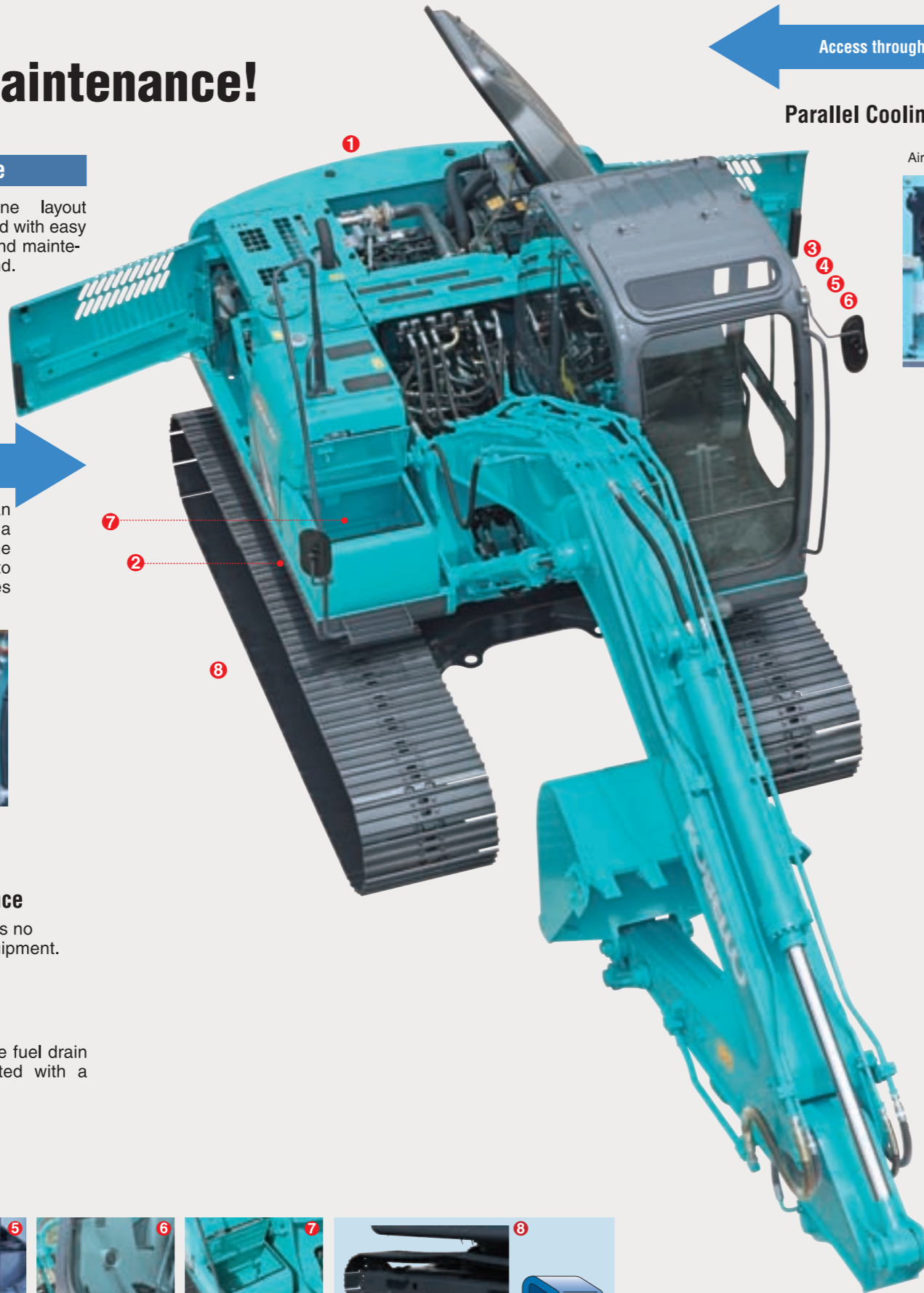

Access through the left side cover

Parallel Cooling Units Are Easy to Clean

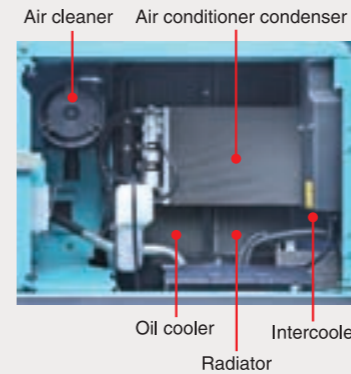

Highly Durable Super-fine Filter



● Super-fine filter

The high-capacity hydraulic oil filter incorporates glass fiber with superior cleaning power and durability. With a replacement cycle of 1,000 hours and a construction that allows replacement of the filter element only, it's both highly effective and highly economical.

Double-Element Air Cleaner as Standard



The large-capacity element features a double-filter structure that keeps the engine running clean even in dusty environments.

Air cleaner (double element)

Monitor Display with Essential Information for Accurate Maintenance Checks



- Displays only the maintenance information that's needed, when it's needed.
- Self-diagnostic function that provides early-warning detection and display of electrical system malfunctions.
- Record previous breakdowns, including irregular and transient malfunctions.

Choice of 16 Languages for Monitor Display

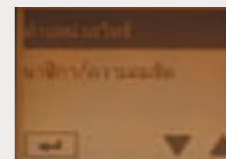

With messages including those requiring urgent action displayed in the local language, users in all parts of the world can work with greater peace of mind.

充電不良	Lichtmaschine defekt	CHARGE ERROR	CHARGE ERROR
Chinese	German	English	English (US)
ERREUR DE CHARGE	PENGISIAN BATT. RUSAK		ERRORE DI CARICA
French	Indonesian	ISO	Italian
チャージ	KESALAHAN CAS	ဓားရောင်းပုံပါ	ERRO DE CARGA
Japanese	Malay	Myanmar (Brumee)	Portuguese
ERROR EN CARGA	தவறாக திணித்தல்	အမှားအယွင်း	Sạc Điện Bị Lỗi
Spanish	Tamil	Thai	Vietnamese

Photos in this catalog are Japanese specs.

The GEOSPEC Difference:

Designed from the Operator's Point of View



Big Cab Same as Larger Class Machines

The "Big Cab" has the same width and height as the cabs installed on much larger machines. With more space to the front and rear of the operator, it feels more roomy, and the larger area of floor space means greater comfort from the feet up. The operator has plenty of space in front for easy, comfortable operation, with ample foot room.

Excellent Visibility

The wide, open view in front combines with minimized blind spots around the machine for greater onsite safety.



- Reinforced green glass meets European standards
- New "rise-up" wipers keep the view clear and clean
- Broad wiper area improves visibility in bad weather
- Rearview mirrors mounted both to the right and left improve safety in back
- Rear-mounted mirror eliminates counterweight blind spot

Reduced Vibration for Fatigue-Free Operation

The rigid cab construction and liquid-filled viscous cab mounts minimize cab vibration. In addition, the use of new lower rollers on the crawlers cuts travel vibration in half compared with previous models.

Newly Designed Information Display Prioritizes Visual Recognition



The analog gauge provides information that's easy to read regardless of the operating environment. The information display screen has been enlarged, and a visor is attached to further enhance visibility.



Creating a Comfortable Operating Environment



- Seat can be reclined to horizontal position



- Double slide seat
- Powerful automatic air conditioner
- Spacious luggage tray



- One-touch lock release simplifies opening and closing the front window
- Large cup holder

The GEOSPEC Difference: Imagining Possible Scenarios and Preparing in Advance

Cab Brackets



The SK130/SK140LC has a safety rating equivalent to FOPS level 1. In addition to the standard roof guard, optional front and head guards are available. They can be easily attached with bolts to the standard cab brackets.

Safety Features That Take Various Scenarios into Consideration



- Firewall separates the pump compartment from the engine



- Hammer for emergency exit



- Swing flashers/rear working lights

- Thermal guard prevents contact with hot components during engine inspections
- Hand rails meet European standards
- Retractable seatbelt requires no manual adjustment

Other Features



- Two cab working lights



- Adjustable suspension seat

Engine

Model	MITSUBISHI D04FR-74kW
Type:	Direct injection, water-cooled, 4-cycle diesel engine with turbocharger, intercooler
No. of cylinders:	4
Bore and stroke:	102 mm x 130 mm
Displacement:	4,249 L
Rated power output:	74 kW/2,000 min ⁻¹ (ISO14396: Without Fan)* 69.2 kW/2,000 min ⁻¹ (ISO9249: With Fan)
Max. torque:	375 N·m/1,600 min ⁻¹ (ISO14396: Without Fan)* 359 N·m/1,600 min ⁻¹ (ISO9249: With Fan)

*Previous indication

Hydraulic System

Pump	
Type:	Two variable displacement pumps + 1 gear pump
Max. discharge flow:	2 x 130 L/min, 1 x 20 L/min
Relief valve setting	
Boom, arm and bucket:	34.3 MPa {350 kgf/cm ² }
Travel circuit:	34.3 MPa {350 kgf/cm ² }
Swing circuit:	28.0 MPa {285 kgf/cm ² }
Control circuit:	5.0 MPa {50 kgf/cm ² }
Pilot control pump:	Gear type
Main control valves:	8-spool
Oil cooler:	Air cooled type

Swing System

Swing motor:	Axial piston motor
Brake:	Hydraulic; locking automatically when the swing control lever is in the neutral position
Parking brake:	Hydraulic brake
Swing speed:	11.0 min ⁻¹ {rpm}
Tail swing radius:	2,190 mm
Min. front swing radius:	2,620 mm

Attachments

Backhoe bucket and arm combination

Use	Backhoe bucket							Slope finishing bucket	
	Normal digging								
								—	
Bucket capacity	ISO heaped m ³	0.24	0.31	0.38	0.45	0.50	0.57	0.70	0.52
	Struck m ³	0.20	0.23	0.28	0.35	0.38	0.43	0.50	—
Opening width	With side cutter mm	590	700	800	900	1,000	1,100	—	—
	Without side cutter mm	500	600	700	820	900	1,000	1,150	1,800 x 900
No. of bucket teeth		3	3	4	4	5	5	5	—
Bucket weight	kg	280	300	320	360	390	400	400	—
Combinations	2.09 m Short arm	○	○	○	○	○	⊙	△	—
	2.38 m Standard arm	○	○	○	○	⊙	△/○*	—	△
	2.84 m Long arm	○	○	⊙	△	—	—	—	—

◎ Std. ○ Recommended △ Loading only * When equipped with the additional counterweight.

Travel System

Travel motors:	2 x axial-piston, two-step motors
Travel brakes:	Hydraulic brake per motor
Parking brakes:	Oil disc brake per motor
Travel shoes:	44 each side (SK130) 46 each side (SK140LC)
Travel speed:	5.6/3.4 km/h
Drawbar pulling force:	139 kN {14,200 kgf} (ISO7464)
Gradeability:	70 % {35°}

Cab & Control

Cab	
All-weather, sound-suppressed steel cab mounted on the silicon-sealed viscous mounts and equipped with a heavy, insulated floor mat.	
Control	
Two hand levers and two foot pedals for travel	
Two hand levers for excavating and swing	
Electric rotary-type engine throttle	

Boom, Arm & Bucket

Boom cylinders:	100 mm x 1,092 mm
Arm cylinder:	115 mm x 1,120 mm
Bucket cylinder:	95 mm x 903 mm

Refilling Capacities & Lubrications

Fuel tank:	275 L
Cooling system:	14 L
Engine oil:	18.5 L
Travel reduction gear:	2 x 2.1 L
Swing reduction gear:	1.65 L
Hydraulic oil tank:	101 L tank oil level 172 L hydraulic system

Working Ranges

Range	Arm	4.68 m		
		Short 2.09 m	Standard 2.38 m	Long 2.84 m
a - Max. digging reach		8.04	8.34	8.78
b - Max. digging reach at ground level		7.89	8.19	8.64
c - Max. digging depth		5.23	5.52	5.98
d - Max. digging height		8.27	8.50	8.81
e - Max. dumping clearance		5.85	6.09	6.39
f - Min. dumping clearance		2.53	2.23	1.79
g - Max. vertical wall digging depth		4.68	4.88	5.55
h - Min. swing radius		2.61	2.62	2.75
i - Horizontal digging stroke at ground level		3.59	4.21	4.70
j - Digging depth for 2.4 m (8') flat bottom		4.97	5.29	5.79
Bucket capacity ISO heaped m ³		0.57	0.52	0.38

Unit: m

Digging Force (ISO 6015)

Arm length	Short 2.09 m	Standard 2.38 m	Long 2.84 m
Bucket digging force	90.1 {9.2}	90.1 {9.2}	90.1 {9.2}
Arm crowding force	71.9 {7.3}	64.4 {6.6}	58.1 {5.9}

Unit: kN (tf)

Dimensions

Arm length	Short 2.09 m	Standard 2.38 m	Long 2.84 m
A Overall length	7,810	7,790	7,790
B Overall height (to top of boom)	2,730	2,710	3,080
C Overall width	2,490	2,490	2,490
D Overall height (to top of cab)	2,870	2,870	2,870
E Ground clearance of rear end*	910	910	910
F Ground clearance*	440	440	440

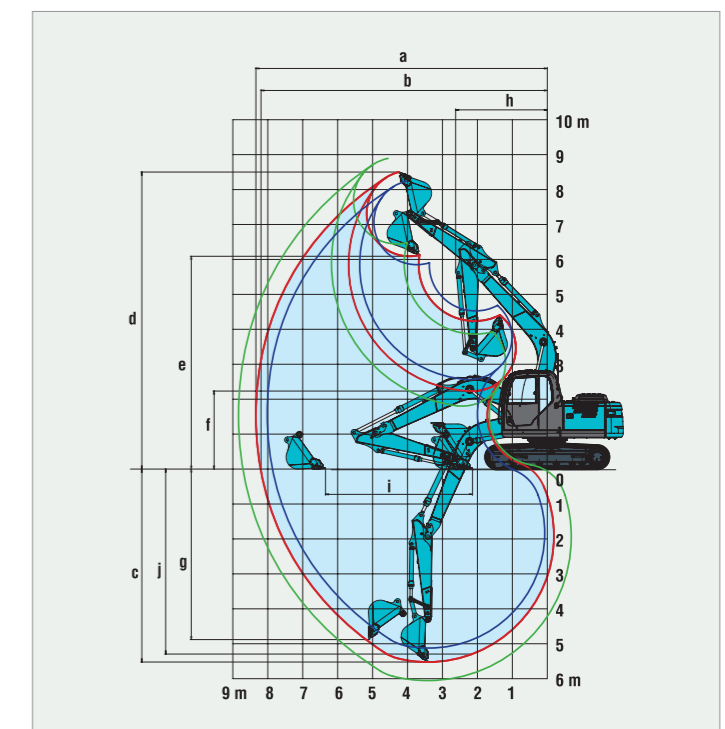

— Short Arm
— Standard Arm
— Long Arm

Unit: mm				
G Tail swing radius		2,190	2,190	2,190
G' Distance from center of swing to rear end		2,180	2,180	2,180
H Tumbler distance	SK130	2,870	2,870	2,870
	SK140LC	3,040	3,040	3,040
I Overall length of crawler	SK130	3,580	3,580	3,580
	SK140LC	3,750	3,750	3,750
J Track gauge		1,990	1,990	1,990
K Shoe width		500/600/700		
L Overall width of upperstructure		2,490	2,490	2,490

* Without including height of shoe lug.

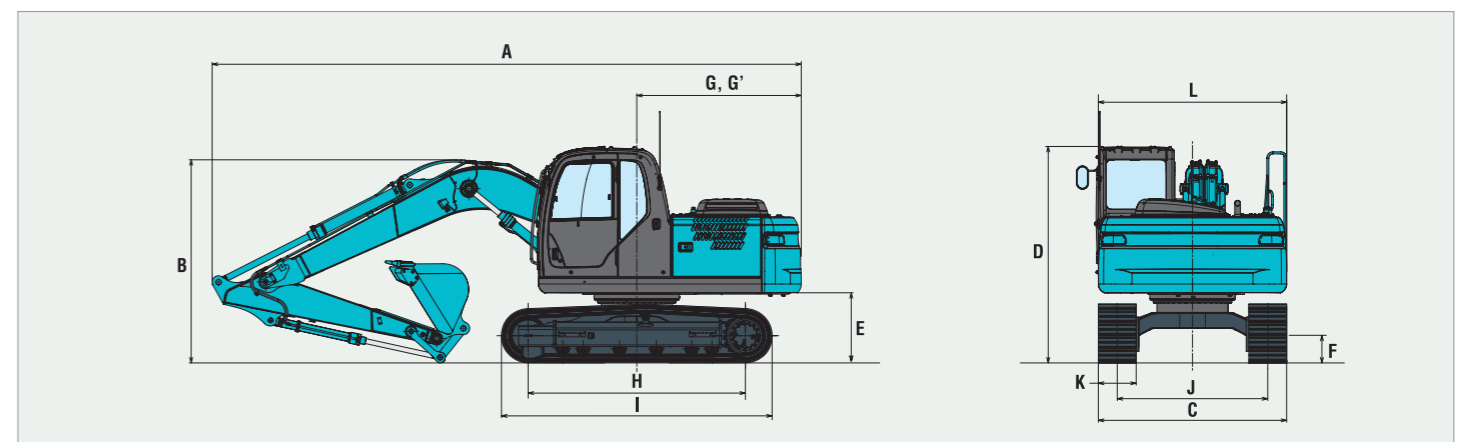

Operating Weight & Ground Pressure

In standard trim, with standard boom, 2.38 m arm, and 0.52 m³ ISO heaped bucket (SK130), 0.57 m³ ISO heaped bucket (SK140LC)

Shaped	Shoe width	mm	Triple grouser shoes (even height)		
			500	600	700
Overall width	mm		2,490	2,590	2,690
Ground pressure	kPa {kgf/cm ² }	SK130	40 {0.41}	34 {0.35}	30 {0.31}
		SK140LC	45 {0.46}	39 {0.40}	34 {0.35}
Operating weight	kg	SK130	12,800	13,200	13,200
		SK140LC	13,200	13,500	13,700

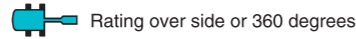
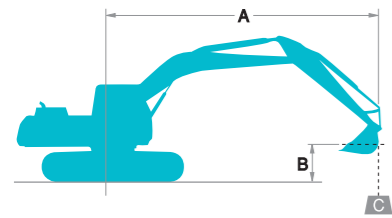

A - Reach from swing centerline to bucket hook
 B - Bucket hook height above/below ground
 C - Lifting capacities in kilograms
 • Max. discharge pressure: 37.8 MPa (385 kg/cm²)

SK130		Standard Arm: 2.38 m Bucket: 0.5 m ³ ISO heaped 410 kg Shoe: 500 mm										
		1.5 m		3.0 m		4.5 m		6.0 m		At max. reach		Radius
B	A											
6.0 m	kg									*1,230	*1,230	5.63 m
4.5 m	kg					*2,940	*2,940	*2,600	1,930	*1,150	*1,150	6.58 m
3.0 m	kg			*5,330	*5,330	*3,780	3,020	2,830	1,830	*1,180	*1,180	7.08 m
1.5 m	kg			*8,070	5,090	4,330	2,730	2,700	1,710	*1,300	1,210	7.23 m
G.L.	kg			*7,080	4,750	4,100	2,530	2,590	1,610	*1,550	1,220	7.06 m
-1.5 m	kg	*5,220	*5,220	*8,320	4,720	4,010	2,450	2,550	1,570	*2,040	1,380	6.53 m
-3.0 m	kg	*8,080	*8,080	*7,820	4,830	4,060	2,490			2,930	1,820	5.55 m
-4.5 m	kg			*5,170	5,150					*4,020	3,580	3.74 m

SK140LC		Standard Arm: 2.38 m Bucket: 0.5 m ³ ISO heaped 410 kg Shoe: 500 mm										
		1.5 m		3.0 m		4.5 m		6.0 m		At max. reach		Radius
B	A											
6.0 m	kg											5.63 m
4.5 m	kg							*2,940	*2,940	*2,600	1,960	6.58 m
3.0 m	kg			*5,330	*5,330	*3,780	3,070	3,090	1,860	*1,180	*1,180	7.08 m
1.5 m	kg			*8,070	5,170	4,770	2,780	2,960	1,740	*1,300	1,240	7.23 m
G.L.	kg			*7,080	4,830	4,530	2,570	2,850	1,640	*1,550	1,250	7.06 m
-1.5 m	kg	*5,220	*5,220	*8,910	4,800	4,440	2,500	2,800	1,600	*2,040	1,410	6.53 m
-3.0 m	kg	*8,080	*8,080	*7,820	4,910	4,490	2,540			3,220	1,860	5.55 m
-4.5 m	kg			*5,170	*5,170					*4,020	3,640	3.74 m

SK130		Standard Arm: 2.38 m Bucket: 0.52 m ³ ISO heaped 400 kg Shoe: 500 mm										
		1.5 m		3.0 m		4.5 m		6.0 m		At max. reach		Radius
B	A											
6.0 m	kg									*1,160	*1,160	5.75 m
4.5 m	kg							*2,590	1,950	*1,100	*1,100	6.68 m
3.0 m	kg			*5,080	*5,080	*3,690	3,050	2,850	1,860	*1,130	*1,130	7.17 m
1.5 m	kg			*7,860	5,140	4,350	2,750	2,710	1,730	*1,240	1,200	7.32 m
G.L.	kg			*7,360	4,750	4,100	2,530	2,600	1,620	*1,470	1,210	7.15 m
-1.5 m	kg	*5,150	*5,150	8,290	4,690	4,010	2,450	2,550	1,570	*1,930	1,350	6.63 m
-3.0 m	kg	*7,800	*7,800	*7,960	4,800	4,040	2,480			2,820	1,760	5.67 m
-4.5 m	kg			*5,510	5,090					*4,080	3,300	3.92 m

SK140LC		Standard Arm: 2.38 m Bucket: 0.52 m ³ ISO heaped 400 kg Shoe: 500 mm										
		1.5 m		3.0 m		4.5 m		6.0 m		At max. reach		Radius
B	A											
6.0 m	kg											5.75 m
4.5 m	kg							*2,590	1,990	*1,100	*1,100	6.68 m
3.0 m	kg			*5,080	*5,080	*3,690	3,100	3,120	1,890	*1,130	*1,130	7.17 m
1.5 m	kg			*7,860	5,220	*4,730	2,800	2,970	1,760	*1,240	1,220	7.32 m
G.L.	kg			*7,360	4,820	4,540	2,580	2,860	1,650	*1,470	1,230	7.15 m
-1.5 m	kg	*5,150	*5,150	*8,960	4,770	4,440	2,490	2,800	1,600	*1,930	1,370	6.63 m
-3.0 m	kg	*7,800	*7,800	*7,960	4,880	4,470	2,520			3,110	1,790	5.67 m
-4.5 m	kg			*5,510	5,170					*4,080	3,350	3.92 m

SK130		Short Arm: 2.09 m Bucket: 0.57 m ³ ISO heaped 420 kg Shoe: 500 mm										
		1.5 m		3.0 m		4.5 m		6.0 m		At max. reach		Radius
B	A											
6.0 m	kg					*2,950	*2,950			*1,810	*1,810	5.20 m
4.5 m	kg					*3,220	*3,220	*2,500	1,910	*1,730	*1,730	6.22 m
3.0 m	kg			*5,950	5,810	*4,050	2,990	2,830	1,830	1,790	1,460	6.75 m
1.5 m	kg			*6,900	5,000	4,310	2,720	2,700	1,720	1,990	1,340	6.91 m
G.L.	kg			*7,020	4,760	4,110	2,540	2,610	1,630	2,180	1,360	6.72 m
-1.5 m	kg	*5,890	*5,890	8,380	4,780	4,050	2,490	2,580	1,610	2,480	1,540	6.17 m
-3.0 m	kg	*9,310	*9,310	*7,470	4,920	4,120	2,550			3,380	2,120	5.11 m

SK140LC		SHORT Arm: 2.09 m Bucket: 0.57 m ³ ISO heaped 420 kg Shoe: 500 mm										
		1.5 m		3.0 m		4.5 m		6.0 m		At max. reach		Radius
B	A											
6.0 m	kg							*2,950	*2,950			5.20 m
4.5 m	kg							*3,220	*3,220	*2,500	1,940	6.22 m
3.0 m	kg			*5,950	5,890	*4,050	3,040	3,040	1,860	*1,790	1,490	6.75 m
1.5 m	kg			*6,900	5,070	4,740	2,760	2,960	1,750	*1,990	1,370	6.91 m
G.L.	kg			*7,020	4,840	4,540	2,580	2,870	1,660	2,390	1,380	6.72 m
-1.5 m	kg	*5,890	*5,890	*8,760	4,850	4,480	2,530	2,840	1,640	2,720	1,570	6.17 m
-3.0 m	kg	*9,310	*9,310	*7,470	5,000	4,550	2,600			3,720	2,150	5.11 m

SK130		Long Arm: 2.84 m Bucket: 0.38 m ³ ISO heaped 350 kg Shoe: 500 mm												
		1.5 m		3.0 m		4.5 m		6.0 m		7.5 m		At max. reach		Radius
B	A													
6.0 m	kg							*1,650	*1,650			*1,210	*1,210	6.20 m
4.5 m	kg							*2,570	1,970			*1,140	*1,140	7.07 m
3.0 m	kg					*3,370	3,090	2,860	1,860	*1,300	1,190	*1,160	*1,160	7.54 m
1.5 m	kg			*7,250	5,250	4,370	2,770	2,710	1,720	1,840	1,130	*1,250	1,080	7.68 m
G.L.	kg			*7,360	4,740	4,100	2,520	2,580	1,600	*1,540	1,080	*1,440	1,080	7.52 m
-1.5 m	kg	*4,490	*4,490	8,210	4,630	3,970	2,410	2,510	1,530			*1,820	1,190	7.03 m
-3.0 m	kg	*7,000	*7,000	*8,250	4,700	3,980	2,420	2,530	1,560			2,460	1,510	6.13 m
-4.5 m	kg			*6,220	4,940	*3,890	2,580					*3,790	2,520	4.57 m

SK140LC		Long Arm: 2.84 m Bucket: 0.38 m ³ ISO heaped 350 kg Shoe: 500 mm												
		1.5 m		3.0 m		4.5 m		6.0 m		7.5 m		At max. reach		Radius
B	A													
6.0 m	kg							*1,650	*1,650			*1,210	*1,210	6.20 m
4.5 m	kg							*2,570	2,000			*1,140	*1,140	7.07 m
3.0 m	kg					*3,370	3,140	*2,930	1,890	*1,300	1,210	*1,160	*1,160	7.54 m
1.5 m	kg			*7,250	5,330	*4,450	2,810	2,970	1,750	1,890	1,150	*1,250	1,100	7.68 m
G.L.	kg			*7,360	4,820	4,530	2,570	2,840	1,630	*1,540	1,110	*1,440	1,100	7.52 m
-1.5 m	kg	*4,490	*4,490	*8,770	4,710	4,400	2,450	2,770	1,560			*1,820	1,220	7.03 m
-3.0 m	kg	*7,000	*7,000	*8,250	4,780	4,410	2,460	2,790	1,590			*2,670	1,540	6.13 m
-4.5 m	kg			*6,220	5,020	*3,890	2,620					*3,790	2,560	4.57 m

Notes:

- Do not attempt to lift or hold any load that is greater than these lift capacities at their specified lift point radius and heights. Weight of all accessories must be deducted from the above lift capacities.
- Lift capacities are based on machine standing on level, firm, and uniform ground. User must make allowance for job conditions such as soft or uneven ground, out of level conditions, side loads, sudden stopping of loads, hazardous conditions, experience of personnel, etc.
- Bucket lift hook defined as lift point.
- The above lifting capacities are in compliance with ISO 10567. They do not exceed

- 87% of hydraulic lifting capacity or 75% of tipping load. Lifting capacities marked with an asterisk (*) are limited by hydraulic capacity rather than tipping load.
- Operator should be fully acquainted with the Operator's and Maintenance Instructions before operating this machine. Rules for safe operation of equipment should be adhered to at all times.
- Lift capacities apply to only machine as originally manufactured and normally equipped by KOBELCO CONSTRUCTION MACHINERY CO., LTD.