

KOBELCO

SK260_{LC}



We Save You Fuel
Achieving a Low-Carbon Society

Power Meets Efficiency



SK260_{LC}



17%
Higher fuel saving
means
"Efficiency"

Increase in
productivity
means
"Power"

Compared to H-mode on the SK260LC-8

To urban centers and mines around the world. Kobelco's all-out innovation brings you durable earth-friendly construction machinery suitable for any task and sites all over the planet. With greater fuel economy we deliver higher efficiency to any project. Kobelco SK260LC machines are also more durable than ever, able to withstand the rigors of the toughest job sites. It all adds up to new levels of value that are a step ahead of the times. While focusing on the global environment of the future, Kobelco offers next-generation productivity to meet the need for lower life cycle costs and exceed the expectations of customers globally.



* Piping for Nibbler&Breaker is fitted as standard

Evolution Continues, with Improved Fuel Efficiency.

In Pursuit of Improved Fuel Efficiency

Operation Mode

Fuel consumption is lower in H-mode/S-mode/ECO-mode in comparison with the previous model (Generation 8).

■ Compared to previous models



H	H-mode	17%
S	S-mode	14%
E	ECO-mode	23%

Values are approximate improvement rate.

Always and Forever. Yesterday, Today, and Tomorrow. Obsessed with Fuel Efficiency.

Over the past 10 years, Kobelco has achieved an average reduction of about 38% in fuel consumption. And we vow to continue to lead in fuel efficiency.

■ Compared to SK260LC-6 (2006)

E	ECO-mode (SK260LC-10)	38%
----------	-----------------------	-------	------------

AIS (Auto Idle Stop)

If the safety lock lever is lifted up, the engine will stop automatically. This eliminates wasteful idling during standby, saving fuel and reducing CO₂ emissions as well.

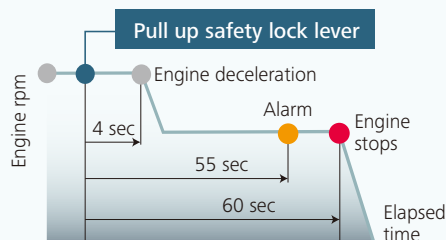



17%
Higher fuel saving
means
"Efficiency"

The new arm interflow system more efficiently controls hydraulic fluid flow, and significant reduction of in-line resistance and pressure loss boosts fuel efficiency by about 17%*.

The electronic-control common-rail engine features high-pressure fuel injection and multiple injection with improved precision.

* Compared to H-mode on the SK260LC-8

* Piping for Nibbler&Breaker is fitted as standard

Hydraulic System: Revolutionary Technology Saves Fuel

Arm Interflow System NEW

When lowering the boom, this system uses the downward force generated by the boom's weight to push fluid to the arm. This greatly reduces the need to apply power from outside the system.

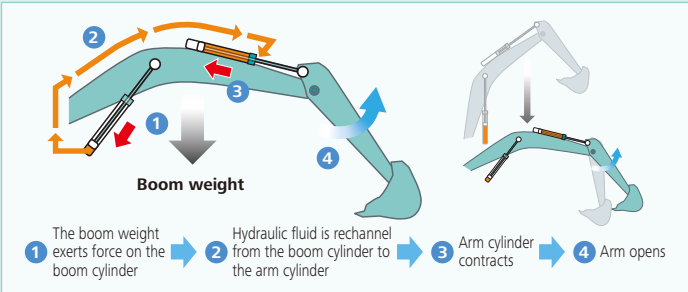

Hydraulic Circuit Reduces Energy Loss

We have made every effort to enhance fuel efficiency by minimizing hydraulic pressure resistance, improving the hydraulic line layout to control friction resistance loss and minimizing valve resistance.

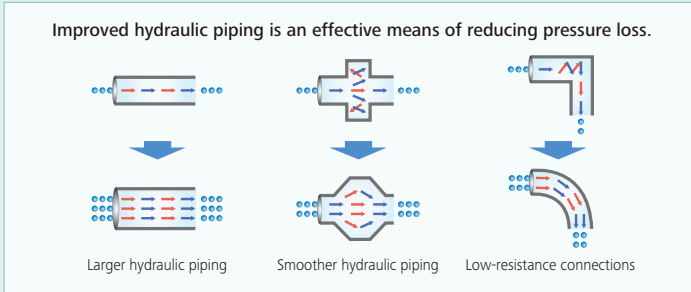

Pursuing Maximum Fuel Efficiency

Common Rail System

High-pressure injection atomizes the fuel, and more precise injection improves combustion efficiency. This also contributes to better fuel economy.

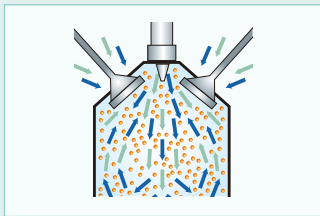

Piping for Nibbler & Breaker

Piping for Nibbler & Breaker is fitted as standard.



More Power and Higher Efficiency.

The highly efficient hydraulic system minimizes fuel consumption while maximizing power. With nimble movement and superior digging power, this excavator promises to improve your job productivity.

Improved Fuel Efficiency Contributes to High Performance

Superior Digging Performance

Powerful digging force delivers outstanding performance.

■ Max. Bucket Digging Force

Normal: **170kN**

With power boost: **187kN**

■ Max. Arm Crowding Force

Normal: **122kN**

With power boost: **134kN**

*Values are for STD arm(2.98m) and 1.00m³ bucket



* Piping for Nibbler&Breaker is fitted as standard

Get More Done Faster with Superior Operability

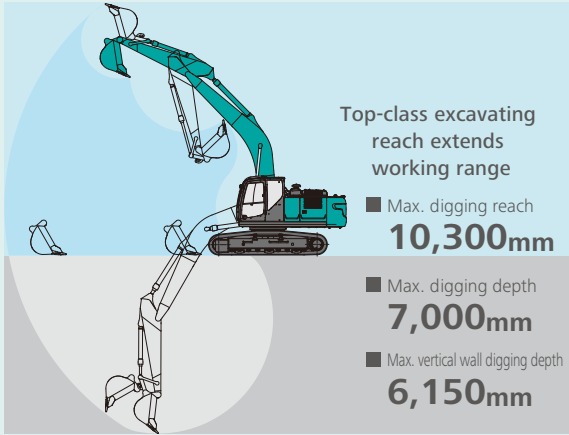

*Values are for STD arm(2.98m) and 1.00m³ bucket

Piping for Quick Hitch (optional)



A quick hitch hydraulic line, which speeds up attachment changes, is available as an option.

A Light Touch on the Lever NEW Means Smoother, Less Tiring Work



It takes 38%* less effort to work the operation lever, which reduces fatigue over long working hours or continued operations.

*compared to SK260LC-8

Top Class Traveling Force

Powerful traveling force and drawbar pulling force deliver plenty of speed when climbing slopes or negotiating bad roads, and the agility to change direction swiftly and smoothly.

■ Drawbar Pulling Force: **244kN**



Operator-friendly Features Include Controls that Are Easy to See, Easy to Use



Multi-Display in Color

Brilliant colors and graphic displays are easy to recognize on the LCD multi-display in the console. The display shows fuel consumption, maintenance intervals, and more.

- 1 Analog gauge provides an intuitive reading of fuel level and engine water temperature
- 2 Green indicator light shows low fuel consumption during operation
- 3 Fuel consumption/Switch indicator for rear camera images
- 4 Digging mode switch
- 5 Monitor display switch

One-Touch Attachment Mode Switch

A simple touch of a button, switches the hydraulic circuit and flow amount to match attachment changes. Icons help the operator to confirm the proper configuration at a glance.

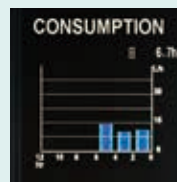

	REMAINING	EXPIRE DATE
ENGINE OIL	500	495
FUEL FILTER	500	495
HYD. FILTER	1000	995
HYD. OIL	5000	4995

Maintenance

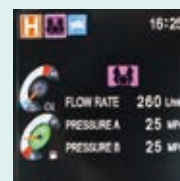
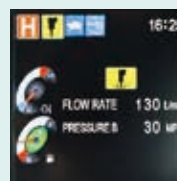

Increased Power, with Enhanced Durability to Maintain the Machine's Value

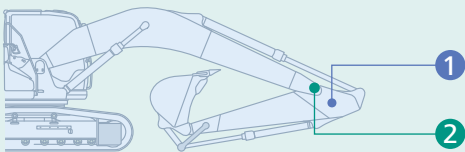

Built to Operate in Tough Working Environments

The attachment has been reinforced to handle a higher work volume, with greater power and excellent durability that can withstand demanding work conditions.

1 Enlarged Reinforcement of the Arm Foot

NEW
HD: Base plate thickness has been increased.

Current



New

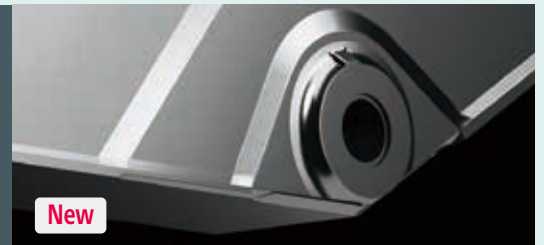

2 Modified Foot Boss Shape

NEW
The arm foot boss shape has been modified and improved to distribute stress, delivering more strength for tasks like digging next to a wall.

Current



New

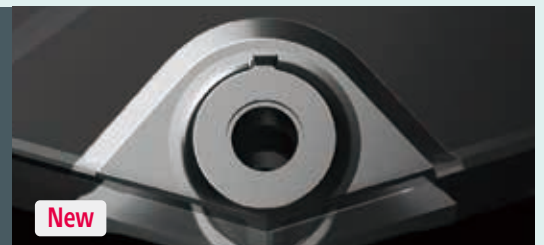

Increase in productivity means "Power"

Structural design increases strength, while eliminating hydraulic problems. Enhanced durability takes productivity to a new level.



* Piping for Nibbler&Breaker is fitted as standard

Improved Filtration System Reliability

Clean, contaminant-free fuel and hydraulic fluid are essential to stable performance. The improved filtration systems reduce the risk of mechanical trouble and enhance longevity and durability.

Hydraulic Fluid Filter NEW

Recognized as the best in the industry, our Premium-fine filter separates out even the smallest particles. New cover prevents contamination when changing filters.



Hydraulic Fluid Filter Clog Detector NEW

Hydraulic tank pressure sensor monitors the pressure difference between the return line and tank inside pressure to determine the degree of clogging. If the difference exceeds a predetermined level, a warning appears on the multi-display, so any contamination can be trapped by the filter and replaced before it reaches the hydraulic fluid in the tank.

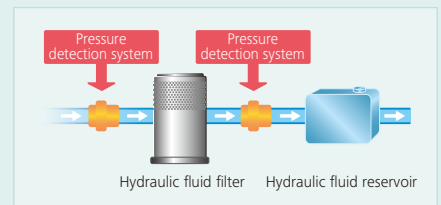

Metal Mesh Cover NEW Air Cleaner

Metal mesh cover ensures strength and durability.



Fuel Filter

The pre-filter with built-in water separator has 1.6 times more filter area compared to the previous models and with a new final stage maintenance free fuel filter to maximize filtering performance.

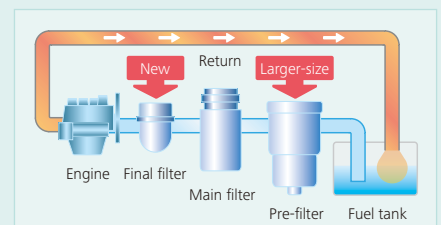

Comfortable Cab Is Now Safer than Ever.

A work environment that is quieter and more comfortable. A cab that puts the operator first is key to improved safety.



Comfort

Super-Airtight Cab



The high level of air-tightness keeps dust out of the cab.

Quiet Inside

The high level of air-tightness ensures a quiet, comfortable cabin interior.

Low Vibration

Coil springs absorb small vibrations, and high suspension mounts filled with silicone oil reduce heavy vibration. The long stroke achieved by this system provides excellent protection from vibration.

Twice the stroke of a conventional mount

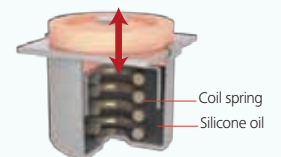

Broad View Liberates the Operator

The front window features one large piece of glass without a center pillar on the right side for a wide, unobstructed view.

Air Conditioner Louvers behind the Seat NEW

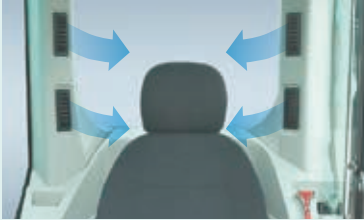

The large air-conditioner has louvers on the back pillars that blow from behind and to the right and left of the operator's seat. They can be adjusted to put a direct flow of cool/warm air on the operator, which means a more comfortable operating environment.

More Comfortable Seat Means Higher Productivity

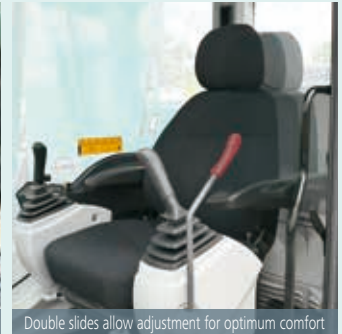

Large Cab Is Easy to Get in and Out of

The expanded cab provides plenty of room for a large door, more headroom and smoother entry and exit.

Interior Equipment Adds to Comfort and Convenience



Safety

ROPS Cab*

ROPS (Roll-Over-Protective Structure)-compliant cab clears ISO standards (ISO-12117-2: 2008) and ensures greater safety for the operator should the machine tip over.

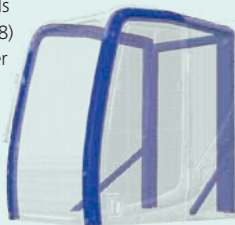

Expanded Field of View for Greater Safety

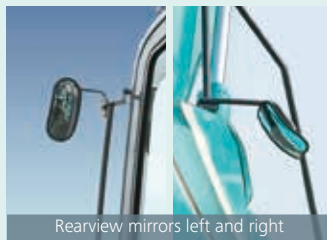

Greater safety assured by rearview mirrors on left and right.



Rear view shows the area directly behind the cab.

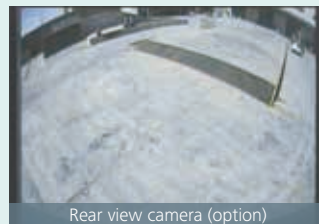

A rear view camera is installed as option to simplify checking for safety behind the machine. The picture appears on the color monitor.

*If the operating mass exceeds MAX. MASS (maximum operating mass) described on ROPS CERTIFICATION with the special attachment or others installed, it will cause insufficient protective function, resulting in serious accidents or death should the machine tip/roll over.

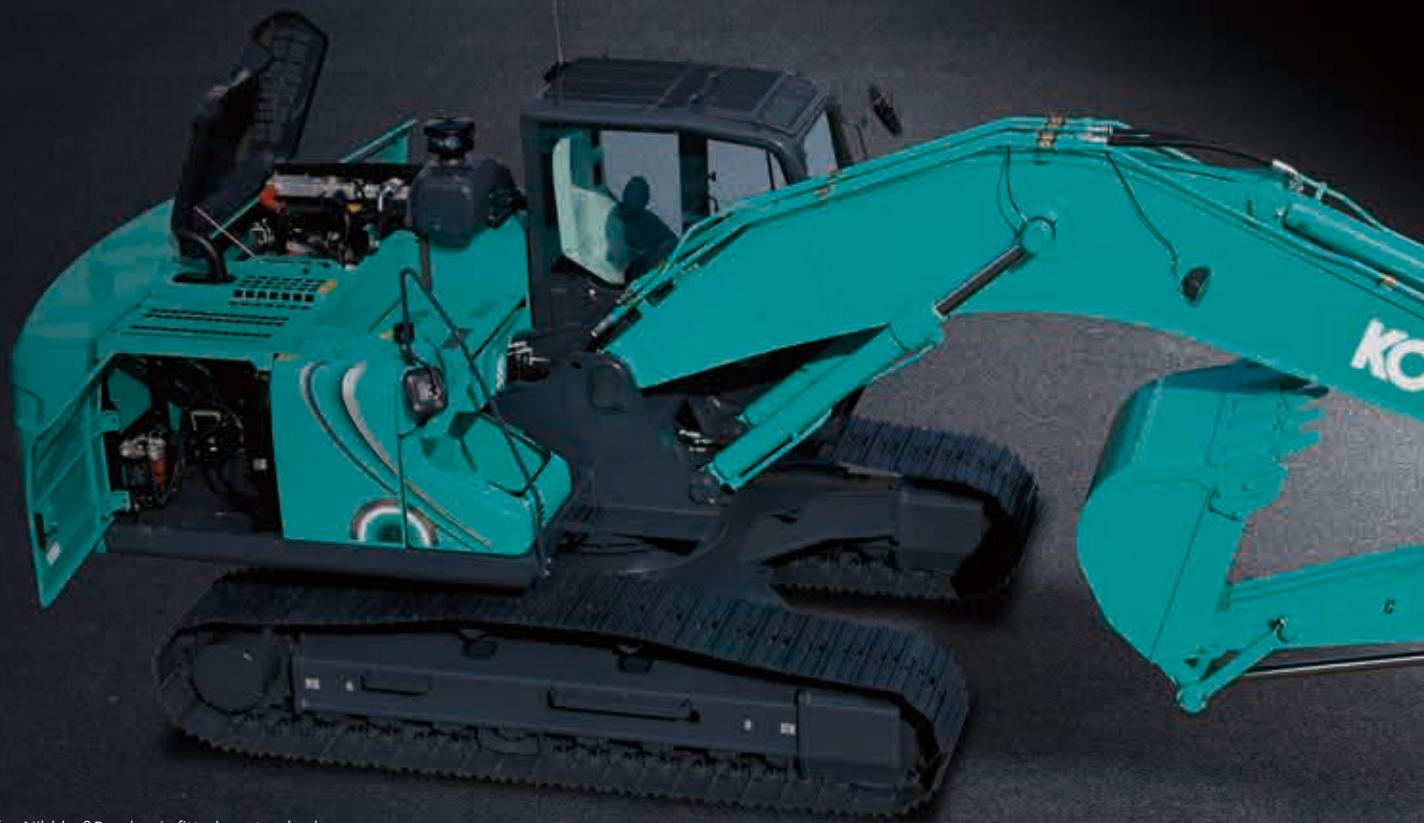

* Piping for Nibbler&Breaker is fitted as standard

Easy, On-the-Spot Maintenance NEW

There is ample space in the engine compartment for a mechanic to do maintenance work inside. The distance between steps is lower so entry and exit is easier. And the mechanic can work in comfort, without contortions or unnatural body positions. Finally, the hood is lighter and easier to raise and lower.



Generous space for maintenance work



Step/Hand rail



Double-element air cleaner

Maintenance Work, Daily Checks, Etc., Can Be Done from Ground Level

The layout allows for easy access from the ground for many daily checks and regular maintenance tasks.



Fuel filter with built-in water-separator



Fuel filter

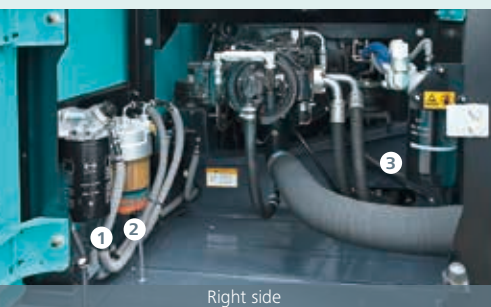

Right side



Left side

- ① Fuel filter
- ② Fuel filter with built-in water-separator
- ③ Engine oil filter

Simple layout for easy access to radiator and cooling system elements.

Efficient Maintenance Keeps the Machine in Peak Operating Condition.



Machine Information Display Function

Examples of displaying maintenance information

- Displays only the maintenance information that's needed, when it's needed
- Self-diagnostic function provides early-warning detection and display of electrical system malfunctions
- Service-diagnostic function makes it easier to check the status of the machine
- Record function of previous breakdowns including irregular and transient malfunction

More Efficient Maintenance Inside the Cab

Internal and external air conditioner filters can be easily removed without tools for cleaning.



Easy Cleaning



Special crawler frame design for easy mud removal cleaning.

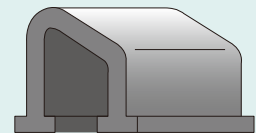

Long-life hydraulic oil:
5,000
hours

Long-Interval Maintenance

Long-life hydraulic oil reduces cost and labor.

Replacement cycle:
1,000
hours

Highly Durable Premium-fine Filter

The high-capacity hydraulic oil filter incorporates glass fiber with superior cleaning power and durability.



Detachable two-piece floor mat with handles for easy removal. A floor drain is located under floor mat.



Engine oil pan equipped with drain valve.

Excavator Remote Monitoring System

Remote Monitoring System is a satellite-based system for receiving machine information. Manage your machines anywhere in the world using the Internet. Location, workload and diagnostic data aid business operations.

Direct Access to Operational Status

Location Data

Accurate location data can be obtained even from sites where communications are difficult.

Operating Hours

A comparison of operating times of machines at multiple locations shows which locations are busier and more profitable. Operating hours on site can be accurately recorded, for running time calculations needed for rental machines, etc.

Fuel Consumption Data

Data on fuel consumption and idling times can be used to indicate improvements in fuel consumption.

Graph of Work Content

The graph shows how working hours are divided among different operating categories, including digging, idling, traveling, and optional operations (N&B).

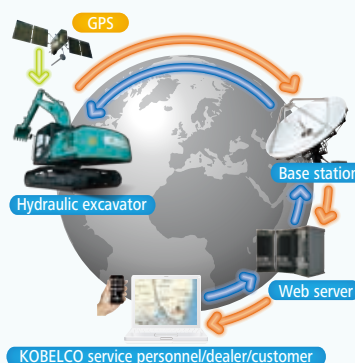

Maintenance Data and Warning Alerts

Machine Maintenance Data

Provides maintenance status of separate machines operating at multiple sites. Maintenance data is also relayed to KOBELCO service personnel, for more efficient planning of periodic servicing.

Security System

Engine Start Alarm

Sends a notification if the engine is started outside of pre-defined hours.

Area Alarm

Sends a notification if the machine leaves a pre-defined area.

Note: Remote monitoring system is not applicable in some area due to country regulation of the communication lines or availability of infrastructure.



Engine

Model	HINO J05E-TH
Type	Direct injection, water-cooled, 4-cycle diesel engine with turbocharger, intercooler
No. of cylinders	4
Bore and stroke	112 mm x 130 mm
Displacement	5.123 L
Rated power output	132 kW/2,100 min ⁻¹ (ISO 9249: with fan)
	137kW/2,100 min ⁻¹ (ISO 14396: without fan)
Max. torque	644 N•m/1,600 min ⁻¹ (ISO 9249: with fan)
	654 N•m/1,600 min ⁻¹ (ISO 14396: without fan)



Hydraulic System

Pump	
Type	Two variable displacement axial piston pumps + one gear pump
Max. discharge flow	2 x 245 L/min, 1 x 21 L/min
Relief valve setting	
Boom, arm and bucket	34.3 MPa {350 kgf/cm ² }
Power Boost	37.8 MPa {385 kgf/cm ² }
Travel circuit	34.3 MPa {350 kgf/cm ² }
Swing circuit	28.4 MPa {290 kgf/cm ² }
Control circuit	5.0 MPa {50 kgf/cm ² }
Pilot control pump	Gear type
Main control valve	8-spool
Oil cooler	Air cooled type



Swing System

Swing motor	Axial piston motor
Brake	Hydraulic; locking automatically when the swing control lever is in neutral position
Parking brake	Wet multiple plate
Swing speed	10.8 min ⁻¹ {rpm}
Tail swing radius	3,100 mm
Min. front swing radius	3,910 mm



Attachments

Backhoe bucket and arm combination

Use			HD bucket	Standard bucket	Full HD bucket	
Bucket capacity	ISO heaped	m ³	1.00	1.20	1.10	1.30
	ISO Struck	m ³	0.76	0.84	0.81	0.90
Opening width	With side cutters	mm	1,310	1,440	1,250	1,420
	Without side cutters	mm	1,190	1,340	1,250	1,420
No. of teeth			5	5	5	5
Bucket weight		kg	890	840	1,100	1,190
Combinations	2.50m short arm		○	◎	◎	△
	2.98m standard arm		◎	○	○	△

◎ Standard combination ○ General operation △ Light operation



Travel System

Travel motors	Variable displacement piston pump
Travel brakes	Hydraulic
Parking brakes	Wet multiple plate
Travel shoes	51 each side
Travel speed	6.1/3.8 km/h
Drawbar pulling force	244 kN (ISO 7464)
Gradeability	70 % {35°}
Ground clearance	460 mm



Cab & Control

Cab	
All-weather, sound-suppressed steel cab mounted on the high suspension mounts filled with silicone oil and equipped with a heavy, insulated floor mat.	
Control	
Two hand levers and two foot pedals for travel	
Two hand levers for excavating and swing	
Electric rotary-type engine throttle	



Boom, Arm & Bucket

Boom cylinders	135 mm x 1,235 mm
Arm cylinder	145 mm x 1,635 mm
Bucket cylinder	125 mm x 1,200 mm



Refilling Capacities & Lubrications

Fuel tank	403 L
Cooling system	21 L
Engine oil	20.5 L
Travel reduction gear	2 x 4.5 L
Swing reduction gear	5 L
Hydraulic oil tank	165 L tank oil level
	331 L hydraulic system



Working Ranges

Unit: m

Boom	Arm	6.02m	
		Short 2.5 m	Standard 2.98 m
Range			
a- Max. digging reach		9.89	10.30
b- Max. digging reach at ground level		9.72	10.14
c- Max. digging depth		6.52	7.00
d- Max. digging height		9.65	9.79
e- Max. dumping clearance		6.72	6.88
f- Min. dumping clearance		3.03	2.55
g- Max. vertical wall digging depth		5.82	6.15
h- Min. swing radius		3.91	3.91
i- Horizontal digging stroke at ground level		4.20	5.26
j- Digging depth for 2.4 m (8') flat bottom		6.32	6.82
Bucket capacity ISO heaped m ³		1.20	1.00

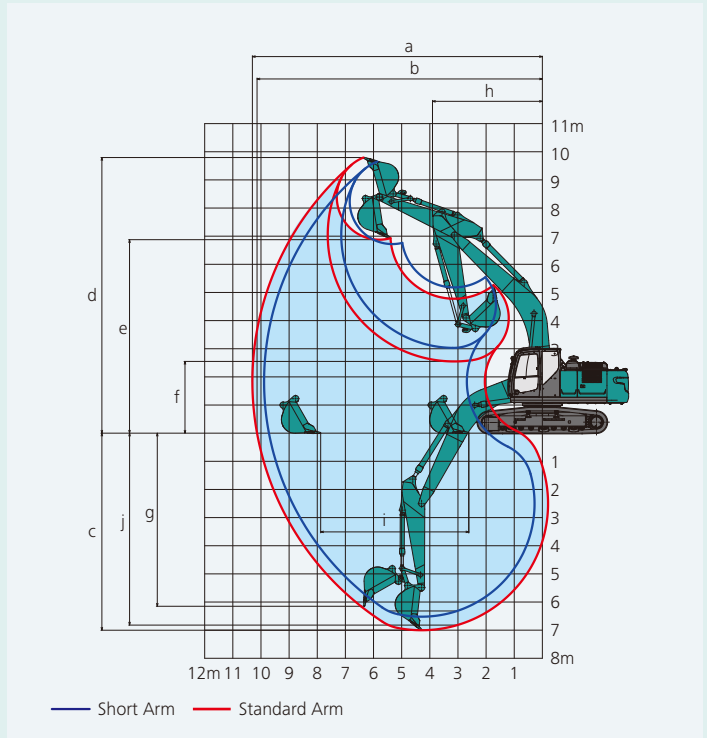

Digging Force (ISO 6015)

Unit: kN

Arm length	Short 2.50 m	Standard 2.98 m
Bucket digging force	170 187*	170 187*
Arm crowding force	142 156*	122 134*

*Power Boost engaged.



Dimensions

Unit: mm

Arm length	Short 2.50 m	Standard 2.98 m
A Overall length	10,270	10,210
B Overall height (to top of boom)	3,340	3,180
C Overall width of crawler	3,190	
D Overall height (to top of cab)	3,040	
E Ground clearance of rear end*	1,090	
F Ground clearance*	460	

G Tail swing radius	3,100
G' Distance from center of swing to rear end	3,070
H Tumbler distance	3,850
I Overall length of crawler	4,640
J Track gauge	2,590
K Shoe width	600
L Overall width of upperstructure	2,980

*Without including height of shoe lug

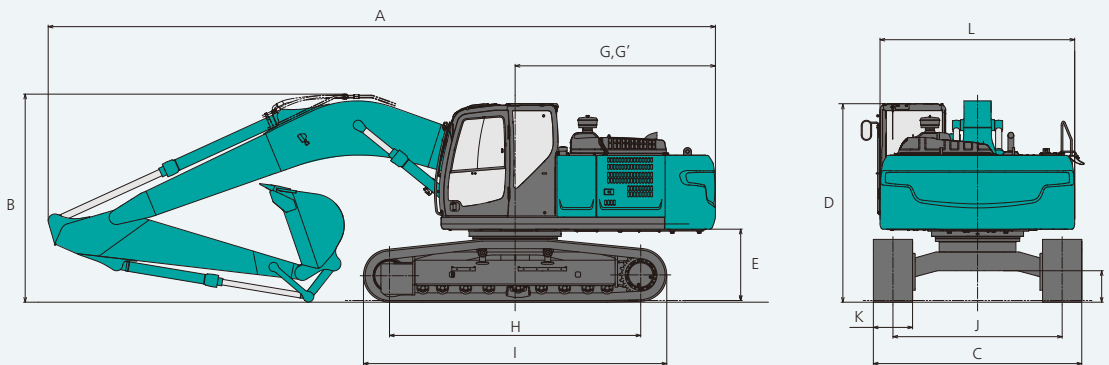

Operating Weight & Ground Pressure

In standard trim, with standard boom, 2.98 m arm, and 1.00 m³ ISO heaped bucket

Shaped		Triple grouser shoes (even height)		
		600	700	800
Shoe width	mm	600	700	800
Overall width	mm	3,190	3,290	3,390
Ground pressure	kPa	51	44	39
Operating weight	kg	25,800	26,000	26,300

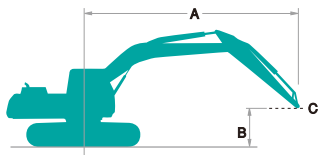

Rating over front



Rating over side or 360 degrees

A: Reach from swing centerline to arm top
 B: Arm top height above/below ground
 C: Lift point
 Bucket: Without bucket
 Relief valve setting: 34.3 MPa (350 kgf/cm²)

SK260LC		Short Arm: 2.50 m Bucket: Without Shoe: 600 mm Counterweight: 5,580 kg										
B	A	3.0 m		4.5 m		6.0 m		7.5 m		At Max. Reach		Radius
7.5 m	kg											
6.0 m	kg					*5,700	*5,700			*5,760	*5,760	6.14 m
4.5 m	kg			*7,560	*7,560	*6,310	*6,310	*5,810	4,750	*5,800	4,310	7.94 m
3.0 m	kg			*9,690	9,650	*7,260	6,380	*6,210	4,590	5,930	3,920	8.29 m
1.5 m	kg			*11,410	9,000	*8,190	6,040	*6,680	4,420	5,750	3,780	8.36 m
G. L.	kg			*12,100	8,740	*8,790	5,830	6,640	4,310	5,890	3,850	8.16 m
-1.5 m	kg	*10,360	*10,360	*11,990	8,730	*8,920	5,770	6,620	4,300	6,440	4,190	7.66 m
-3.0 m	kg	*15,390	*15,390	*11,150	8,880	*8,360	5,860			*7,100	5,010	6.79 m
-4.5 m	kg	*12,410	*12,410	*9,080	*9,080					*7,290	7,170	5.38 m

SK260LC		Standard Arm: 2.98 m Bucket: Without Shoe: 600 mm Counterweight: 5,580 kg												
B	A	1.5 m		3.0 m		4.5 m		6.0 m		7.5 m		At Max. Reach		Radius
7.5 m	kg											*4,470	*4,470	6.70 m
6.0 m	kg							*5,220	*5,220	*5,280	5,000	*4,230	*4,230	7.73 m
4.5 m	kg							*5,930	*5,930	*5,500	4,900	*4,190	4,070	8.37 m
3.0 m	kg					*9,070	*9,070	*6,950	6,570	*5,980	4,720	*4,310	3,740	8.71 m
1.5 m	kg					*11,020	9,320	*7,970	6,220	*6,530	4,540	*4,590	3,610	8.78 m
G. L.	kg					*12,050	8,950	*8,720	5,970	6,720	4,400	*5,090	3,660	8.58 m
-1.5 m	kg	*6,690	*6,690	*10,500	*10,500	*12,220	8,860	*9,010	5,870	6,660	4,350	*5,970	3,930	8.11 m
-3.0 m	kg	*11,820	*11,820	*16,590	*16,590	*11,660	8,950	*8,710	5,900			*6,840	4,570	7.30 m
-4.5 m	kg			*14,010	*14,010	*10,070	9,220	*7,220	6,140			*7,190	6,120	6.01 m

- Notes:**
- Do not attempt to lift or hold any load that is greater than these lift capacities at their specified lift point radius and heights. Weight of all accessories must be deducted from the above lift capacities.
 - Lift capacities are based on machine standing on level, firm, and uniform ground. User must make allowance for job conditions such as soft or uneven ground, out of level conditions, side loads, sudden stopping of loads, hazardous conditions, experience of personnel, etc.
 - Arm top defined as lift point.
 - The above lift capacities are in compliance with ISO 10567. They do not exceed 87% of hydraulic lift capacity or 75% of tipping load. Lift capacities marked with an asterisk (*) are limited by hydraulic capacity rather than tipping load.
 - Operator should be fully acquainted with the Operator's and Maintenance Instructions before operating this machine. Rules for safe operation of equipment should be adhered to at all times.
 - Lift capacities apply to only machine as originally manufactured and normally equipped by KOBELCO CONSTRUCTION MACHINERY CO., LTD.
 - The above figures indicate machine capacity, but in practice the machine should not be used for lifting loads.

STANDARD EQUIPMENT

ENGINE

- Engine, HINO J05E-TH, diesel engine with turbocharger and intercooler
- Automatic engine deceleration
- Auto Idle Stop (AIS)
- Batteries (2 x 12V - 96Ah)
- Starting motor (24V - 5 kW), 50 amp alternator
- Automatic engine shut-down
- Engine oil pan drain cock
- Double element air cleaner

CONTROL

- Working mode selector (H-mode, S-mode and ECO-mode)
- Power Boost

SWING SYSTEM & TRAVEL SYSTEM

- Swing rebound prevention system
- Straight propel system
- Two-speed travel with automatic shift down
- Sealed & lubricated track links
- Grease-type track adjusters
- Automatic swing brake

HYDRAULIC

- N & B piping
- Arm regeneration system
- Auto warm up system
- Aluminum hydraulic oil cooler
- Arm interflow system
- Hydraulic fluid filter clog detector

MIRRORS & LIGHTS

- Two rear view mirrors
- Two boom lights
- One storage box lights

CAB & CONTROL

- Two control levers, pilot-operated
- Horn, electric
- Cab light (interior)
- Luggage tray
- Large cup holder
- Detachable two-piece floor mat
- Headrest
- Handrails
- Intermittent windshield wiper with double-spray washer
- Skylight
- Tinted safety glass
- Pull-up type front window and removable lower front window
- Easy-to-read multi-display color monitor
- Automatic air conditioner
- Emergency escape hammer
- Excavator Remote Monitoring System
- Suspension seat
- Two speakers
- 12V outlet (DC/DC)

OPTIONAL EQUIPMENT

- Additional reinforced track guide
- Two cab lights
- Air suspension seat
- Various optional buckets
- Travel alarm
- Lower under cover
- Refilling pump
- Rear view camera
- Front guard
- Various optional arms
- 700 mm shoes
- 800 mm shoes
- Yellow rotating warning light
- N & B piping less
- Rotatory N & B piping
- Boom & arm safety valve and quick hitch piping (N & B piping only)

Note: Standard and optional equipment may vary. Consult your KOBELCO dealer for specifics.

Note: This catalog may contain attachments and optional equipment that are not available in your area. And it may contain photographs of machines with specifications that differ from those of machines sold in your areas. Please consult your nearest KOBELCO distributor for those items you require. Due to our policy of continuous product improvements all designs and specifications are subject to change without advance notice. Copyright by KOBELCO CONSTRUCTION MACHINERY CO., LTD. No part of this catalog may be reproduced in any manner without notice.

KOBELCO CONSTRUCTION MACHINERY CO., LTD.

5-15, Kitashinagawa 5-chome, Shinagawa-ku, Tokyo 141-8626 JAPAN
 Tel: +81 (0) 3-5789-2146 Fax: +81 (0) 3-5789-2135
 www.kobelcocm-global.com

Inquiries To: