

KOBELCO

HYDRAULIC CRAWLER CRANE
CKE1800

Model: CKE1800-1F

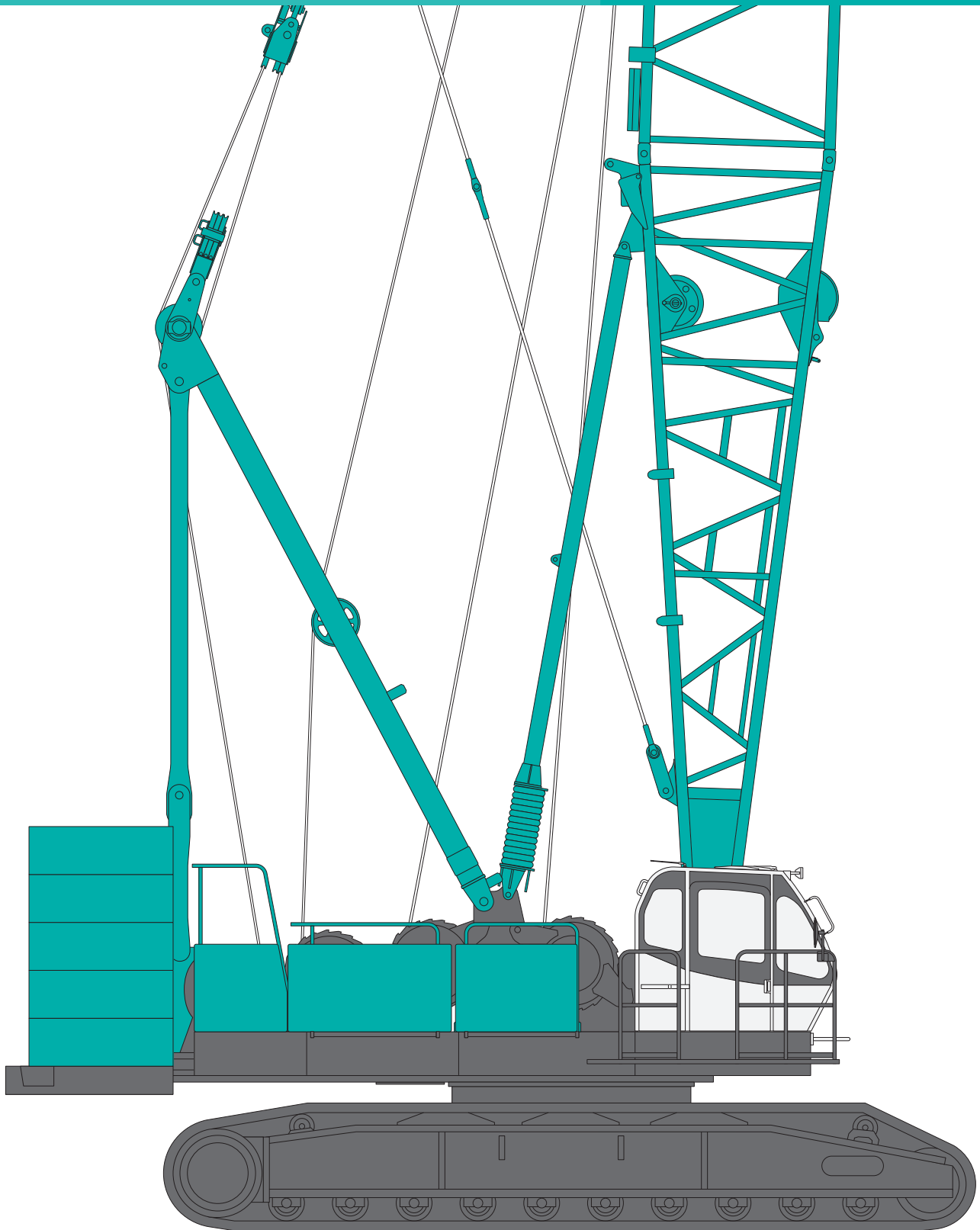

Max. Lifting Capacity: 180 ton x 3.75 m
Max. Crane Boom Length: 85.3 m
Max. Long Boom Length: 85.3 m
Max. Fixed Jib Combination: 73.2 m + 30.5 m
Max. Luffing Jib Combination: 54.9 m + 51.8 m

CONFIGURATION

Crane Boom

Max. Lifting Capacity:
160 metric ton x 4.4 m
Max. Boom Length:
85.3 m



Long Boom

Max. Lifting Capacity:
40.1 metric ton x 12.0 m
Max. Boom Length:
85.3 m



Heavy Duty Crane Boom

Max. Lifting Capacity:
180 metric ton x 3.75 m
Max. Boom Length:
42.7 m



Luffing Boom

Max. Lifting Capacity:
110 metric ton x 5.2 m
Max. Boom Length:
54.9 m

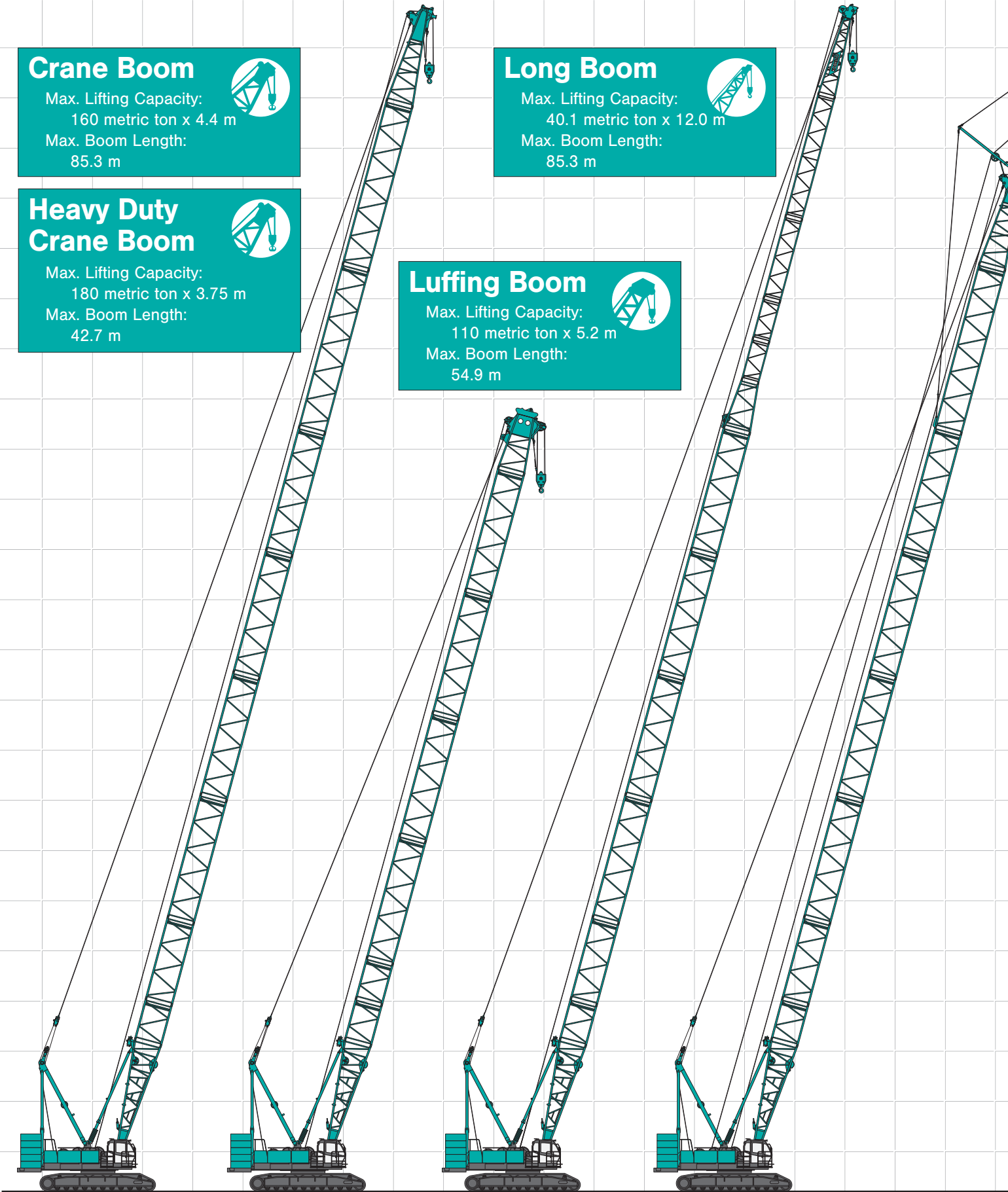

Fixed Jib

Max. Lifting Capacity:
26.8 metric ton x 15.2 m
Max. Combination:
73.2 m + 30.5 m



Luffing Jib

Max. Lifting Capacity:
48.6 metric ton x 9.14m
Max. Combination:
54.9 m + 51.8 m



Luffing Boom with Luffing Jib

Max. Lifting Capacity:
71.5 metric ton x 9.0 m



CONTENTS

Configuration	1
Specifications	3
General Dimensions	5
Boom and Jib Arrangements	
Crane Boom Arrangements.....	7
Fixed Jib Arrangements.....	8
Long Boom Arrangements.....	8
Luffing Boom Arrangements for Luffing	9
Luffing Boom Arrangements for Crane.....	9
Luffing Jib Arrangements.....	10
Working Ranges and Lifting Capacities	
Crane Boom Working Ranges.....	12
Crane Boom Lifting Capacity.....	13
Luffing Boom Working Ranges.....	14
Luffing Boom Lifting Capacity.....	15
Long Boom Working Ranges.....	16
Long Boom Lifting Capacity.....	17
Fixed Jib Working Ranges.....	18
Fixed Jib Lifting capacities	19
Luffing Jib Working Ranges.....	21
Luffing Jib Lifting capacities	23
Luffing Boom Lifting Capacities with Luffing Jib.....	30
Parts and Attachments.....	31
Transportation Plan	35

SPECIFICATIONS



Power Plant

Model: Hino diesel engine P11C-UN
Type: Water-cooled, direct fuel injection, with turbocharger
Complies with NRMM (Europe) Tier III and USA EPA Tier III
Displacement: 10.52 L
Rated power: 247 kW/ 2,000 min⁻¹ {rpm} (ISO)
Max. Torque: 1,300 N-m/1,500 min⁻¹
Cooling System: Liquid, re-circulating bypass
Starter: 24 V / 6.0 kW
Radiator: Corrugated type core, thermostatically controlled
Air cleaner: Dry type with replaceable paper element
Throttle: Electric throttle control, twist grip type
Fuel filter: Replaceable paper element.
Batteries: Two 12V, 170 Ah/20HR capacity batteries, series connected.
Fuel tank capacity: 400 L



Hydraulic System

Four variable displacement piston pumps are driven by heavy duty pump drive. Two of variable displacement pumps are used in the main hook hoist circuit, auxiliary hook hoist circuit, third hoist circuit and each propel circuit. One of the other two pumps is used in the boom hoist circuit, and the other is used in the swing circuit.

Control: Full-flow hydraulic control system for infinitely variable pressure to front and rear drums, boom hoist brakes and clutches. Controls respond instantly to the touch, delivering smooth function operation.

Cooling: Oil-to-air heat exchanger (plate-fin type)

Filtration: Full-flow and bypass type with replaceable element

Electrical system: All wiring corded for easy servicing, individual fused branch circuits.

Max. relief valve pressure:

Load hoist, boom hoist and propel system:

31.9 MPa {325 kgf/cm²}

Swing system: 27.5 MPa {280 kgf/cm²}

Control system: 7.0 MPa {71.3 kgf/cm²}

Oil Quantity (at the reference level): 540 L



Boom Hoisting System

Powered by a hydraulic motor through a planetary reducer.

Brake: A spring-set, hydraulically released multiple-disc brake is mounted on the boom hoist motor and operated through a counter-balance valve.

Drum Lock: External ratchet for locking drum

Drum: Double drum, grooved for 22 mm dia. wire rope.

Line Speed: Double line on first drum layer

Hoisting/Lowering: 54 m/min

Diameter of wire ropes

Boom guy line: 30 mm

Boom hoist reeving: 16 parts of 22 mm dia. high strength wire rope

Boom backstops: Telescopic type with spring bumper
Required for all boom lengths



Load Hoisting System

Front and rear drums for load hoist powered by a hydraulic variable plunger motors, driven through planetary reducers.

Negative Brake: A spring-set, hydraulically released multiple disc brake is mounted on the hoist motor and operated through a counter-balance valve. (Positive free fall brake is optional item.)

Drum Lock: External ratchet for locking drum

Drums:

Front Drum:

617.4 mm P.C.D. x 833.7 mm Lg. wide drum, grooved for 25.4 mm wire rope. Rope capacity is 430 m working length and 510 m storage length.

Rear Drum:

617.1 mm P.C.D. x 833.7 mm Lg. wide drum, grooved for 25.4 mm wire rope. Rope capacity is 335 m working length and 510 m storage length.

Note: Rope lengths listed above denote drum capacity and may differ from actual rope lengths supplied when machinery is shipped.

Line Speed: Single line on the first drum layer

Hoisting/Lowering: 100 m/min

Line Pull (Single-line):

Rated Line Pull: 132 kN {13.5 tf}



Swing System

Swing unit is powered by hydraulic motor driving spur gears through planetary reducers (2 sets), the swing system provides 360° rotation.

Swing parking brakes: A spring-set, hydraulically released multiple-disc brake is mounted on swing motor.

Swing circle: Single-row ball bearing with an integral internally cut swing gear.

Swing lock: Manually, four position lock for transportation

Swing Speed: 2.6 min⁻¹ {rpm}



Upper Structure

Torsion-free precision machined upper frame. All components are located clearly and service friendly. Engine with low noise level. Complies with European Noise Regulations.

Counterweight: 60.0 ton



Cab & Control

Totally enclosed, full vision cab with safety glass, fully adjustable, high backed seat with a head-rest and armrests, and intermittent wiper and window washer (skylight and front window).

Cab fittings:

Air conditioner, convenient compartment (for tool), cup holder, ashtray, cigarette lighter, sun visor, roof blind, tinted glass, floor mat, foot-rest, shoe tray

Controls:

Four adjustable levers for front drum, rear drum, boom drum and swing controls, and boom hoist pedal.



Lower Structure

Steel-welded carbody with axles. Crawler assemblies are designed with quick disconnect feature for individual removal as a unit from axles. Crawler belt tension is maintained by hydraulic jack force on the track-adjusting bearing block.

Carbody weight: 20.0 ton

Crawler drive: Independent hydraulic propel drive is built into each crawler side frame. Each drive consists of a hydraulic motor propelling a driving tumbler through a planetary gear box. Hydraulic motor and gear box are built into the crawler side frame within the shoe width.

Crawler brakes: Spring-set, hydraulically released parking brakes are built into each propel drive.

Steering mechanism: A hydraulic propel system provides both skid steering (driving one track only) and counter-rotating steering (driving each track in opposite directions).

Track rollers: Sealed track rollers for maintenance-free operation.

Shoes (flat): 64 shoes, 1,070 mm wide each crawler

Max. travel speed: 1.1/0.7 km/h

Max. gradeability: 30%



Weight

Including upper and lower machine, 60.0 ton counterweight and 20.0 ton carbody weight, basic boom (or basic boom + basic jib), hook, and other accessories.

Specification	Weight	Ground pressure
Crane boom	Approx. 164 ton,	103 kPa {1.06 kgf/cm ² }
Luffing jib	Approx. 171 ton,	95 kPa {0.97 kgf/cm ² }



Attachment

Boom and Jib:

Welded lattice construction using tubular, high-tensile steel chords with pin connections between sections.

Boom and Jib length

	Min. Length (Min. Combination)	Max. Length (Max. Combination)
Crane Boom	15.2 m	85.3 m
Luffing Boom	15.2 m	54.9 m
Long Boom	61.0 m	85.3 m
Fixed Jib	24.4 m + 12.2 m	73.2 m + 30.5 m
Luffing Jib	21.3 m + 21.3 m	54.9 m + 51.8 m

Main Specifications (Model: CKE1800-1F)

Heavy Duty Crane Boom	
Max. Lifting Capacity	180 t/3.75 m
Max. Length	42.7 m
Crane Boom	
Max. Lifting Capacity	160 t/4.4 m
Max. Length	85.3 m
Luffing Boom	
Max. Lifting Capacity	110 t/5.2 m
Max. Length	54.9 m
Long Boom	
Max. Lifting Capacity	40.1 t/12.0 m
Max. Length	85.3 m
Fixed Jib	
Max. Lifting Capacity	26.8 t/15.2 m
Max. Length	30.5 m
Max. Combination	73.2 m + 30.5 m
Luffing Jib	
Max. Lifting Capacity	48.6 t/9.14 m
Jib Length	21.3 m to 51.8 m
Max. Combination	54.9 m + 51.8 m
Luffing Angle	60° to 88°
Working Speed	
Swing Speed	2.6 min ⁻¹ {rpm}
Travel Speed	1.1/0.7 km/h

Power Plant	
Model	Hino P11C-UN
Engine Output	247 kW/2,000 min ⁻¹ {rpm}
Fuel Tank Capacity	400 L
Main & Aux. Winch	
Max. Line Speed	100 m/min (1st layer)
Rated Line Pull	132 kN {13.5 tf}
Wire Rope Diameter	25.4 mm
Wire Rope Length	430 m (Main) 335 m (Aux.)
Brake Type	Spring set hydraulically released (Negative)
Free Fall Brake	Wet-type multiple disc brake (Optional)
Hydraulic System	
Pumps	4 variable displacement
Max. Pressure	31.9 MPa {325 kgf/cm ² }
Oil Quantity (at the reference level)	540 L
Self Erection Device	
	Standard
Weight	
Operating Weight*	Approx. 164 t
Ground Pressure*	103 kPa {1.06 kgf/cm ² }
Counterweight	60.0 t (Upper), 20.0 t (Lower)
Transportation Weight**	Approx. 44.0 t

* Including upper and lower machine, 60.0 ton counterweight, 20.0 ton carbody weight, basic boom, hook, and other accessories.

** Base machine with boom base, trans-lifter, main and aux. winches (non-freefall) including wire rope, self removal device.

Units are SI units. { } indicates conventional units.

GENERAL DIMENSIONS

Crane Boom

(Unit: mm)

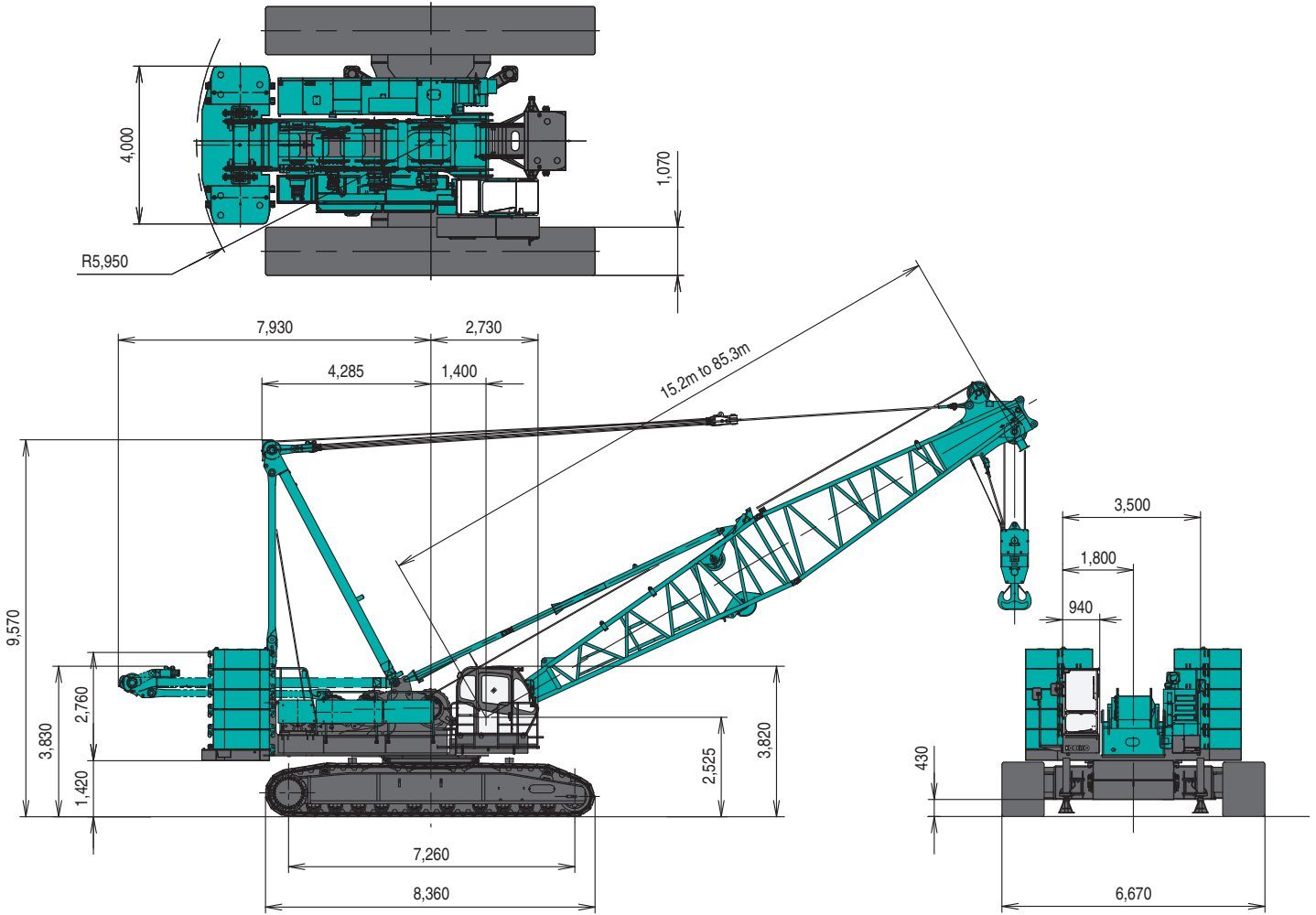

Limit of Hook Lifting

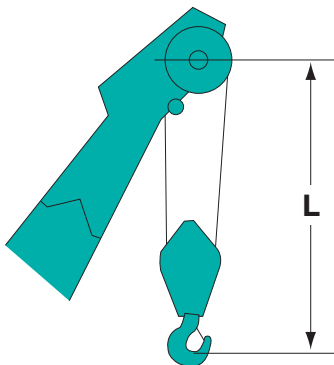

Hook	L
180 t/160 t hook	5.2 m
110 t hook	5.1 m
70 t hook	4.9 m
35 t hook	4.7 m

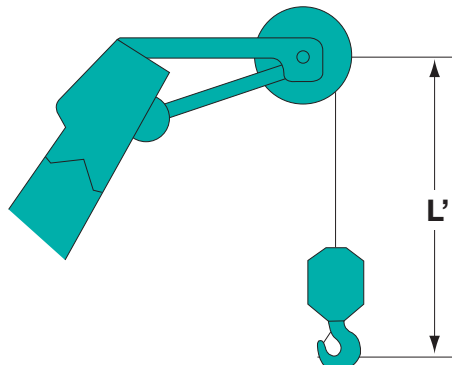

Hook	L'
13.5 t Ball hook	3.5 m

Luffing Jib

(Unit: mm)

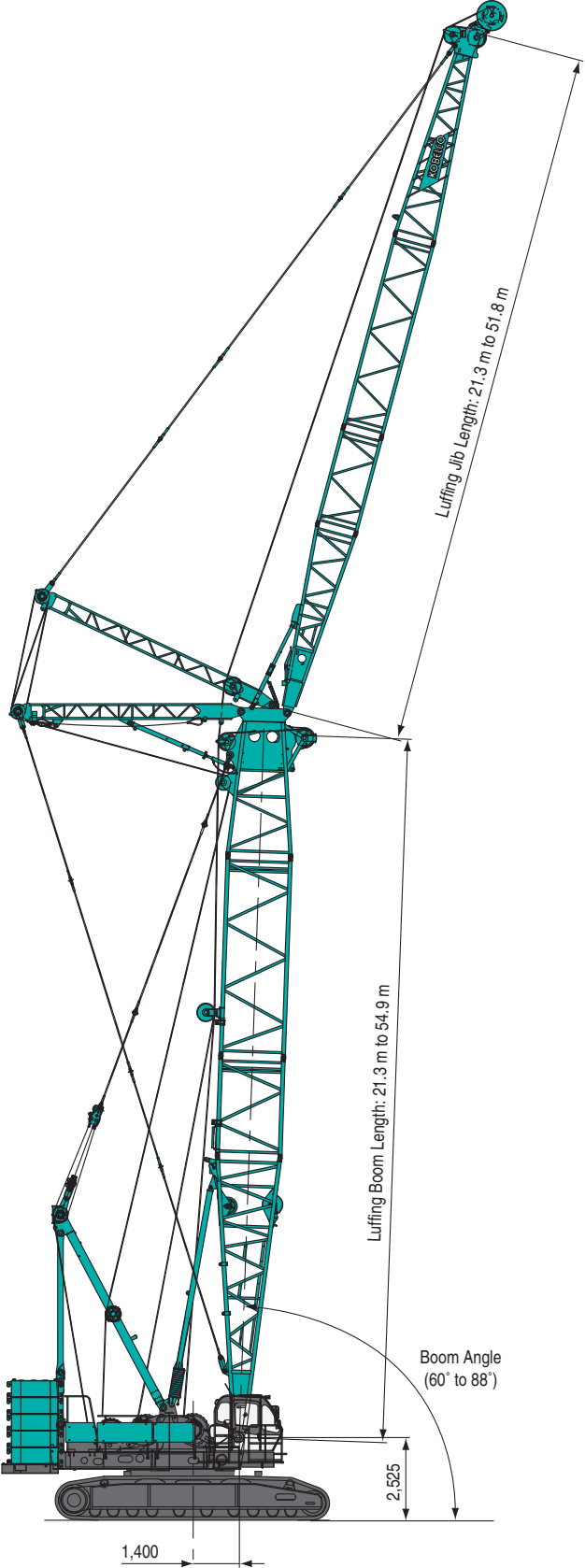

BOOM AND JIB ARRANGEMENTS

Crane Boom Arrangements

Boom length m (ft)	Boom arrangement
12.2 (40)	For Heavy Duty Crane Boom
15.2 (50)	
18.3 (60)	
21.3 (70)	
24.4 (80)	
27.4 (90)	
30.5 (100)	
33.5 (110)	
36.6 (120)	
39.6 (130)	
42.7 (140)	
45.7 (150)	
48.8 (160)	
51.8 (170)	
54.9 (180)	

Boom length m (ft)	Boom arrangement
57.9 (190)	
61.0 (200)	
64.0 (210)	
67.1 (220)	
70.1 (230)	
73.2 (240)	
76.2 (250)	
79.3 (260)	
82.3 (270)	
85.3 (280)	

Symbol	Boom Length	Remarks
	8.5 m	Boom Base
	3.7 m	Heavy Duty Crane Boom Tip
	6.7 m	Boom Tip
	3.0 m	Insert Boom
	6.1 m	Insert Boom
	9.1 m	Insert Boom
	12.2 m	Insert Boom

↘ mark shows the guy line installing position when the fixed jib is used.

※ Indicates the most flexible combination of insert booms, which can be modified to form all shorter boom arrangements.

Fixed Jib Arrangements

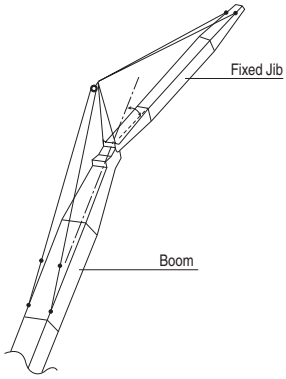

Crane boom length	Jib length m (ft)	Jib arrangement
24.4 m to 73.2 m	12.2 (40)	
	18.3 (60)	
	24.4 (80)	
	30.5 (100)	

Symbol	Jib Length	Remarks
	4.6 m	Jib Base
	4.6 m	Jib Tip
	3.0 m	Insert Jib
	6.1 m	Insert Jib

Long Boom Arrangements

Boom length m (ft)	Long Boom arrangement
61.0 (200)	
64.0 (210)	
67.1 (220)	
70.1 (230)	
73.2 (240)	
76.2 (250)	
79.3 (260)	
82.3 (270)	
85.3 (280)	

Symbol	Long Boom Length	Remarks
	8.5 m	Boom Base
	6.4 m	Luffing Jib Tip
	3.0 m	Insert Boom
	6.1 m	Insert Boom
	9.1 m	Insert Boom
	3.6 m	Taper Insert Boom
	3.0 m	Luffing Insert Jib
	6.1 m	Luffing Insert Jib
	9.1 m	Luffing Insert Jib

※Indicates the most flexible combination of insert long booms, which can be modified to form all shorter long boom arrangements.

Luffing Boom Arrangements for Luffing

Boom length m (ft)	Boom arrangement	Boom length m (ft)	Boom arrangement
21.3 (70)	※ 	39.6 (130)	※
24.4 (80)	※ 	42.7 (140)	※
27.4 (90)	※ 	45.7 (150)	※
30.5 (100)	※ 	48.8 (160)	※
33.5 (110)	※ 	51.8 (170)	※
36.6 (120)	※ 	54.9 (180)	※

Symbol	Luffing Boom Length	Remarks
	8.5 m	Boom Base
	3.7 m	Luffing Boom Tip
	3.0 m	Insert Boom
	6.1 m	Insert Boom
	9.1 m	Insert Boom

※Indicates the most flexible combination of insert luffing booms, which can be modified to form all shorter luffing boom arrangements.

Luffing Boom Arrangements for Crane





Boom length m (ft)	Boom arrangement	Boom length m (ft)	Boom arrangement
15.2 (50)		36.6 (120)	※
18.3 (60)	※ 	39.6 (130)	※
21.3 (70)	※ 	42.7 (140)	※
24.4 (80)	※ 	45.7 (150)	※
27.4 (90)	※ 	48.8 (160)	※
30.5 (100)	※ 	51.8 (170)	※
33.5 (110)	※ 	54.9 (180)	※



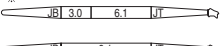
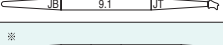
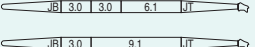
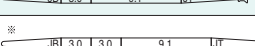
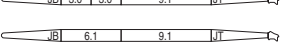
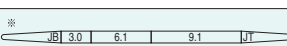
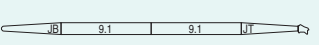
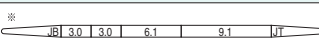
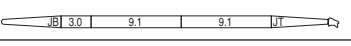
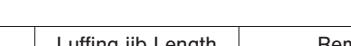

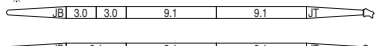
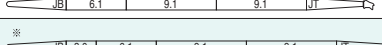
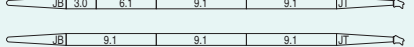
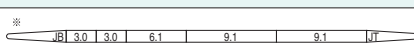
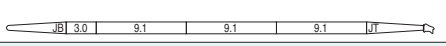
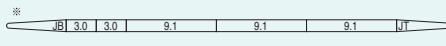
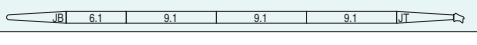
Symbol	Luffing Boom Length	Remarks
	8.5 m	Boom Base
	3.7 m	Luffing Boom Tip
	3.0 m	Insert Boom
	6.1 m	Insert Boom
	9.1 m	Insert Boom

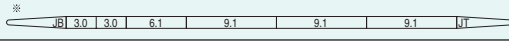
※Indicates the most flexible combination of insert luffing booms, which can be modified to form all shorter luffing boom arrangements.

Luffing Jib Arrangements

Jib length m (ft)	Jib arrangement
21.3 (70)	※  
24.4 (80)	※  
27.4 (90)	※  
30.5 (100)	※  
33.5 (110)	※  

Jib length m (ft)	Jib arrangement
36.6 (120)	※  
39.6 (130)	※  
42.7 (140)	※  
45.7 (150)	※  
48.8 (160)	※ 
51.8 (170)	※ 

Symbol	Luffing jib Length	Remarks
	5.8 m	Luffing Jib Base
	6.4 m	Luffing Jib Tip
	3.0 m	Luffing Insert Jib
	6.1 m	Luffing Insert Jib
	9.1 m	Luffing Insert Jib

※Indicates the most flexible combination of insert luffing jibs, which can be modified to form all shorter luffing jib arrangements.

Luffing Boom and Jib Combinations.

		Jib Length (m)										
		21.3	24.4	27.4	30.5	33.5	36.6	39.6	42.7	45.7	48.8	51.8
Boom Length (m)	21.3	○	○	○	○	○	○	○	○	○	○	○
	24.4	○	○	○	○	○	○	○	○	○	○	○
	27.4	○	○	○	○	○	○	○	○	○	○	○
	30.5	○	○	○	○	○	○	○	○	○	○	○
	33.5	○	○	○	○	○	○	○	○	○	○	○
	36.6	○	○	○	○	○	○	○	○	○	○	○
	39.6	○	○	○	○	○	○	○	○	○	○	○
	42.7	○	○	○	○	○	○	○	○	○	○	○
	45.7	○	○	○	○	○	○	○	○	○	○	○
	48.8	○	○	○	○	○	○	○	○	○	○	○
	51.8	○	○	○	○	○	○	○	○	○	○	○
	54.9	○	○	○	○	○	○	○	○	○	○	○

○ : Combinations which is allowed



Hook Blocks

A range of hook blocks can be specified, each with a safety latch.

Hooks	Weight (kg)	No. of sheaves	No. of lines and max. rated loads (tons)					
			1	2	3	4	5	6
180/160-ton	2,800	8	—	26.8	40.1	53.5	66.9	80.3
110-ton	1,800	4	—	26.8	40.1	53.5	66.9	80.3
70-ton	1,200	3	—	26.8	40.1	53.5	66.9	70.0
35-ton	900	1	—	26.8	35.0	—	—	—
13.5-ton ball hook	460	0	13.5	—	—	—	—	—









Hooks	Weight (kg)	No. of sheaves	No. of lines and max. rated loads (tons)					
			7	8	9	10	12	14
180/160-ton	2,800	8	93.7	107.0	120.4	133.8	160.0	180.0
110-ton	1,800	4	93.7	107.0	110.0	—	—	—
70-ton	1,200	3	—	—	—	—	—	—
35-ton	900	1	—	—	—	—	—	—
13.5-ton ball hook	460	0	—	—	—	—	—	—



Main Hoist Drum Rated Loads in Metric Tons

No. of Parts of Line	1	2	3	4	5	6
Max. Loads (ton)	13.5	26.8	40.1	53.5	66.9	80.3
No. of Parts of Line	7	8	9	10	12	14
Max. Loads (ton)	93.7	107.0	120.4	133.8	160.0	180.0

Symbols for Attachments:

								
Crane Boom	Auxiliary Sheave for Crane Boom	Luffing Boom	Aux. Sheave for Luffing Boom	Long Boom	Aux. Sheave for Long Boom	Fixed Jib	Luffing Jib	Luffing Boom with Luffing Jib

WORKING RANGES AND LIFTING CAPACITIES

Crane Boom Working Ranges

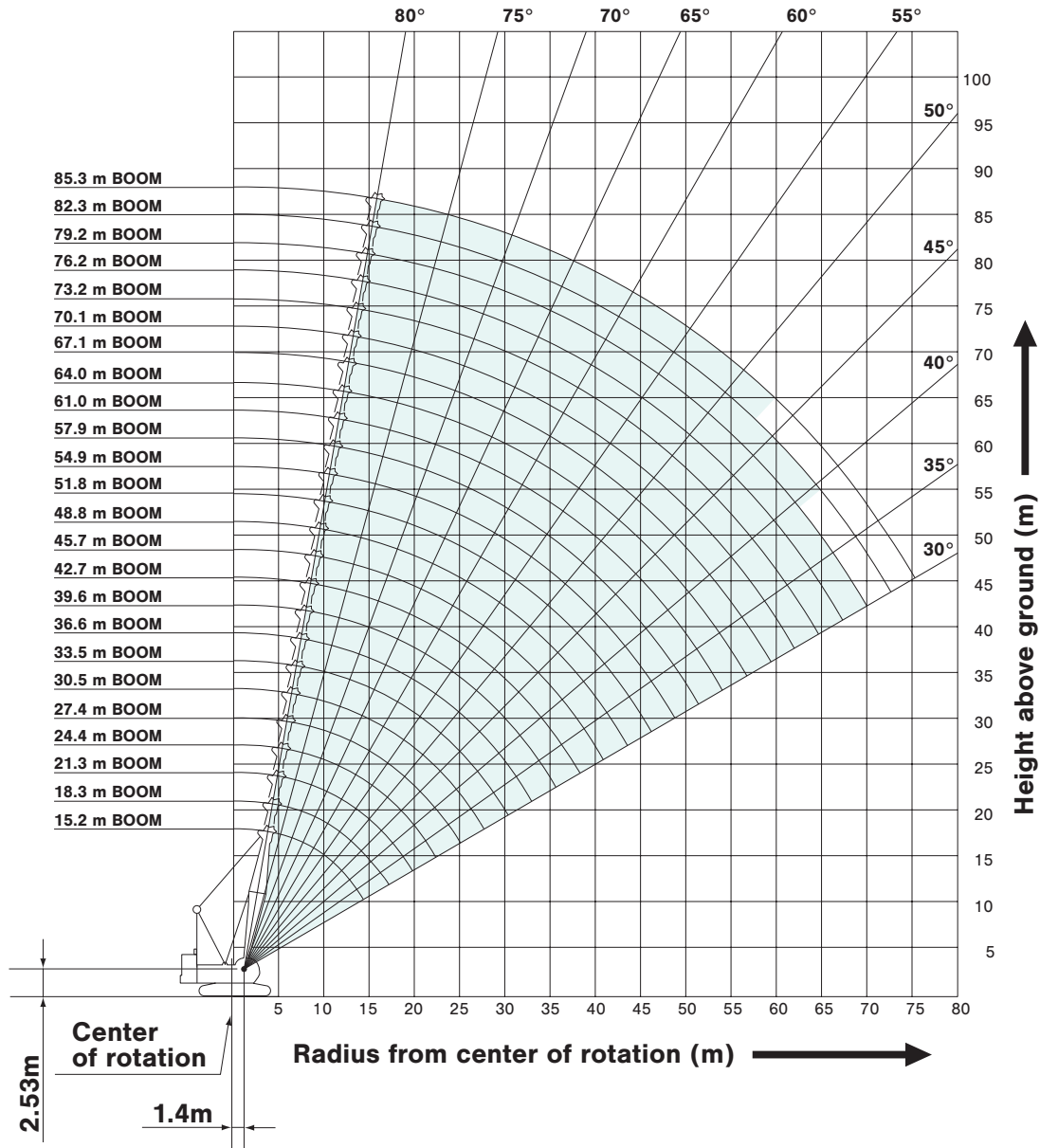

NOTES:

1. Ratings according to EN13000.
2. Ratings in metric tons for 360° working area.
3. Operating radius is the horizontal distance from center of rotation to a vertical line through the center of gravity of the load.
4. Deduct weight of hook block(s), slings and all other load handling accessories from main boom or auxiliary sheave ratings shown.
5. Ratings shown are based on freely suspended loads and make no allowance for such factors as wind effect on lifted load, ground conditions out-of-level, operating speeds or any other condition that could be detrimental to the safe operation of this equipment. Operator, therefore, has the responsibility to judge the existing conditions and reduce lifted loads and operating speeds accordingly.
6. Ratings are for operation on a firm and level surface, up to 1% gradient.
7. At radii and boom lengths where no ratings are shown on chart, operation is not intended nor approved.
8. Boom inserts and guy lines must be arranged as shown in the "Operator's Manual".
9. Boom hoist reeving is 16 part line.
10. Gantry must be in raised position for all conditions.
11. Boom backstops are required for all boom lengths.
12. The boom should be erected over the front of crawlers, not laterally.
13. Ratings shown in are determined by the strength of the boom or other structural component.
14. Instruction in the "Operator's Manual" must be strictly observed when operating the machine.
15. Crane boom ratings: Deduct weight of hook block(s), slings, and all other load handling accessories from crane boom ratings shown.
16. Auxiliary sheave ratings: Deduct 0.6 ton (weight of auxiliary sheave frame), weight of hook block(s), slings and all other load handling accessories from crane boom ratings shown, but should not exceed 26.8 tons. Crane boom lengths for auxiliary sheave mounting are 15.2 m to 82.3 m.
17. Crane boom ratings with auxiliary sheave: Deduct 0.6 ton, weight of hook block(s), slings and all other load handling accessories from crane boom ratings shown. Minimum ratings is 1.6 tons.
18. Heavy duty crane boom ratings: Deduct weight of hook block(s), slings and all other load handling accessories from crane boom ratings shown.



Crane Boom Lifting Capacity

Unit: metric ton

Counterweight: 60.0 t
Carbody Weight: 20.0 t

Working radius (m)	Boom length (m)															Boom length (m)	Working radius (m)	
		12.2*	15.2	18.3	21.3	24.4	27.4	30.5	33.5	36.6	39.6	42.7	45.7	48.8	51.8			
3.0	3.75m / 180.0																	3.0
4.0	171.5	4.4m / 160.0	4.9m / 144.2															4.0
5.0	140.5	141.6	141.6	5.4m / 131.4	5.9m / 121.3													5.0
6.0	119.1	119.3	119.3	119.3	119.3	6.4m / 112.0	6.9m / 103.9											6.0
7.0	102.0	102.7	102.7	102.7	102.7	102.7	102.5	7.4m / 97.1	7.9m / 90.6									7.0
8.0	88.1	89.5	89.5	89.5	89.5	89.5	89.5	89.5	89.5	8.4m / 80.3	8.9m / 76.8							8.0
9.0	76.8	79.0	79.0	79.0	79.0	79.0	79.0	79.0	79.0	78.4	76.3	9.4m / 70.6						9.0
10.0	67.7	71.5	71.5	71.5	71.5	71.5	71.5	71.5	71.5	70.2	68.4	66.6	10.0m / 65.4	10.5m / 60.7				10.0
12.0	51.4	58.8	58.7	58.6	58.5	58.4	58.3	58.2	58.2	57.8	56.5	55.1	54.0	52.8	12.0			12.0
14.0	12.4m / 50.0	47.2	47.7	47.6	47.4	47.3	47.2	47.0	47.0	46.9	46.7	46.5	46.0	45.0	14.0			14.0
16.0		14.8m / 41.9	40.2	40.1	39.9	39.8	39.6	39.4	39.4	39.3	39.1	38.9	38.8	38.6	16.0			16.0
18.0			17.5m / 35.9	34.4	34.2	34.1	34.0	33.7	33.7	33.6	33.3	33.2	33.1	32.9	18.0			18.0
20.0				30.1	29.8	29.6	29.5	29.3	29.2	29.1	28.9	28.7	28.6	28.4	20.0			20.0
22.0				20.1m / 29.9	26.5	26.3	26.2	25.9	25.8	25.7	25.5	25.3	25.3	25.0	22.0			22.0
24.0					22.7m / 25.4	23.6	23.4	23.2	23.0	22.9	22.7	22.5	22.4	22.2	24.0			24.0
26.0						25.4m / 22.0	21.1	20.9	20.7	20.6	20.4	20.2	20.1	19.9	26.0			26.0
28.0							28.0m / 19.2	19.0	18.8	18.7	18.5	18.3	18.2	18.0	28.0			28.0
30.0								17.4	17.2	17.1	16.9	16.7	16.6	16.4	30.0			30.0
32.0								30.7m / 16.9	15.8	15.7	15.4	15.2	15.1	14.9	32.0			32.0
34.0									33.3m / 15.0	14.4	14.2	14.0	13.9	13.6	34.0			34.0
36.0										35.9m / 13.4	13.1	13.0	12.8	12.6	36.0			36.0
38.0											12.2	12.1	11.8	11.7	38.0			38.0
40.0											38.6m / 12.0	11.1	11.0	10.7	40.0			40.0
42.0												41.2m / 10.7	10.3	10.0	42.0			42.0
44.0													43.8m / 9.7	9.4	44.0			44.0
46.0														8.7	46.0			46.0
48.0														46.5m / 8.6	48.0			48.0
Reeves	14	12	12	10	10	9	8	8	7	6	6	6	5	5	Reeves			

* Values of 12.2 m boom length are lifting capacities for heavy duty crane boom.

Working radius (m)	Boom length (m)															Boom length (m)	Working radius (m)	
		54.9	57.9	61.0	64.0	67.1	70.1	73.2	76.2	79.2	82.3	85.3						
10.0	11.0m / 56.4	11.5m / 52.4																10.0
12.0	51.5	50.5	12.0m / 48.3	12.5m / 44.7	13.0m / 41.2	13.5m / 38.0												12.0
14.0	43.9	43.2	42.3	41.5	40.1	37.5	14.0m / 34.5	14.5m / 31.8	15.0m / 29.0	15.5m / 25.9							14.0	
16.0	38.1	37.5	36.7	36.1	35.3	34.8	32.2	30.1	27.9	25.3	16.1m / 21.0						16.0	
18.0	32.7	32.7	32.3	31.8	31.1	30.7	29.8	27.8	25.9	22.9	19.0						18.0	
20.0	28.3	28.2	28.0	27.9	27.7	27.3	26.7	25.8	23.9	20.9	17.2						20.0	
22.0	24.9	24.8	24.6	24.5	24.4	24.2	24.0	23.6	22.0	19.1	15.6						22.0	
24.0	22.1	22.0	21.9	21.7	21.6	21.4	21.4	21.3	20.3	17.5	14.2						24.0	
26.0	19.7	19.7	19.4	19.4	19.2	19.0	19.0	18.9	18.7	16.0	13.0						26.0	
28.0	17.8	17.7	17.5	17.5	17.3	17.1	17.0	17.0	16.8	14.7	11.8						28.0	
30.0	16.2	16.1	15.9	15.8	15.6	15.5	15.4	15.3	15.2	13.5	10.8						30.0	
32.0	14.7	14.6	14.4	14.3	14.2	14.0	13.9	13.8	13.7	12.4	9.9						32.0	
34.0	13.5	13.4	13.2	13.1	12.9	12.8	12.7	12.6	12.4	11.4	9.0						34.0	
36.0	12.4	12.3	12.1	12.0	11.9	11.7	11.6	11.5	11.3	10.4	8.2						36.0	
38.0	11.4	11.3	11.2	11.1	10.9	10.8	10.7	10.5	10.3	9.6	7.4						38.0	
40.0	10.6	10.4	10.2	10.2	10.0	9.8	9.7	9.6	9.4	8.7	6.7						40.0	
42.0	9.9	9.7	9.5	9.4	9.3	9.1	9.0	8.9	8.7	8.0	6.0						42.0	
44.0	9.2	9.0	8.9	8.8	8.5	8.4	8.3	8.2	8.0	7.3	5.4						44.0	
46.0	8.5	8.4	8.2	8.1	7.9	7.7	7.6	7.5	7.4	6.6	4.8						46.0	
48.0	8.0	7.9	7.6	7.6	7.4	7.2	7.1	7.0	6.8	6.0	4.2						48.0	
50.0	49.1m / 7.7	7.4	7.1	7.0	6.9	6.7	6.6	6.5	6.3	5.4	3.7						50.0	
52.0		51.8m / 6.9	6.7	6.6	6.4	6.2	6.0	5.9	5.8	4.8	3.2						52.0	
54.0			6.2	6.2	6.0	5.7	5.6	5.5	5.3	4.3	2.7						54.0	
56.0			54.4m / 6.1	5.8	5.5	5.3	5.2	5.0	4.8	3.8	2.2						56.0	
58.0				57.0m / 5.5	5.1	4.9	4.7	4.6	4.4	3.3	1.8						58.0	
60.0					59.7m / 4.8	4.5	4.4	4.2	4.0	2.8	1.6						60.0	
62.0						4.2	4.0	3.9	3.7	2.4							62.0	
64.0						62.3m / 4.1	3.7	3.6	3.3	1.9							64.0	
66.0							65.0m / 3.5	3.2	2.9	65.0m / 1.7							66.0	
68.0								67.6m / 3.0	2.4								68.0	
70.0									70.0m / 2.0								70.0	
Reeves	5	4	4	4	4	3	3	3	3	2	2							Reeves

Note: Ratings according to EN13000.

Ratings shown in are determined by the strength of the boom or other structural components.

Refer to notes P12.

Luffing Boom Working Ranges

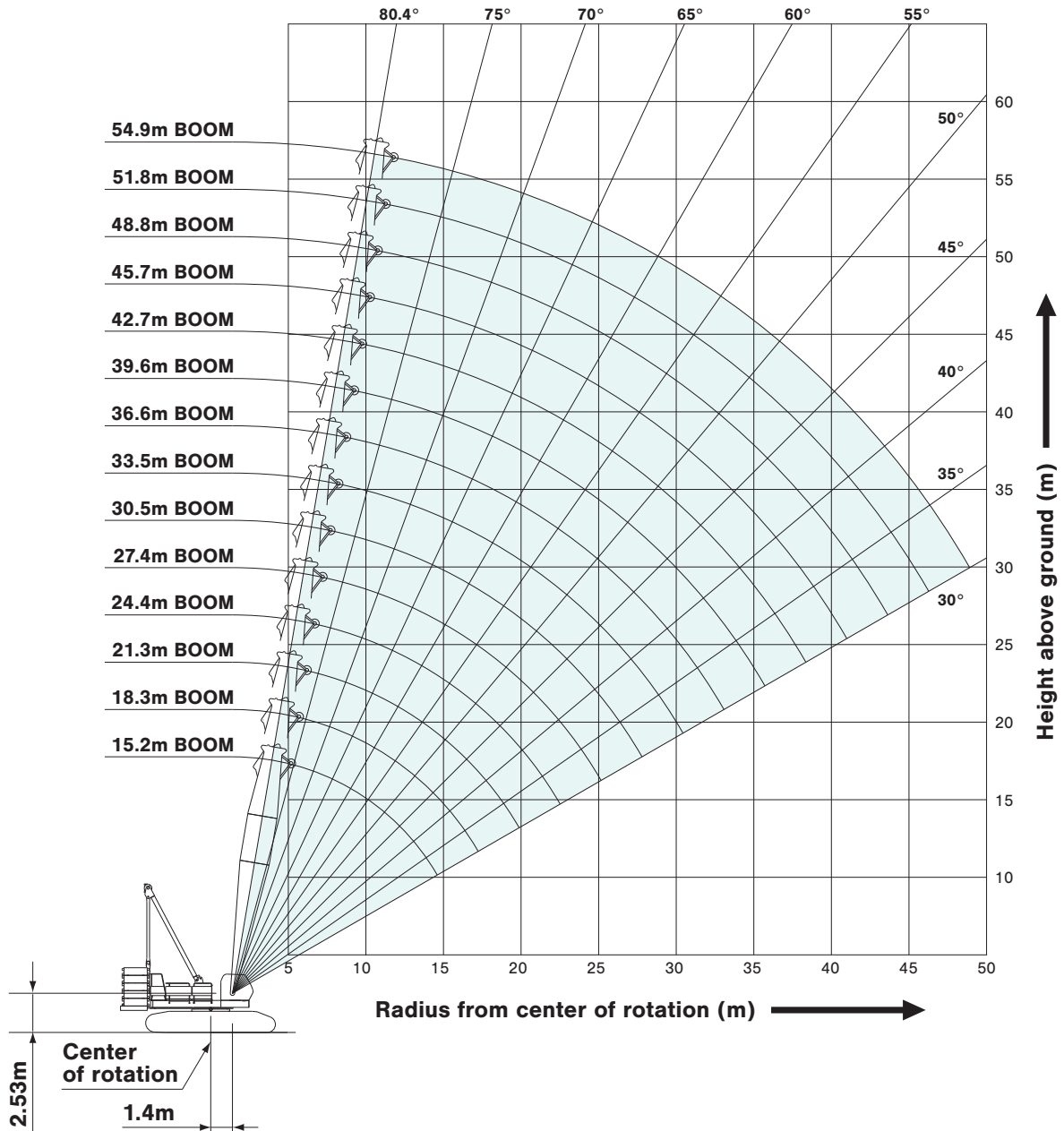

NOTES:

1. Ratings according to EN13000.
2. Ratings in metric tons for 360° working area.
3. Operating radius is the horizontal distance from center of rotation to a vertical line through the center of gravity of the load.
4. Deduct weight of hook block(s), slings and all other load handling accessories from long boom or jib ratings shown.
5. Ratings shown are based on freely suspended loads and make no allowance for such factors as wind effect on lifted load, ground conditions out-of-level, operating speeds or any other condition that could be detrimental to the safe operation of this equipment. Operator, therefore, has the responsibility to judge the existing conditions and reduce lifted loads and operating speeds accordingly.
6. Ratings are for operation on a firm and level surface, up to 1% gradient.
7. At radii and boom lengths where no ratings are shown on chart, operation is not intended nor approved.
8. Boom/ jib inserts and guy lines must be arranged as shown in the "Operator's Manual".

9. Boom hoist reeving is 16 part line.
10. Gantry must be in raised position for all conditions.
11. Boom backstops are required for all boom lengths.
12. The boom should be erected over the front of crawlers, not laterally.
13. Ratings shown in are determined by the strength of the boom or other structural component.
14. Instruction in the "Operator's Manual" must be strictly observed when operating the machine.
15. Luffing boom ratings: Deduct weight of hook block(s), slings and all other load handling accessories from luffing boom ratings shown.
16. Auxiliary sheave ratings: Deduct 0.6 ton (weight of auxiliary sheave frame), weight of hook block(s), slings and all other load handling accessories from luffing boom ratings shown, but should not exceed 26.8 tons.
Luffing boom lengths for auxiliary sheave mounting are 15.2 m to 54.9 m.
17. Luffing boom ratings with auxiliary sheave: Deduct 0.6 ton, weight of hook block(s), slings and all other load handling accessories from luffing boom ratings shown.



Luffing Boom Lifting Capacity

Unit: metric ton

Counterweight: 60.0 t
Carbody Weight: 20.0 t

Working radius (m)	Boom length (m)															Working radius (m)	
	15.2	18.3	21.3	24.4	27.4	30.5	33.5	36.6	39.6	42.7	45.7	48.8	51.8	54.9			
5.0	5.2m /110.0	5.7m /107.0															5.0
6.0	107.0	106.7	6.2m /106.2	6.8m /103.7													6.0
7.0	101.3	101.2	101.1	101.0	7.3m /96.8	7.8m /90.4											7.0
8.0	89.8	89.7	89.6	89.5	89.4	89.3	8.3m /85.5	8.8m /80.3									8.0
9.0	79.4	79.3	79.3	79.1	79.0	79.0	78.8	78.7	9.3m /75.5	9.8m /69.3							9.0
10.0	71.2	71.1	71.0	70.9	70.8	70.7	70.6	70.5	69.4	67.5	10.3m /64.0	10.8m /59.3	11.3m /55.1	11.8m /51.3			10.0
12.0	57.5	57.3	57.2	57.0	56.9	56.8	56.6	56.6	56.5	55.5	54.2	52.9	51.6	50.4			12.0
14.0	46.2	46.4	46.3	46.1	46.0	45.9	45.7	45.7	45.6	45.4	45.2	44.8	43.7	42.7			14.0
16.0	15.2m /39.2	39.0	38.9	38.6	38.5	38.4	38.2	38.1	38.0	37.8	37.7	37.6	37.4	36.9			16.0
18.0		17.8m /33.6	33.2	32.9	32.8	32.7	32.5	32.4	32.3	32.1	32.0	31.9	31.7	31.5			18.0
20.0			29.2	28.7	28.6	28.4	28.2	28.1	28.0	27.8	27.7	27.6	27.4	27.2			20.0
22.0			20.5m /28.0	25.3	25.2	25.1	24.8	24.7	24.6	24.4	24.2	24.2	24.0	23.8			22.0
24.0				23.1m /23.7	22.5	22.3	22.1	22.0	21.9	21.6	21.5	21.4	21.2	21.0			24.0
26.0					25.7m /20.4	20.1	19.8	19.7	19.6	19.3	19.2	19.1	18.9	18.7			26.0
28.0						18.2	17.9	17.8	17.7	17.5	17.3	17.2	17.0	16.8			28.0
30.0						28.4m /17.8	16.3	16.2	16.1	15.8	15.7	15.6	15.4	15.2			30.0
32.0							31.0m /15.6	14.8	14.7	14.4	14.3	14.2	13.9	13.8			32.0
34.0								33.7m /13.8	13.5	13.3	13.1	13.0	12.7	12.6			34.0
36.0									12.5	12.2	12.0	11.9	11.7	11.5			36.0
38.0									36.3m /12.3	11.2	11.0	10.9	10.7	10.5			38.0
40.0										38.9m /10.9	10.3	10.2	9.9	9.7			40.0
42.0											41.6m /9.7	9.4	9.1	9.0			42.0
44.0												8.8	8.5	8.3			44.0
46.0												44.2m /8.6	7.8	7.7			46.0
48.0													46.9m /7.6	7.1			48.0
50.0														49.5m /6.7			50.0
Reeves	8	8	8	8	8	7	7	6	6	6	5	5	5	4			Reeves

Note: Ratings according to EN13000.

Ratings shown in are determined by the strength of the boom or other structural components.

Refer to notes P14.

Long Boom Working Ranges

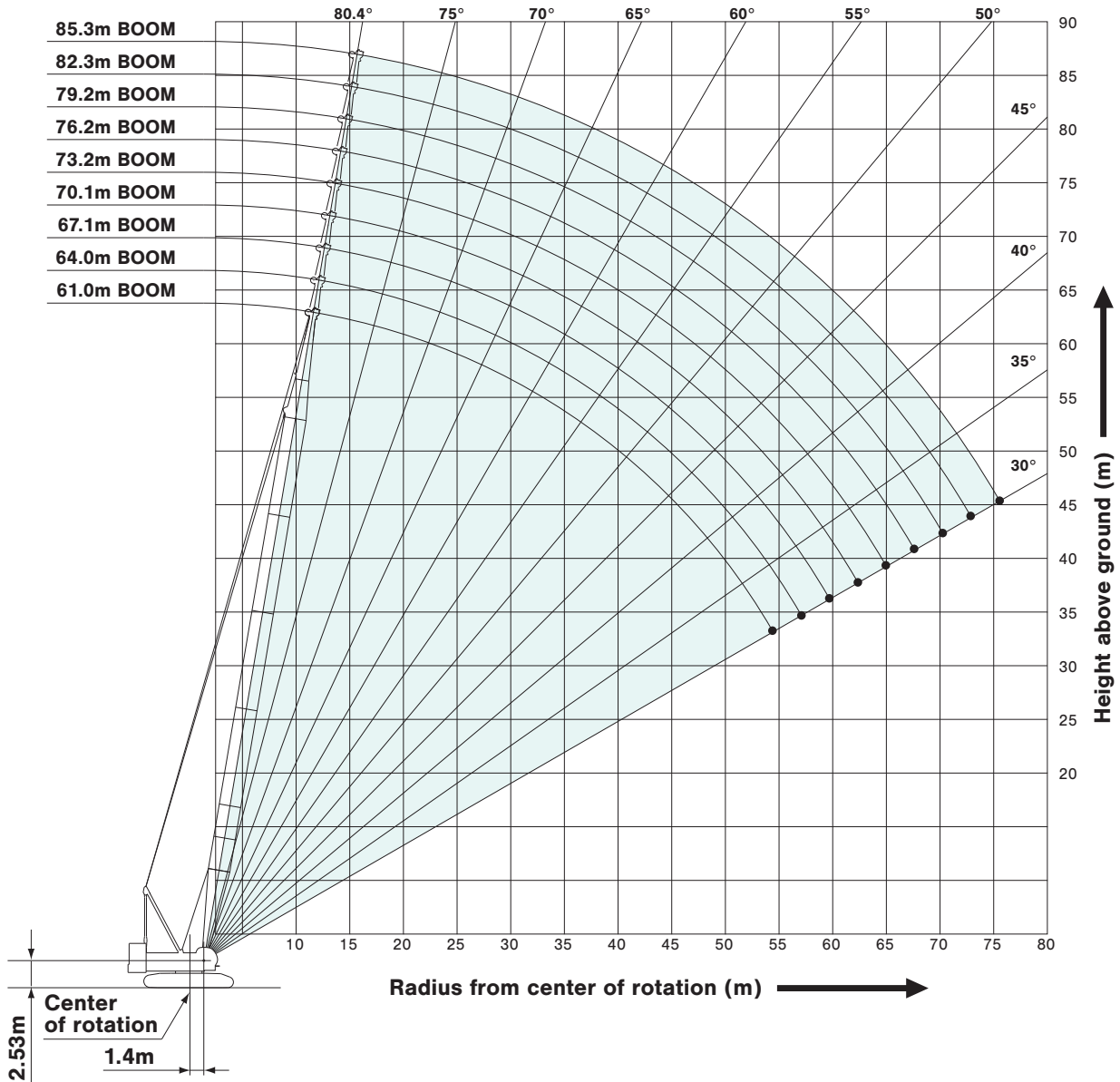

NOTES:

1. Ratings according to EN13000.
2. Ratings in metric tons for 360° working area.
3. Operating radius is the horizontal distance from center of rotation to a vertical line through the center of gravity of the load.
4. Deduct weight of hook block(s), slings and all other load handling accessories from long boom or jib ratings shown.
5. Ratings shown are based on freely suspended loads and make no allowance for such factors as wind effect on lifted load, ground conditions out-of-level, operating speeds or any other condition that could be detrimental to the safe operation of this equipment. Operator, therefore, has the responsibility to judge the existing conditions and reduce lifted loads and operating speeds accordingly.
6. Ratings are for operation on a firm and level surface, up to 1% gradient.
7. At radii and boom lengths where no ratings are shown on chart, operation is not intended nor approved.
8. Boom/ jib inserts and guy lines must be arranged as shown in the "Operator's Manual".
9. Boom hoist reeving is 16 part line.
10. Gantry must be in raised position for all conditions.
11. Boom backstops are required for all boom lengths.
12. Ratings shown in are determined by the strength of the boom or other structural component.
13. Instruction in the "Operator's Manual" must be strictly observed when operating the machine.
14. Long boom ratings: Deduct weight of hook block(s), slings and all other load handling accessories from long boom ratings shown.
15. Auxiliary sheave ratings: Deduct 0.4 ton (weight of auxiliary sheave frame), weight of hook block(s), slings and all other load handling accessories from long boom ratings shown, but should not exceed 13.5 tons.
Long boom length for auxiliary sheave mounting are 61.0 m to 79.2 m.



Long Boom Lifting Capacities

Unit: metric ton

Counterweight: 60.0 t
Carbody Weight: 20.0 t

Working radius (m) \ Boom length (m)	61.0	64.0	67.1	70.1	73.2	76.2	79.2	82.3	85.3	Working radius (m) \ Boom length (m)
10.0	11.9m /40.1									10.0
12.0	40.1	12.4m /37.8	12.9m /35.0	13.4m /33.2	13.9m /31.6					12.0
14.0	37.2	35.8	34.5	32.8	31.5	14.4m /27.9	14.9m /23.9	15.5m /20.7		14.0
16.0	34.1	33.1	32.1	30.6	29.5	26.5	23.2	20.4	20.3	16.0
18.0	31.0	30.3	29.6	28.4	27.5	24.9	21.9	19.4	19.3	18.0
20.0	27.9	27.4	27.1	26.2	25.5	23.3	20.6	18.4	18.3	20.0
22.0	24.9	24.7	24.5	24.0	23.5	21.7	19.5	17.4	17.3	22.0
24.0	22.1	22.0	21.9	21.8	21.5	20.1	18.3	16.4	16.4	24.0
26.0	19.8	19.7	19.6	19.6	19.5	18.5	17.1	15.5	15.5	26.0
28.0	17.9	17.8	17.7	17.6	17.5	17.0	16.0	14.7	14.7	28.0
30.0	16.3	16.2	16.1	16.0	15.9	15.5	14.9	13.9	13.9	30.0
32.0	14.9	14.8	14.6	14.6	14.5	14.1	13.7	13.0	13.0	32.0
34.0	13.6	13.5	13.4	13.4	13.2	12.9	12.8	12.3	12.3	34.0
36.0	12.6	12.5	12.3	12.3	12.2	11.9	11.8	11.5	11.5	36.0
38.0	11.6	11.5	11.4	11.3	11.2	10.9	10.9	10.8	10.8	38.0
40.0	10.8	10.7	10.5	10.5	10.4	10.1	10.0	10.0	10.0	40.0
42.0	10.0	9.9	9.8	9.7	9.6	9.4	9.3	9.3	9.3	42.0
44.0	9.3	9.2	9.1	9.0	8.9	8.7	8.6	8.6	8.6	44.0
46.0	8.7	8.6	8.5	8.4	8.3	8.1	8.0	8.0	8.0	46.0
48.0	8.2	8.0	7.9	7.9	7.7	7.5	7.4	7.4	7.4	48.0
50.0	7.7	7.5	7.4	7.3	7.2	7.0	6.9	6.9	6.9	50.0
52.0	7.2	7.1	6.9	6.9	6.7	6.5	6.5	6.5	6.5	52.0
54.0	6.8	6.6	6.5	6.4	6.3	6.1	6.0	6.0	6.0	54.0
56.0	54.5m /6.7	6.3	6.1	6.1	5.9	5.7	5.7	5.7	5.6	56.0
58.0		57.2m /6.0	5.8	5.7	5.6	5.4	5.3	5.3	5.2	58.0
60.0			59.8m /5.5	5.4	5.2	5.0	5.0	5.0	4.8	60.0
62.0				5.0	4.9	4.7	4.6	4.6	4.4	62.0
64.0				62.4m /5.0	4.6	4.4	4.4	4.3	4.1	64.0
66.0					65.1m /4.5	4.2	4.1	4.0	3.8	66.0
68.0						67.7m /3.9	3.8	3.7	3.5	68.0
70.0							3.5	3.5	3.2	70.0
72.0							70.4m /3.4	3.2	3.0	72.0
74.0								73.0m /3.1	2.8	74.0
76.0									75.6m /2.6	76.0
Reeves	3	3	3	3	3	3	2	2	2	Reeves

Note: Ratings according to EN13000.

Ratings shown in are determined by the strength of the boom or other structural components.

Refer to notes P16.

Fixed Jib Working Ranges

Jib Offset Angle: 10°, 30°

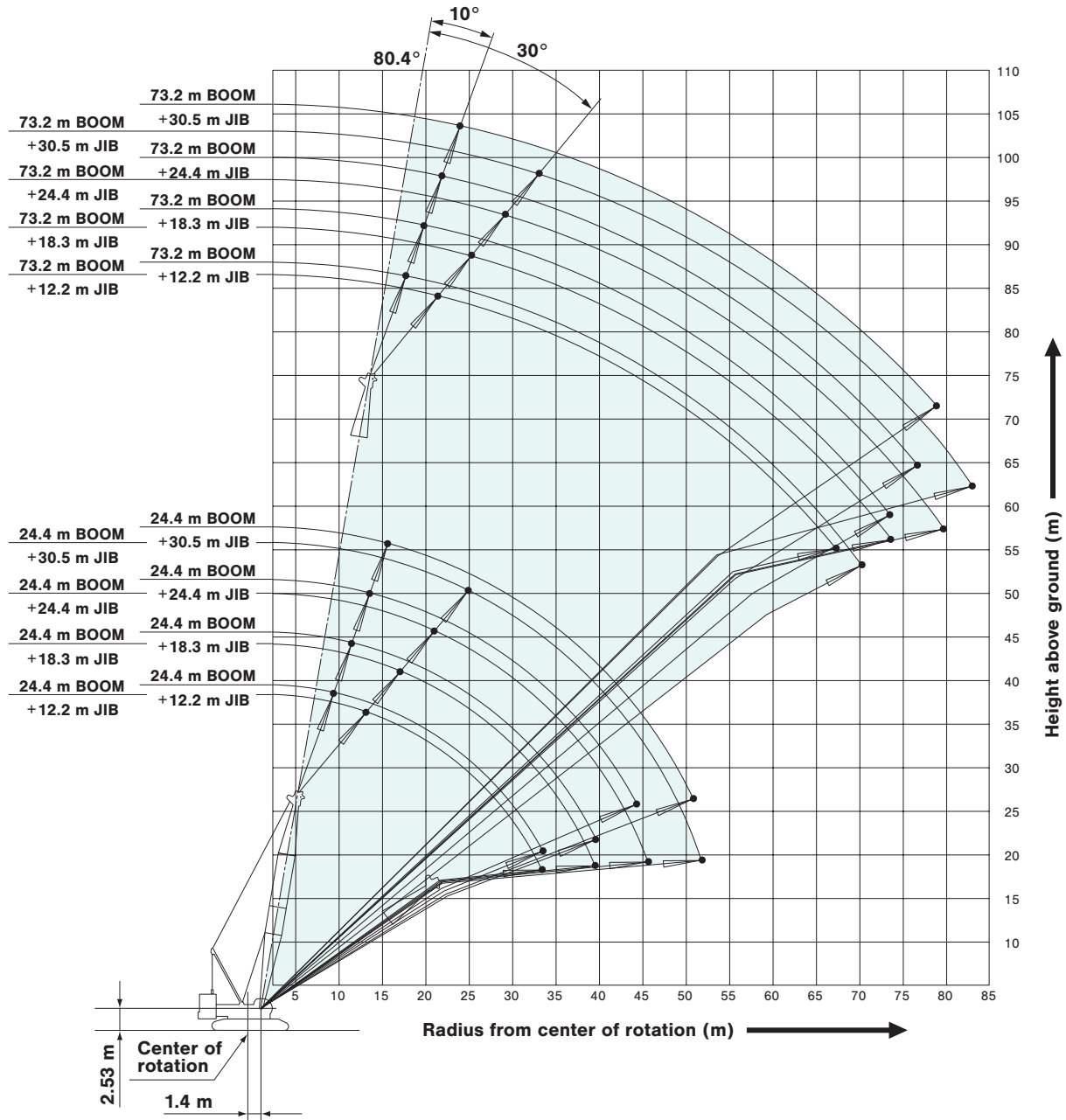

NOTES:

1. Ratings according to EN 13000.
2. Ratings in metric tons for 360° working area.
3. Operating radius is the horizontal distance from center of rotation to a vertical line through the center of gravity of the load.
4. Deduct weight of hook block (s), slings and all other load handling accessories from fixed jib ratings shown.
5. Ratings shown are based on freely suspended loads and make no allowance for such factors as wind effect on lifted load, ground conditions out-of-level, operating speeds or any other condition that could be detrimental to the safe operation of this equipment. Operator, therefore, has the responsibility to judge the existing conditions and reduce lifted loads and operating speeds accordingly.
6. Ratings are for operation on a firm and level surface, up to 1% gradient.
7. At radii and boom lengths where no ratings are shown on chart, operation is not intended nor approved.
8. Boom inserts and guy lines must be arranged as shown in the "Operator's Manual".
9. Boom hoist reeving is 16 part line.
10. Gantry must be in raised position for all conditions.
11. Boom backstops are required for all boom lengths.
12. Ratings shown in are determined by the strength of the boom or other structural component.
13. The boom should be erected over the front of the crawlers not laterally.
14. Instruction in the "Operator's Manual" must be strictly observed when operating the machine.
15. Fixed jib ratings: Deduct weight of hook block (s), slings, and all other load handling accessories from jib ratings shown.
16. Boom lengths for jib mounting are 24.4 m to 73.2 m.
17. One part of line on hook is not allowed to use for 12.2 m jib length with offset angle 10 degrees.



Fixed Jib Lifting Capacities (Without Main Hook)

Unit: metric ton

Jib Offset Angle: 10°

Counterweight: 60.0 t
Carbody Weight: 20.0 t

Boom length (m)		24.4				33.5				42.7				51.8				Boom length (m)	
Jib length (m)		12.2	18.3	24.4	30.5	12.2	18.3	24.4	30.5	12.2	18.3	24.4	30.5	12.2	18.3	24.4	30.5	Jib length (m)	
Working radius (m)	9.0	9.8m/26.8																	9.0
	10.0	26.8	11.0m/19.5			11.0m/26.8													10.0
	12.0	26.5	19.3	12.8m/10.1		26.3	12.8m/19.4			12.2m/26.8									12.0
	14.0	23.1	18.9	9.9	14.0m/6.1	24.3	19.1	14.6m/10.1		26.0	14.6m/19.3			14.0m/26.8					14.0
	16.0	20.7	18.1	9.7	5.9	22.8	18.7	9.9	16.8m/6.0	24.6	19.1	16.8m/10.0		26.0	16.8m/19.2				16.0
	18.0	19.2	17.5	9.5	5.8	21.4	18.2	9.7	5.9	23.2	18.6	9.9	18.3m/6.0	24.6	18.9	18.3m/9.9	19.8m/6.0		18.0
	20.0	18.0	16.2	9.3	5.6	20.1	17.6	9.5	5.8	21.9	18.1	9.7	5.9	23.4	18.5	9.8	6.0		20.0
	22.0	16.9	14.3	8.8	5.3	19.1	16.7	9.3	5.6	20.8	17.7	9.5	5.8	22.3	18.1	9.7	5.9		22.0
	24.0	16.0	13.2	8.4	5.0	18.1	15.4	9.0	5.4	19.8	17.2	9.4	5.7	21.3	17.8	9.5	5.8		24.0
	26.0	15.2	12.2	8.1	4.8	17.1	14.3	8.7	5.2	18.9	16.1	9.2	5.5	20.0	17.4	9.4	5.6		26.0
	28.0	14.4	11.3	7.8	4.6	16.4	13.3	8.3	4.9	18.0	15.1	8.8	5.3	18.1	16.7	9.3	5.5		28.0
	30.0	13.7	10.6	7.4	4.4	15.7	12.5	8.0	4.7	16.8	14.2	8.6	5.0	16.4	15.7	9.0	5.3		30.0
	34.0	33.5m/12.7	9.4	6.9	4.0	14.5	11.1	7.5	4.4	14.2	12.6	8.0	4.7	13.7	13.9	8.5	4.9		34.0
	38.0		8.4	6.5	3.7	12.7	10.0	7.1	4.0	12.2	11.4	7.6	4.4	11.6	11.8	8.0	4.6		38.0
	42.0		39.6m/8.2	6.2	3.4	39.6m/12.0	9.1	6.7	3.8	10.5	10.4	7.2	4.1	9.9	10.2	7.6	4.4		42.0
	46.0			44.2m/6.1	3.2		45.7m/8.4	6.4	3.5	9.2	9.4	6.8	3.9	8.6	8.8	7.3	4.1		46.0
	50.0				3.0			6.1	3.3	48.8m/8.4	8.3	6.5	3.6	7.5	7.7	6.9	3.9		50.0
	54.0				50.3m/3.0			51.8m/6.1	3.2		7.3	6.3	3.4	6.5	6.8	6.7	3.7		54.0
	58.0								57.9m/3.0		54.9m/7.1	6.1	3.3	57.9m/5.8	5.9	6.2	3.5		58.0
	62.0											61.0m/6.0	3.1		61.0m/5.4	5.5	3.4		62.0
66.0												3.0			4.9	3.2		66.0	
70.0												67.1m/3.0			67.1m/4.7	3.1		70.0	
74.0																73.2m/3.0		74.0	
Reeves	2	2	1	1	2	2	1	1	2	2	1	1	2	2	1	1	Reeves		

Boom length (m)		61.0				70.1				73.2				Boom length (m)	
Jib length (m)		12.2	18.3	24.4	30.5	12.2	18.3	24.4	30.5	12.2	18.3	24.4	30.5	Jib length (m)	
Working radius (m)	16.0	16.8m/26.6				16.8m/21.7									16.0
	18.0	25.9	18.3m/19.1	19.8m/9.9		21.4	19.8m/19.1			18.3m/19.1	19.8m/18.7				18.0
	20.0	24.7	18.8	9.9	21.3m/6.0	21.0	19.1	21.3m/9.9		18.8	18.7	21.3m/9.9			20.0
	22.0	23.6	18.5	9.8	5.9	20.6	18.7	9.9	22.9m/5.9	18.4	18.3	9.9	22.9m/6.0		22.0
	24.0	21.8	18.1	9.7	5.9	20.2	18.4	9.8	5.9	18.0	17.9	9.8	5.9		24.0
	26.0	19.6	17.8	9.5	5.7	19.1	18.1	9.7	5.8	17.6	17.5	9.7	5.8		26.0
	28.0	17.6	17.3	9.4	5.6	17.1	17.4	9.5	5.7	16.9	16.9	9.5	5.7		28.0
	30.0	15.9	16.1	9.3	5.5	15.4	15.7	9.4	5.6	15.2	15.6	9.4	5.6		30.0
	34.0	13.2	13.4	8.8	5.2	12.7	13.0	9.2	5.4	12.5	12.8	9.2	5.4		34.0
	38.0	11.1	11.3	8.4	4.9	10.6	10.9	8.7	5.1	10.4	10.7	8.8	5.2		38.0
	42.0	9.4	9.7	8.0	4.6	8.9	9.2	8.3	4.8	8.8	9.0	8.4	4.9		42.0
	46.0	8.0	8.3	7.6	4.4	7.6	7.8	7.9	4.6	7.3	7.6	8.0	4.6		46.0
	50.0	6.9	7.2	7.3	4.1	6.5	6.7	7.1	4.3	6.3	6.5	6.8	4.4		50.0
	54.0	6.0	6.2	6.5	3.9	5.5	5.8	6.1	4.1	5.3	5.5	5.9	4.2		54.0
	58.0	5.2	5.4	5.7	3.7	4.6	4.9	5.3	3.9	4.4	4.6	5.1	4.0		58.0
	62.0	4.4	4.7	5.0	3.5	3.8	4.1	4.5	3.8	3.5	3.8	4.2	3.8		62.0
	66.0	64.0m/4.1	4.0	4.4	3.4	3.1	3.4	3.8	3.6	2.8	3.0	3.5	3.6		66.0
	70.0		3.4	3.7	3.3	2.4	2.7	3.1	3.3	2.1	2.4	2.8	2.9		70.0
	74.0		70.1m/3.4	3.1	3.2	73.2m/2.0	2.1	2.5	2.7	70.1m/2.1	73.2m/2.0	2.3	2.4		74.0
	78.0			76.2m/2.9	2.8		76.2m/1.9	2.0	2.2			76.2m/2.0	77.7m/2.0		78.0
82.0				2.3			79.2m/1.9	80.8m/1.9						82.0	
86.0				82.3m/2.3										86.0	
Reeves	2	2	1	1	2	2	1	1	2	2	1	1	Reeves		

Note: Ratings according to EN13000.

Ratings shown in are determined by the strength of the boom or other structural components.

Refer to notes P18.

※ One part of line on hook is not allowed to use for 12.2 m jib length with offset angle 10 degrees.

Unit: metric ton

Jib Offset Angle: 30°

Counterweight: 60.0 t
Carbody Weight: 20.0 t

Boom length (m)		24.4				33.5				42.7				51.8				Boom length (m)	
Jib length (m)		12.2	18.3	24.4	30.5	12.2	18.3	24.4	30.5	12.2	18.3	24.4	30.5	12.2	18.3	24.4	30.5	Jib length (m)	
Working radius (m)	12.0	13.4m/17.2																12.0	
	14.0	17.2				14.6m/17.2												14.0	
	16.0	16.0	16.8m/12.8			16.8				16.8m/17.1								16.0	
	18.0	15.2	12.2			16.1	18.3m/12.8			16.7	19.8m/12.8			18.3m/17.1				18.0	
	20.0	14.3	11.2	21.3m/7.5		15.6	12.1			16.1	12.8			16.6	21.3m/12.8			20.0	
	22.0	13.5	10.5	7.4		14.8	11.4	22.9m/7.5		15.7	12.1			16.2	12.6			22.0	
	24.0	12.7	9.8	7.2	24.4m/4.1	14.1	10.8	7.4	25.9m/4.1	15.2	11.4	24.4m/7.5		15.8	12.0	25.9m/7.5		24.0	
	26.0	12.1	9.3	7.0	4.0	13.4	10.2	7.2	4.1	14.5	10.9	7.4	27.4m/4.1	15.3	11.5	7.5		26.0	
	28.0	11.6	8.8	6.8	3.9	12.8	9.7	7.0	4.0	13.9	10.4	7.2	4.1	14.8	11.0	7.4	29.0m/4.1	28.0	
	30.0	11.2	8.3	6.5	3.7	12.3	9.2	6.8	3.9	13.4	9.9	7.1	4.0	14.2	10.5	7.2	4.0	30.0	
	34.0	33.5m/10.6	7.6	5.9	3.4	11.5	8.4	6.4	3.6	12.5	9.1	6.8	3.8	13.3	9.8	6.9	3.9	34.0	
	38.0		7.1	5.4	3.3	36.6m/11.1	7.8	5.9	3.4	11.7	8.5	6.4	3.5	11.9	9.1	6.7	3.7	38.0	
	42.0		39.6m/7.0	5.0	3.1		7.4	5.5	3.3	10.7	8.0	5.9	3.4	10.2	8.6	6.3	3.5	42.0	
	46.0			45.7m/4.8	3.0		42.7m/7.3	5.2	3.1	45.7m/9.4	7.5	5.6	3.3	8.8	8.1	5.9	3.4	46.0	
	50.0				2.9			48.8m/5.0	3.0		7.2	5.3	3.1	7.6	7.7	5.6	3.2	50.0	
	54.0				51.8m/2.9				2.9		51.8m/7.1	5.0	3.0	51.8m/7.2	7.1	5.4	3.2	54.0	
	58.0								54.9m/2.9			57.9m/4.9	2.9		57.9m/6.2	5.1	3.0	58.0	
	62.0												2.9			4.9	3.0	62.0	
66.0												64.0m/2.9			64.0m/4.9	2.9	66.0		
70.0																2.9	70.0		
74.0																70.1m/2.9	74.0		
Reeves	2	1	1	1	2	1	1	1	2	1	1	1	2	1	1	1	Reeves		

Boom length (m)		61.0				70.1				73.2				Boom length (m)	
Jib length (m)		12.2	18.3	24.4	30.5	12.2	18.3	24.4	30.5	12.2	18.3	24.4	30.5	Jib length (m)	
Working radius (m)	18.0	19.8m/17.1													18.0
	20.0	17.0				21.3m/17.1				21.3m/17.2					20.0
	22.0	16.6	22.9m/12.8			16.9				17.1					22.0
	24.0	16.2	12.5			16.6	24.4m/13.2			16.7	25.9m/12.9				24.0
	26.0	15.9	12.0	27.4m/7.5		16.2	12.8			16.4	12.9				26.0
	28.0	15.5	11.5	7.5		15.9	12.3	29.0m/7.5		16.0	12.4	29.0m/7.6			28.0
	30.0	15.0	11.0	7.3	30.5m/4.1	15.6	11.8	7.5	32.0m/4.1	15.6	12.0	7.5	32.0m/4.1		30.0
	34.0	13.6	10.3	7.1	3.9	13.2	11.1	7.2	4.0	13.1	11.2	7.3	4.0		34.0
	38.0	11.4	9.6	6.8	3.8	11.1	10.4	7.0	3.8	10.9	10.5	7.0	3.9		38.0
	42.0	9.7	9.1	6.6	3.6	9.3	9.8	6.8	3.7	9.1	9.8	6.8	3.7		42.0
	46.0	8.3	8.6	6.3	3.4	7.9	8.5	6.6	3.5	7.7	8.3	6.7	3.6		46.0
	50.0	7.1	7.6	5.9	3.4	6.7	7.3	6.4	3.4	6.5	7.1	6.5	3.4		50.0
	54.0	6.2	6.6	5.7	3.3	5.8	6.3	6.1	3.4	5.6	6.1	6.2	3.4		54.0
	58.0	57.9m/5.3	5.8	5.4	3.1	4.9	5.4	5.7	3.2	4.6	5.2	5.6	3.3		58.0
	62.0		5.0	5.2	3.0	4.0	4.6	4.9	3.1	3.7	4.4	4.8	3.2		62.0
	66.0		64.0m/4.7	4.6	3.0	3.2	3.8	4.2	3.1	2.9	3.6	4.0	3.1		66.0
	70.0			4.0	2.9	67.1m/3.0	3.1	3.5	3.0	67.1m/2.8	2.9	3.3	3.0		70.0
	74.0			70.1m/4.0	2.9		73.2m/2.6	2.9	2.9		73.2m/2.4	2.6	2.9		74.0
78.0				76.2m/2.9			2.3	2.6			2.0	2.4		78.0	
82.0							79.2m/2.1	2.0			79.2m/1.9	1.8		82.0	
84.0								83.8m/1.8				82.3m/1.8		84.0	
Reeves	2	1	1	1	2	1	1	1	2	1	1	1	Reeves		

Note: Ratings according to EN13000.

Ratings shown in are determined by the strength of the boom or other structural components.

Refer to notes P18.

Luffing Jib Working Ranges

Boom Angle: 88°

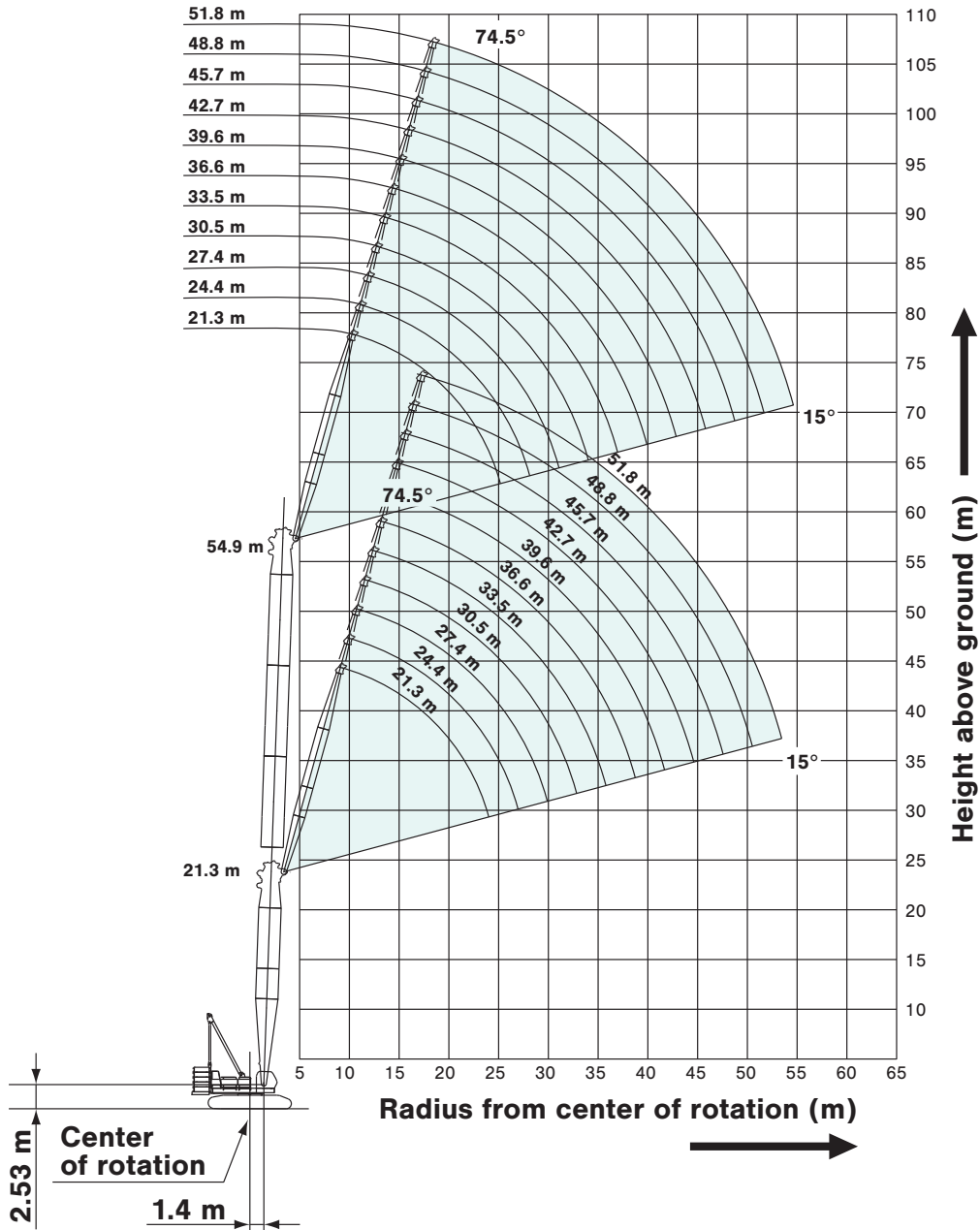

NOTES:

1. Ratings according to EN13000.
2. Ratings in metric tons for 360° working area.
3. Operating radius is the horizontal distance from center of rotation to a vertical line through the center of gravity of the load.
4. Deduct weight of hook block(s), slings and all other load handling accessories from luffing jib ratings or main boom ratings with luffing jib shown.
5. Ratings shown are based on freely suspended loads and make no allowance for such factors as wind effect on lifted load, ground conditions out-of-level, operating speeds or any other condition that could be detrimental to the safe operation of this equipment. Operator, therefore, has the responsibility to judge the existing conditions and reduce lifted loads and operating speeds accordingly.
6. Ratings are for operation on a firm and level surface, up to 1% gradient.
7. At radii and boom lengths where no ratings are shown on chart, operation is not intended nor approved.
8. Boom/jib inserts and guy lines must be arranged as shown in the "Operator's Manual".
9. Luffing boom hoist reeving is 16 part line.
10. Jib hoist reeving is 8 part line.

Boom Angle: 60°

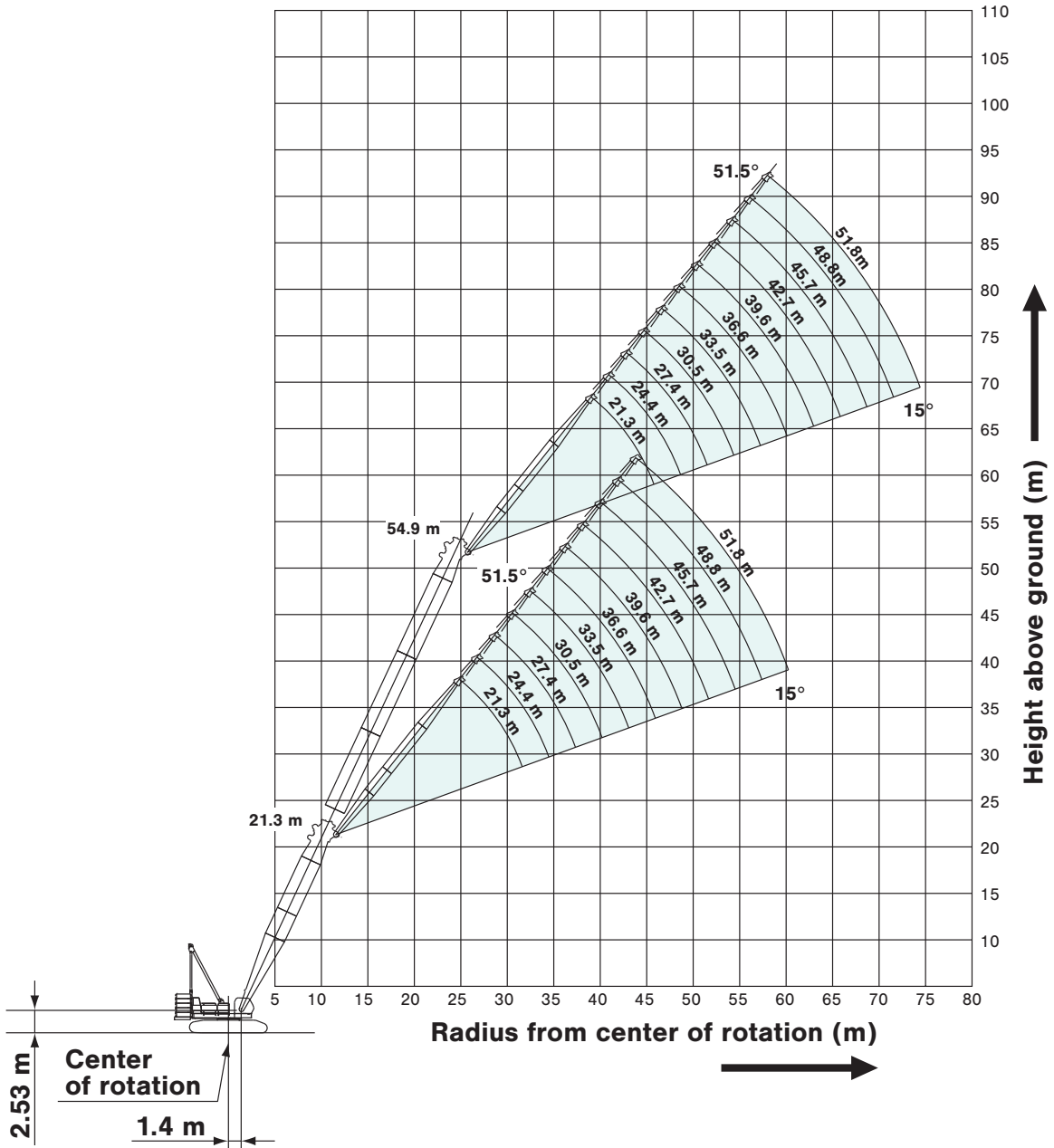

11. Gantry must be in raised position for all conditions.
12. Boom and jib backstops are required for all boom and jib combinations.
13. Ratings shown in are determined by the strength of the boom or other structural component.
14. The boom should be erected over the front of crawlers, not laterally.
15. When erecting and lowering the all boom and jib combinations, the pillow plate for erection must be placed at the end of crawlers.
16. Instruction in the "Operator's Manual" must be strictly observed when operating the machine.

17. The minimum rated load is 2.0 tons.
18. Luffing jib ratings: Deduct weight of hook block(s), slings, and all other load handling accessories from luffing jib ratings shown.
19. Main boom ratings with luffing jib: Deduct weight of hook block(s), slings, and all other load handling accessories from main boom ratings with luffing jib shown.



Luffing Jib Lifting Capacities (Without Main Hook)

Unit: metric ton

Counterweight: 60.0 t
Carbody Weight: 20.0 t

21.3m Boom Length	21.3																Boom length (m)	
	21.3				27.4				33.5				39.6				Jib length (m)	
	88°		83°		65°		60°		88°		83°		65°		60°		Boom angle	
Working radius (m)	9.14	48.6															9.14	
	10.0	48.3															10.0	
	12.0	47.7				47.4											12.0	
	14.0	43.3	47.4			43.2			42.9				34.6				14.0	
	16.0	35.8	40.9			35.7	40.7			35.4			33.5				16.0	
	18.0	30.4	35.1			30.2	34.9			30.0	34.7		29.7				18.0	
	20.0	26.2	30.2			26.2	30.1			25.9	30.3		25.6	30.0			20.0	
	22.0	23.0	26.1			22.9	26.0			22.7	26.1		22.4	25.9			22.0	
	24.0		22.9			20.4	22.8			20.1	22.9		19.9	22.7			24.0	
	26.0			20.3		18.2	20.3			18.0	20.3		17.7	20.1			26.0	
	28.0			18.6		16.5	18.2			16.2	18.2		16.0	17.9			28.0	
	30.0			17.1	16.7		16.4	16.7		14.7	16.4		14.5	16.2			30.0	
	34.0				32.0m/15.4			14.3	13.8	32.0m/13.4	13.6	13.9		12.1	13.4		34.0	
	38.0							36.0m/13.3	12.1		36.0m/12.5	12.2	11.7	10.3	11.2	11.8	38.0	
	42.0											10.7	10.5		9.6	10.5	10.0	42.0
	46.0												44.0m/9.8			9.3	9.0	46.0
	50.0															48.0m/8.8	8.1	50.0
Reeves	4				4				4				3				Reeves	

21.3m Boom Length	21.3								Boom length (m)
	45.7				51.8				Jib length (m)
	88°		83°		65°		60°		Boom angle
Working radius (m)	18.0	22.9							18.0
	20.0	21.2				16.3			20.0
	22.0	19.8	21.5			15.1			22.0
	24.0	18.4	19.7			14.1			24.0
	26.0	17.3	18.4			13.0	14.0		26.0
	28.0	15.9	17.3			12.3	13.1		28.0
	30.0	14.4	16.2			11.5	12.3		30.0
	34.0	12.0	13.3			10.2	10.8		34.0
	38.0	10.1	11.2			9.1	9.6		38.0
	42.0	8.6	9.5	10.0		8.2	8.6		42.0
	46.0	44.0m/8.0	8.2	9.1	8.5	7.3	7.7	8.7	46.0
50.0		48.0m/7.6	8.1	7.8	6.3	6.8	7.8	52.0m/7.1	50.0
54.0			7.2	7.0		52.0m/6.3	6.9	6.6	54.0
58.0				56.0m/6.6			58.0m/6.2	6.0	58.0
62.0								5.4	62.0
Reeves	2				2				Reeves

Note: Ratings according to EN13000.
Ratings shown in are determined by the strength of the boom or other structural components.
Refer to notes P21 and P22.

Unit: metric ton

Counterweight: 60.0 t
Carbody Weight: 20.0 t

27.4m Boom Length	27.4																Boom length (m)	
	21.3				27.4				33.5				39.6				Jib length (m)	
	Boom angle	88°	83°	65°	60°	88°	83°	65°	60°	88°	83°	65°	60°	88°	83°	65°	60°	Boom angle
Working radius (m)	10.0	47.4																10.0
	12.0	47.4			47.4													12.0
	14.0	44.6	47.4		44.5				44.2				34.6					14.0
	16.0	36.7	40.6		36.6				36.4				33.7					16.0
	18.0	31.0	34.8		30.9	34.6			30.7				30.5					18.0
	20.0	26.7	30.4		26.7	30.2			26.5	30.0			26.2	29.7				20.0
	22.0	23.4	26.9		23.4	26.7			23.1	26.6			22.9	26.4				22.0
	24.0		24.1		20.7	23.9			20.5	23.8			20.2	23.6				24.0
	26.0		21.2		18.5	21.3			18.3	21.4			18.0	21.1				26.0
	28.0				16.7	19.0			16.5	19.1			16.2	18.8				28.0
	30.0			16.4		17.1			14.9	17.1			14.7	16.9				30.0
	34.0			32.0m/15.1	13.5			13.7	32.0m/13.6	14.1	36.0m/12.2		12.2	13.9				34.0
	38.0				36.0m/12.6			11.9	11.5		36.0m/12.9	11.7	40.0m/10.2	10.3	11.7	40.0m/10.4		38.0
	42.0							40.0m/10.8				10.2	9.8		9.9	10.0		42.0
	46.0										44.0m/9.6	8.7			8.8	8.5		46.0
	50.0														7.9	7.5		50.0
	54.0															52.0m/7.1		54.0
	Reeves		4			4				4				3				Reeves

27.4m Boom Length	27.4								Boom length (m)	
	45.7				51.8				Jib length (m)	
	Boom angle	88°	83°	65°	60°	88°	83°	65°	60°	Boom angle
Working radius (m)	18.0	23.0								18.0
	20.0	21.4			16.5					20.0
	22.0	19.9			15.2					22.0
	24.0	18.5	20.2		14.1					24.0
	26.0	17.4	18.9		13.2	14.3				26.0
	28.0	16.2	17.7		12.3	13.4				28.0
	30.0	14.6	16.6		11.5	12.5				30.0
	34.0	12.1	13.9		10.2	11.0				34.0
	38.0	10.2	11.6		9.1	9.8				38.0
	42.0	8.7	9.9	44.0m/8.8	8.2	8.8				42.0
	46.0	44.0m/8.1	8.4	8.6	7.4	7.8	48.0m/7.6			46.0
	50.0		48.0m/7.8	7.6	7.2	4.5	6.9	7.3		50.0
	54.0			6.8	6.5		4.4	6.5	6.2	54.0
	58.0			56.0m/6.4	5.8			5.8	5.5	58.0
	62.0							5.2	4.9	62.0
	66.0								64.0m/4.6	66.0
	Reeves		2			2				Reeves

Note: Ratings according to EN13000.
Ratings shown in are determined by the strength of the boom or other structural components.
Refer to notes P21 and P22.

Unit: metric ton

Counterweight: 60.0 t
Carbody Weight: 20.0 t

33.5m Boom Length	33.5																Boom length (m)
	21.3				27.4				33.5				39.6				Jib length (m)
	88°	83°	65°	60°	88°	83°	65°	60°	88°	83°	65°	60°	88°	83°	65°	60°	Boom angle
10.0	47.4																10.0
12.0	47.4				47.4												12.0
14.0	45.7	47.4			45.6				42.6								14.0
16.0	37.5	40.2			37.5				37.2				33.0				16.0
18.0	31.6	34.4			31.6	34.2			31.4				31.3				18.0
20.0	27.2	30.1			27.2	30.0			26.9	29.6			27.2				20.0
22.0	23.7	26.6			23.7	26.5			23.5	26.3			23.7	25.9			22.0
24.0		23.9			21.0	23.8			20.8	23.5			20.9	23.4			24.0
26.0		21.5			18.7	21.5			18.5	21.2			18.6	21.1			26.0
28.0					16.8	19.5			16.7	19.3			16.7	19.2			28.0
30.0			32.0m/14.4			17.9			15.1	17.7			15.1	17.6			30.0
34.0			13.3	36.0m/11.9			36.0m/12.2		32.0m/13.7	14.6			12.6	14.4			34.0
38.0				11.1			11.3	40.0m/9.8		36.0m/13.3	10.7		10.6	12.1			38.0
42.0							40.0m/10.6	9.5			9.7	44.0m/8.3		10.2	44.0m/8.8		42.0
46.0								44.0m/8.9			8.5	8.1			8.3	48.0m/7.0	46.0
50.0												7.2			7.4	6.9	50.0
54.0															52.0m/7.0	6.2	54.0
58.0																56.0m/5.9	58.0
Reeves			4				4				4				3		Reeves

33.5m Boom Length	33.5								Boom length (m)
	45.7				51.8				Jib length (m)
	88°	83°	65°	60°	88°	83°	65°	60°	Boom angle
18.0	23.2							18.0	
20.0	21.5				16.6			20.0	
22.0	20.0				15.3			22.0	
24.0	18.6	20.9			14.2			24.0	
26.0	17.4	19.3			13.2	14.7		26.0	
28.0	16.4	18.0			12.3	13.7		28.0	
30.0	14.8	16.9			11.6	12.8		30.0	
34.0	12.3	14.5			10.3	11.2		34.0	
38.0	10.3	12.1			9.1	10.0		38.0	
42.0	8.8	10.2			8.2	8.9		42.0	
46.0	44.0m/8.1	8.7	7.6		6.3	7.9		46.0	
50.0		48.0m/8.1	7.1	52.0m/5.8	4.1	6.7	52.0m/6.4	50.0	
54.0			6.3	5.8		4.1	6.0	54.0	
58.0			5.7	5.2			5.3	58.0	
62.0				4.6			4.7	62.0	
66.0							64.0m/4.5	66.0	
70.0							68.0m/3.6	70.0	
Reeves			2				2	Reeves	

Note: Ratings according to EN13000.
Ratings shown in are determined by the strength of the boom or other structural components.
Refer to notes P21 and P22.

Unit: metric ton

Counterweight: 60.0 t
Carbody Weight: 20.0 t

39.6m Boom Length	39.6																Boom length (m)	
	21.3				27.4				33.5				39.6				Jib length (m)	
	Boom angle	88°	83°	65°	60°	88°	83°	65°	60°	88°	83°	65°	60°	88°	83°	65°	60°	Boom angle
Working radius (m)	10.0	47.4																10.0
	12.0	47.4			47.4													12.0
	14.0	43.4			43.0				37.7									14.0
	16.0	38.1	39.7		37.7				37.0				29.8					16.0
	18.0	32.2	34.2		32.1				31.9				29.3					18.0
	20.0	27.6	29.8		27.6	29.6			27.4	29.2			27.6					20.0
	22.0	24.0	26.4		24.1	26.2			23.9	25.9			24.0	25.5				22.0
	24.0		23.7		21.2	23.5			21.0	23.2			21.2	23.1				24.0
	26.0		21.4		18.9	21.2			18.7	20.9			18.8	20.9				26.0
	28.0				17.0	19.3			16.8	19.0			16.9	19.0				28.0
	30.0					17.7			15.2	17.4			15.3	17.4				30.0
	34.0			12.4		32.0m/16.3			32.0m/13.8	14.8			12.7	14.7				34.0
	38.0			11.0	10.1			10.4		12.6			10.7	12.4				38.0
	42.0				9.1			9.4	44.0m/8.2			8.7		10.5				42.0
	46.0							44.0m/8.8	7.7			8.0	7.1	44.0m/9.7	7.7			46.0
	50.0											7.1	6.6		6.9	52.0m/5.9		50.0
	54.0												52.0m/6.2		6.1	5.6		54.0
	58.0														56.0m/5.8	4.9		58.0
	Reeves			4			4			4				3				Reeves

39.6m Boom Length	39.6								Boom length (m)	
	45.7				51.8				Jib length (m)	
	Boom angle	88°	83°	65°	60°	88°	83°	65°	60°	Boom angle
Working radius (m)	18.0	23.3								18.0
	20.0	21.6			16.7					20.0
	22.0	20.1			15.4					22.0
	24.0	18.7			14.3					24.0
	26.0	17.6	19.8		13.2	15.1				26.0
	28.0	16.5	18.5		12.3	14.0				28.0
	30.0	15.0	17.1		11.6	13.1				30.0
	34.0	12.4	14.5		10.3	11.5				34.0
	38.0	10.4	12.5		9.2	10.2				38.0
	42.0	8.8	10.5		8.2	9.1				42.0
	46.0	44.0m/8.2	8.9		6.0	8.1				46.0
	50.0		48.0m/8.3	6.5	3.7	6.6	52.0m/5.6			50.0
	54.0			5.8	56.0m/4.7	3.9	5.4			54.0
	58.0			5.1	4.6		4.8	60.0m/3.8		58.0
	62.0			4.6	4.0		4.2	3.7		62.0
	66.0				64.0m/3.8		3.7	3.2		66.0
	70.0						68.0m/3.5	2.8		70.0
	Reeves			2		2				Reeves

Note: Ratings according to EN13000.
Ratings shown in are determined by the strength of the boom or other structural components.
Refer to notes P21 and P22.

Unit: metric ton

Counterweight: 60.0 t
Carbody Weight: 20.0 t

45.7m Boom Length	45.7																
	21.3				27.4				33.5				39.6				
	88°	83°	65°	60°	88°	83°	65°	60°	88°	83°	65°	60°	88°	83°	65°	60°	
Working radius (m)	10.0	47.4															10.0
	12.0	43.8			41.2												12.0
	14.0	38.3			37.5			33.0									14.0
	16.0	33.9			33.2			32.2				26.6					16.0
	18.0	30.4	33.7		29.6			28.9				26.1					18.0
	20.0	27.5	29.5		26.7	29.2		26.1	28.7			25.5					20.0
	22.0	24.3	26.1		24.3	25.8		23.7	25.6			23.1					22.0
	24.0		23.4		21.4	23.1		21.3	22.9			21.1	22.8				24.0
	26.0		21.1		19.1	20.9		19.0	20.6			19.1	20.5				26.0
	28.0				17.1	19.0		17.1	18.7			17.1	18.7				28.0
	30.0					17.4		15.4	17.2			15.4	17.1				30.0
	34.0					32.0m/16.0		12.8	14.6			12.8	14.5				34.0
	38.0		10.3				40.0m/8.9		12.6			10.7	12.5				38.0
	42.0		40.0m/9.6	8.0			8.7						11.0				42.0
	46.0			44.0m/7.8			7.7	6.6				7.4		44.0m/10.2	48.0m/6.2		46.0
	50.0							6.2				6.5	5.4				50.0
	54.0											52.0m/6.2	5.1		5.5	4.3	54.0
	58.0												56.0m/4.8		4.9	4.2	58.0
	62.0															3.7	62.0
	Reeves		4			4			3				2				Reeves

45.7m Boom Length	45.7									
	45.7					51.8				
	88°	83°	65°	60°	88°	83°	65°	60°		
Working radius (m)	18.0	21.4						18.0		
	20.0	21.0			16.8			20.0		
	22.0	20.2			15.5			22.0		
	24.0	18.8			14.3			24.0		
	26.0	17.6	20.3		13.3			26.0		
	28.0	16.6	18.4		12.5	14.4		28.0		
	30.0	15.1	16.8		11.7	13.4		30.0		
	34.0	12.5	14.3		10.3	11.7		34.0		
	38.0	10.5	12.3		9.2	10.4		38.0		
	42.0	8.9	10.7		8.2	9.2		42.0		
	46.0	44.0m/8.2	9.2		5.6	8.2		46.0		
	50.0		7.9	52.0m/5.0	3.3	6.5		50.0		
	54.0			5.0		3.7	56.0m/4.3	54.0		
	58.0			4.5	3.3		56.0m/2.6	58.0		
	62.0			4.0	3.3		3.6	64.0m/2.8	62.0	
	66.0			64.0m/3.8	2.9		3.2	2.6	66.0	
	70.0				68.0m/2.7		2.8	2.2	70.0	
	74.0							72.0m/2.0	74.0	
	Reeves		2			2			Reeves	

Note: Ratings according to EN13000.

Ratings shown in are determined by the strength of the boom or other structural components.

Refer to notes P21 and P22.

Unit: metric ton

Counterweight: 60.0 t
Carbody Weight: 20.0 t

51.8m Boom Length	51.8																Boom length (m)
	21.3				27.4				33.5				39.6				Jib length (m)
	88°	83°	65°	60°	88°	83°	65°	60°	88°	83°	65°	60°	88°	83°	65°	60°	Boom angle
12.0	37.2				35.4												12.0
14.0	32.7				31.6				28.8								14.0
16.0	29.2				28.1				27.2				23.6				16.0
18.0	26.3	31.9			25.3				24.4				23.1				18.0
20.0	23.9	28.6			22.9	27.5			22.0				21.2				20.0
22.0	21.8	25.7			20.9	24.9			20.1	23.5			19.3				22.0
24.0	20.2	23.0			19.2	22.6			18.4	21.5			17.7	20.6			24.0
26.0		20.8			17.8	20.6			16.9	19.7			16.3	19.0			26.0
28.0		18.9			16.5	18.7			15.7	18.1			15.1	17.4			28.0
30.0						17.1			14.6	16.7			14.0	16.0			30.0
34.0						32.0m/15.8			12.7	14.4			12.2	13.8			34.0
38.0			9.2							12.5			10.7	12.0			38.0
42.0			8.3				44.0m/7.5						40.0m/10.0	10.6			42.0
46.0			44.0m/7.8	6.5			7.1					6.1		44.0m/10.0			46.0
50.0				48.0m/6.1			6.2	5.3				5.8	52.0m/4.1		52.0m/5.0		50.0
54.0								52.0m/5.0				5.1	4.1			4.8	54.0
58.0													3.8			4.3	58.0
62.0															60.0m/4.0	3.0	62.0
66.0																64.0m/2.8	66.0
Reeves			3				3					3			2		Reeves

51.8m Boom Length	51.8								Boom length (m)
	45.7				51.8				Jib length (m)
	88°	83°	65°	60°	88°	83°	65°	60°	Boom angle
18.0	19.2								18.0
20.0	18.9				15.7				20.0
22.0	18.5				15.5				22.0
24.0	17.0				14.4				24.0
26.0	15.6	18.0			13.4				26.0
28.0	14.3	16.6			12.5	14.8			28.0
30.0	13.3	15.3			11.7	13.7			30.0
34.0	11.5	13.1			10.4	12.0			34.0
38.0	10.0	11.3			9.2	10.6			38.0
42.0	8.8	9.9			8.2	9.2			42.0
46.0	44.0m/8.3	8.8			5.3	8.1			46.0
50.0		7.8			3.0	6.4			50.0
54.0			3.9			3.6			54.0
58.0			3.9			56.0m/2.4	3.3		58.0
62.0			3.4				3.0		62.0
66.0			3.0				2.6		66.0
70.0							2.2		70.0
74.0							72.0m/2.0		74.0
Reeves			2				2		Reeves

Note: Ratings according to EN13000.

Ratings shown in are determined by the strength of the boom or other structural components.

Refer to notes P21 and P22.

Unit: metric ton

Counterweight: 60.0 t
Carbody Weight: 20.0 t

54.9m Boom Length	54.9																Boom length (m)
	21.3				27.4				33.5				39.6				Jib length (m)
	88°	83°	65°	60°	88°	83°	65°	60°	88°	83°	65°	60°	88°	83°	65°	60°	Boom angle
12.0	33.7				32.6												12.0
14.0	29.8				28.8				26.9								14.0
16.0	26.7				25.6				24.7				22.2				16.0
18.0	24.1	29.6			23.1				22.1				21.2				18.0
20.0	21.9	26.5			21.0	24.9			20.0				19.2				20.0
22.0	20.2	24.0			19.2	22.7			18.2	21.5			17.5				22.0
24.0	18.7	21.9			17.6	20.6			16.7	19.7			16.0				24.0
26.0		20.1			16.3	18.9			15.4	18.0			14.7	17.3			26.0
28.0		18.6			15.2	17.5			14.3	16.6			13.6	15.8			28.0
30.0					14.2	16.2			13.3	15.3			12.6	14.6			30.0
34.0						32.0m/15.1			11.6	13.2			11.0	12.5			34.0
38.0			40.0m/8.1							11.6			9.7	10.9			38.0
42.0			8.0										40.0m/9.1	9.6			42.0
46.0			44.0m/7.5				6.6					48.0m/5.3		44.0m/9.1			46.0
50.0							5.9					5.3			52.0m/4.2		50.0
54.0												4.8			4.2		54.0
58.0												56.0m/4.5			3.9		58.0
62.0															3.4		62.0
Reeves		3				3				3				2			Reeves

54.9m Boom Length	54.9								Boom length (m)
	45.7				51.8				Jib length (m)
	88°	83°	65°	60°	88°	83°	65°	60°	Boom angle
18.0	18.2								18.0
20.0	17.9				14.9				20.0
22.0	16.7				14.6				22.0
24.0	15.2				14.3				24.0
26.0	14.0	16.2			13.2				26.0
28.0	12.9	15.0			12.1	14.0			28.0
30.0	11.9	13.8			11.2	13.0			30.0
34.0	10.3	11.8			9.6	11.0			34.0
38.0	9.0	10.2			8.3	9.4			38.0
42.0	7.9	8.9			7.2	8.2			42.0
46.0	44.0m/7.4	7.8			5.2	7.1			46.0
50.0		7.0			2.8	6.3			50.0
54.0			56.0m/3.2			3.5			54.0
58.0			3.2			56.0m/2.3	60.0m/2.9		58.0
62.0			3.1				2.7		62.0
66.0			2.7				2.3		66.0
70.0			68.0m/2.5						70.0
Reeves		2				2			Reeves

Note: Ratings according to EN13000.
Ratings shown in are determined by the strength of the boom or other structural components.
Refer to notes P21 and P22.



Luffing Boom Lifting Capacities With Luffing Jib

Attached at 23 Degree Boom to Luffing Jib Offset Angle

Unit: metric ton

Counterweight: 60.0 t
Carbody Weight: 20.0 t

21.3m Boom Length	Boom length (m)	21.3					
	Jib length (m)	21.3	27.4	33.5	39.6	45.7	51.8
	7.0	70.6	67.8	65.0	61.5	57.9	53.6
	8.0	70.6	67.8	65.0	61.5	57.9	53.6
	9.0	70.6	67.8	65.0	61.5	57.9	53.6
	10.0	66.0	63.7	61.4	58.5	55.7	52.3
	12.0	48.7	46.6	44.5	41.8	39.2	36.1
	14.0	37.8	35.8	33.8	31.3	28.9	25.9
	16.0	30.3	28.4	26.5	24.1	21.8	19.0
	18.0	24.7	22.8	21.0	18.7	16.6	13.9
	20.0	20.3	18.5	16.8	14.7	12.6	10.0
	21.0	18.5	16.7	15.1	12.9	10.9	8.4
	Reeves	6	6	5	5	5	5

27.4m Boom Length	Boom length (m)	27.4					
	Jib length (m)	21.3	27.4	33.5	39.6	45.7	51.8
	8.0	71.1	68.6	66.1	62.9	59.8	56.0
	9.0	71.1	68.6	66.1	62.9	59.8	56.0
	10.0	66.2	64.1	62.0	59.3	56.7	53.5
	12.0	48.9	47.0	45.0	42.6	40.2	37.3
	14.0	38.0	36.2	34.4	32.1	29.8	27.1
	16.0	30.5	28.7	27.0	24.8	22.7	20.2
	18.0	24.9	23.2	21.5	19.4	17.4	15.0
	20.0	20.5	18.9	17.3	15.3	13.4	11.0
	22.0	17.2	15.6	14.0	12.1	10.3	8.0
	24.0	14.4	12.9	11.4	9.5	7.7	5.5
	25.0	13.2	11.7	10.2	8.4	6.7	4.5
	Reeves	6	6	5	5	5	5

33.5m Boom Length	Boom length (m)	33.5					
	Jib length (m)	21.3	27.4	33.5	39.6	45.7	51.8
	9.0	71.5	69.3	67.2	64.4	61.7	58.4
	10.0	64.9	62.9	60.9	58.4	55.9	52.9
	12.0	49.0	47.1	45.3	43.0	40.8	38.0
	14.0	38.0	36.2	34.5	32.4	30.3	27.8
	16.0	30.4	28.7	27.1	25.0	23.1	20.7
	18.0	24.7	23.1	21.6	19.6	17.8	15.5
	20.0	20.5	18.9	17.4	15.5	13.8	11.6
	22.0	17.0	15.5	14.1	12.2	10.5	8.4
	24.0	14.2	12.8	11.4	9.6	7.9	5.9
	26.0	12.0	10.5	9.2	7.5	5.8	
	28.0	10.1	8.7	7.4	5.7	4.1	
	30.0	8.5	7.2	5.9	4.2		
	32.0	7.2	5.8	4.6			
	Reeves	6	6	6	5	5	5

39.6m Boom Length	Boom length (m)	39.6					
	Jib length (m)	21.3	27.4	33.5	39.6	45.7	51.8
	10.0	61.4	59.5	57.5	55.1	52.8	49.9
	12.0	48.7	46.9	45.1	42.9	40.8	38.2
	14.0	37.9	36.2	34.6	32.5	30.5	28.1
	16.0	30.2	28.6	27.1	25.2	23.3	21.0
	18.0	24.6	23.1	21.6	19.7	18.0	15.8
	20.0	20.2	18.8	17.3	15.6	13.9	11.8
	22.0	16.8	15.3	14.0	12.2	10.6	8.6
	24.0	14.0	12.6	11.3	9.6	8.0	6.1
	26.0	11.8	10.4	9.1	7.4	5.9	4.0
	28.0	9.9	8.5	7.3	5.7	4.2	
	30.0	8.3	7.0	5.7	4.2		
	32.0	6.9	5.6	4.4			
	35.0	5.2	3.9				
	36.0	4.7					
	37.0	4.2					
	Reeves	5	5	5	5	4	4

45.7m Boom Length	Boom length (m)	45.7					
	Jib length (m)	21.3	27.4	33.5	39.6	45.7	51.8
	11.0	51.9	50.1	48.3	46.1	43.9	41.3
	12.0	46.6	44.8	43.2	41.0	39.0	36.4
	14.0	37.7	36.1	34.5	32.5	30.6	28.3
	16.0	30.1	28.5	27.0	25.2	23.4	21.2
	18.0	24.4	22.9	21.5	19.7	18.0	16.0
	20.0	20.1	18.6	17.3	15.6	13.9	11.9
	22.0	16.6	15.2	13.9	12.2	10.7	8.8
	24.0	13.8	12.5	11.2	9.6	8.1	6.2
	26.0	11.6	10.2	9.0	7.4	6.0	4.1
	28.0	9.7	8.4	7.2	5.6	4.2	
	30.0	8.0	6.7	5.5	4.0		
	32.0	6.6	5.4	4.2			
	34.0	5.4	4.2				
	36.0	4.4					
	37.0	3.9					
	Reeves	4	4	4	4	4	4

51.8m Boom Length	Boom length (m)	51.8					
	Jib length (m)	21.3	27.4	33.5	39.6	45.7	51.8
	12.0	44.5	42.8	41.1	39.0	37.0	34.6
	14.0	36.4	34.8	33.3	31.3	29.5	27.2
	16.0	29.7	28.2	26.8	25.0	23.3	21.1
	18.0	24.1	22.7	21.3	19.6	17.9	15.9
	20.0	19.7	18.3	17.0	15.4	13.8	11.9
	22.0	16.3	14.9	13.7	12.1	10.6	8.7
	24.0	13.5	12.2	11.0	9.4	8.0	6.2
	26.0	11.2	10.0	8.8	7.2	5.8	4.1
	28.0	9.4	8.1	6.9	5.4	4.1	
	30.0	7.7	6.4	5.3	3.8		
	32.0	6.3	5.1	4.0			
	34.0	5.1	3.9				
	36.0	4.0					
	Reeves	4	4	4	3	3	3

54.9m Boom Length	Boom length (m)	54.9					
	Jib length (m)	21.3	27.4	33.5	39.6	45.7	51.8
	13.0	39.3	37.7	36.2	34.2	32.3	30.0
	14.0	35.6	34.0	32.5	30.6	28.8	26.6
	16.0	29.4	27.9	26.5	24.7	23.0	20.9
	18.0	23.9	22.5	21.2	19.5	17.8	15.9
	20.0	19.6	18.2	16.9	15.3	13.7	11.8
	22.0	16.1	14.8	13.5	12.0	10.5	8.6
	24.0	13.3	12.0	10.8	9.3	7.9	6.1
	26.0	11.1	9.8	8.6	7.1	5.7	4.0
	28.0	9.1	7.9	6.7	5.2	3.9	
	30.0	7.5	6.3	5.2	3.7		
	32.0	6.1	4.9	3.8			
	34.0	4.9	3.7				
	35.0	4.3					
	Reeves	3	3	3	3	3	3

Note: Ratings according to EN13000.

Ratings shown in are determined by the strength of the boom or other structural components.

Refer to notes P21 and P22.

PARTS AND ATTACHMENTS

Base Machine

Including 3rd winch, Translifter, Low boom, Main wire, Boom wire
Weight: 43,820 kg

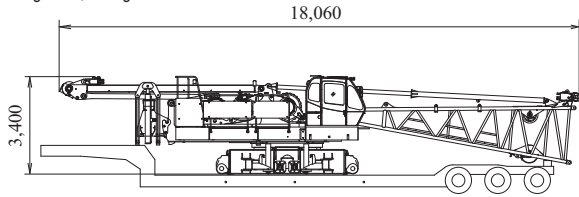

Base Machine

Including 3rd winch, Translifter, Main wire, Boom wire
Weight: 39,300 kg

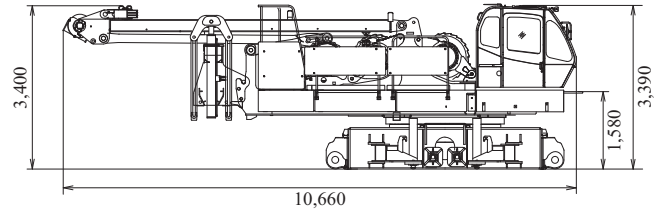

Crawler

Weight: 18,000 kg

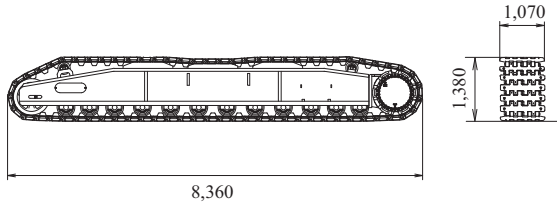

Gantry

Weight: 2,950 kg

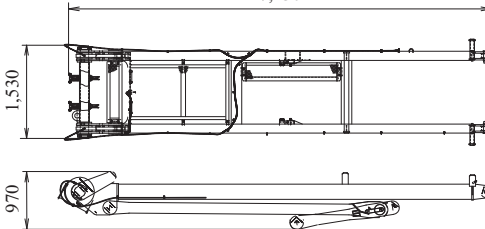

Translifter

Weight: 360 kg

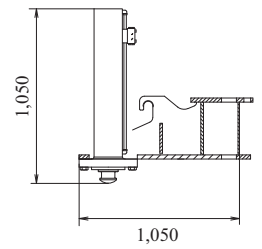

Counterweight A

Weight: 10,000 kg

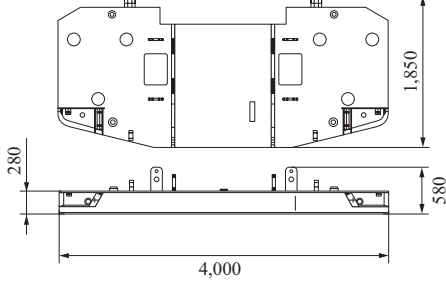

Counterweight B

Weight: 5,000 kg x 10 pieces

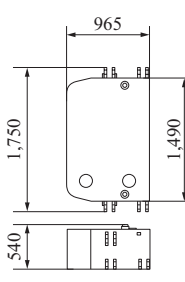

Carbody Weight A

Weight: 5,000 kg x 2 pieces

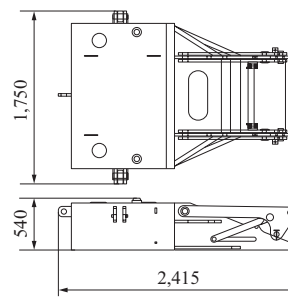

Carbody Weight B

Weight: 5,000 kg x 2 pieces

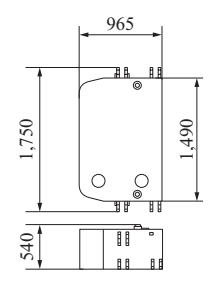

Boom Base

Weight: 2,620 kg

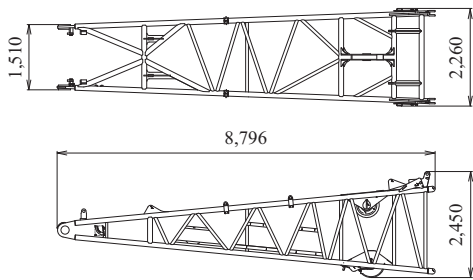

Taper Insert Boom

Weight: 710 kg

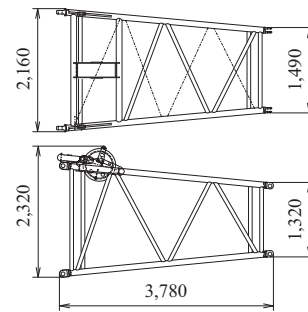

Boom Tip

Weight: 2,100 kg

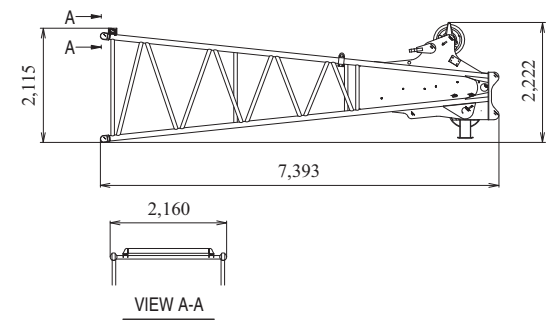

Heavy Boom Tip

Weight: 2,580 kg

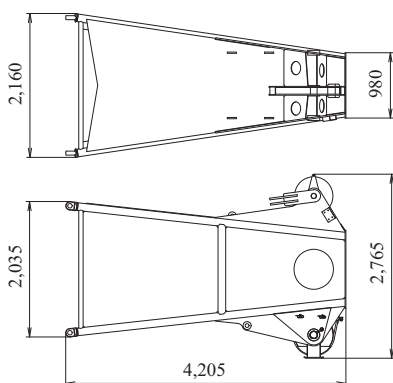

3.0 m Insert Boom

Weight: 530 kg

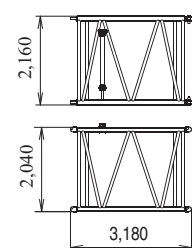

6.1 m Insert Boom

Weight: 880 kg

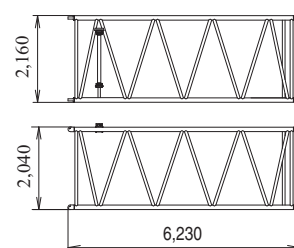

9.1 m Insert Boom

Weight: 1,220 kg

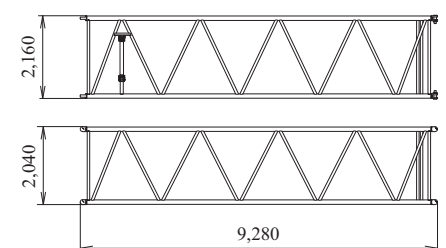

12.2 m Insert Boom

Weight: 1,450 kg

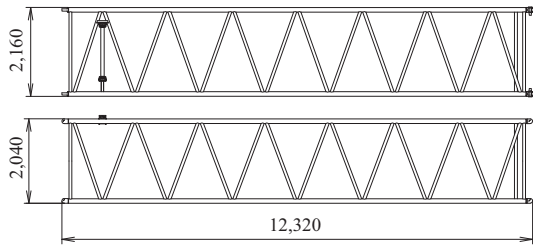

Backstop for Crane Boom (2 pieces)

Weight: 665 kg / Left Side

Weight: 655 kg / Right Side

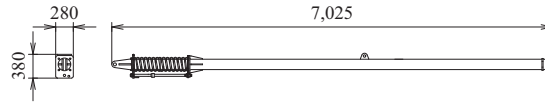

Backstop for Crane and Luffing Boom (2 pieces)

Weight: 740 kg / 1 piece

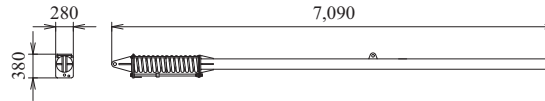

Jib Base (for Crane)

Weight: 210 kg

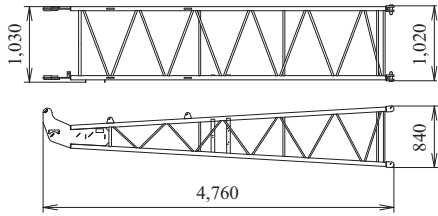

Jib Tip (for Crane)

Weight: 315 kg

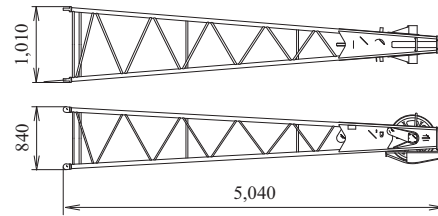

Jib Strut

Weight: 300 kg

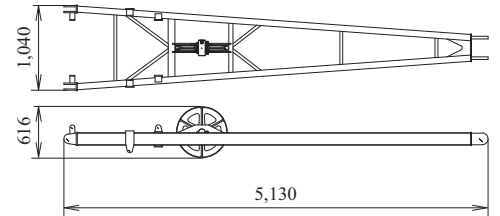

3.0 m (Insert Jib)

Weight: 110 kg

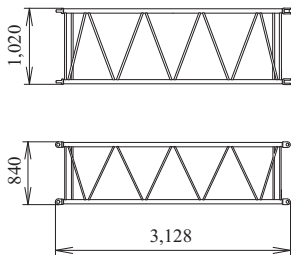

6.1 m (Insert Jib)

Weight: 190 kg

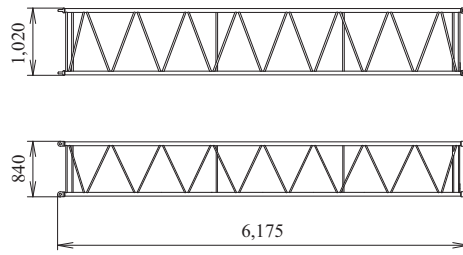

3.0 m Insert Jib

Weight: 310 kg

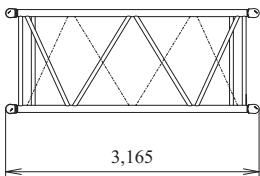

6.1 m Insert Jib

Weight: 540 kg

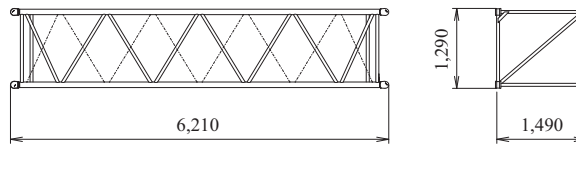

9.1 m Insert Jib (Long Insert Boom)

Weight: 740 kg

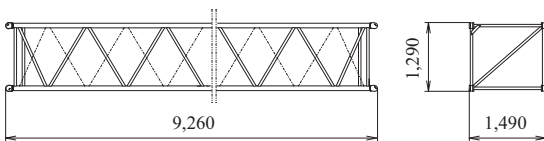

12.2 m Insert Jib

Weight: 960 kg

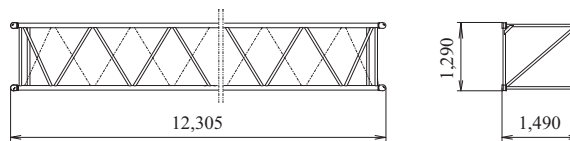

PARTS AND ATTACHMENTS

Luffing Upper Boom

Weight: 2,545 kg

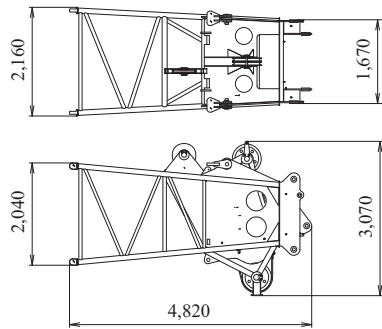

Luffing Jib Base

Weight: 1,140 kg

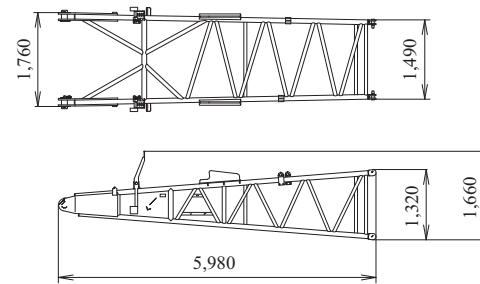

Luffing Jib Tip

Weight: 1,170 kg

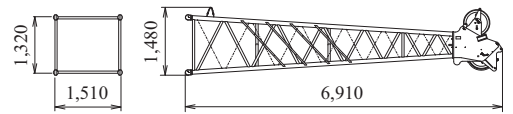

Luffing Jib Backstop

Weight: 100 kg / 1 piece

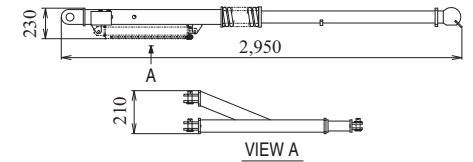

Front Strut (Luffing Jib)

Weight: 1,000 kg

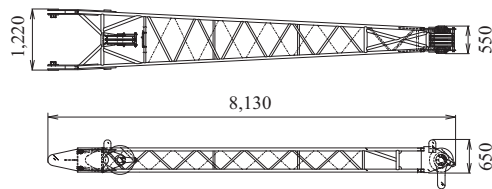

Rear Strut (Luffing Jib)

Weight: 1,090 kg

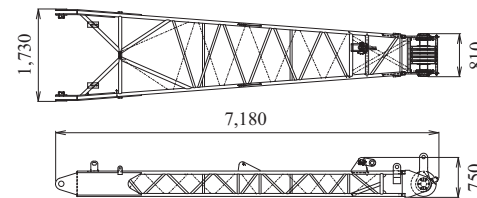

Strut Backstop (Luffing Jib)

Weight: 180 kg / 1 piece

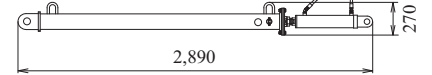

Aux. Sheave

Weight: 300 kg

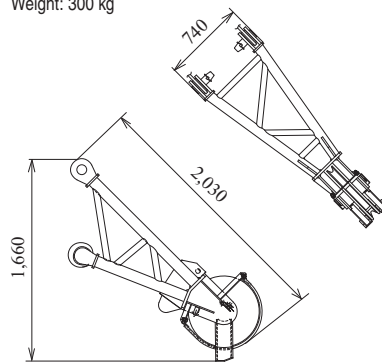

Aux. Sheave (for Luffing Jib)

Weight: 380 kg

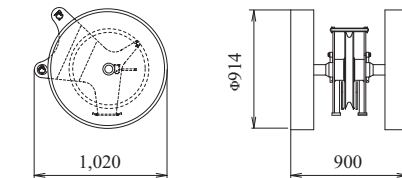

Upper Spreader

Weight: 590 kg

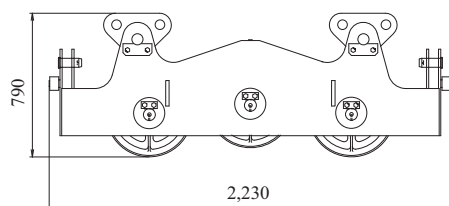

Lower Spreader

Weight: 400 kg

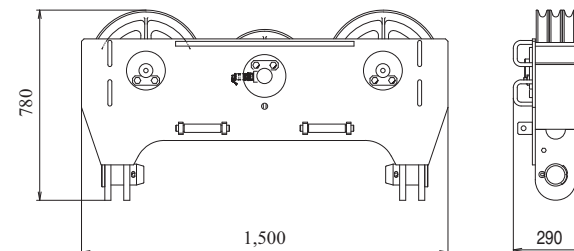

Luffing Boom Tip Assembly

Weight: 6,600 kg

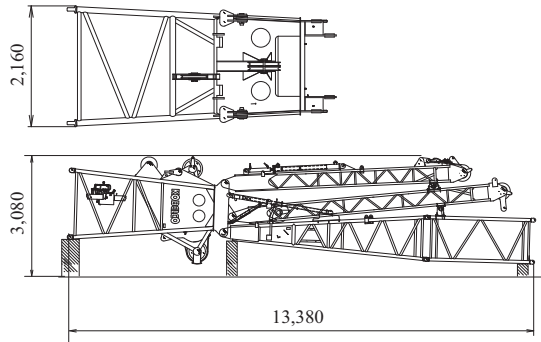

Luffing Jib Drum

Weight: 1,470 kg

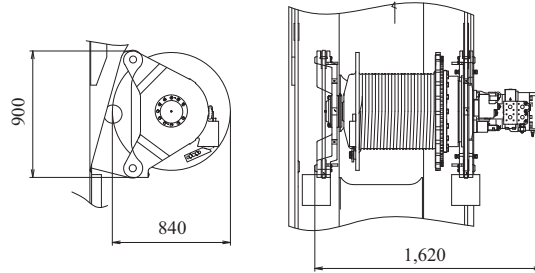

Ball Hook

Weight: 460 kg

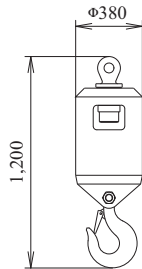

35 t Hook Block

Weight: 900 kg

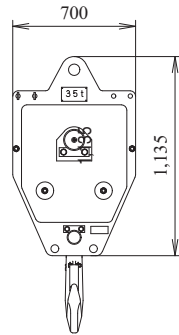
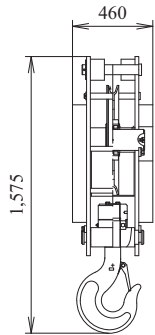

70 t Hook Block

Weight: 1,200 kg

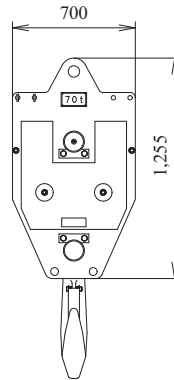
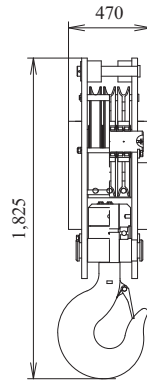

110 t Hook Block

Weight: 1,730 kg

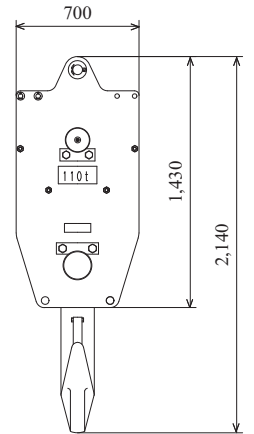
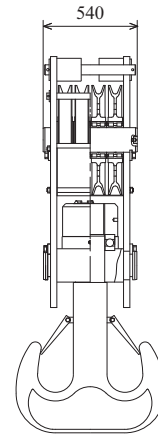

160 t Hook Block

Weight: 2,800 kg

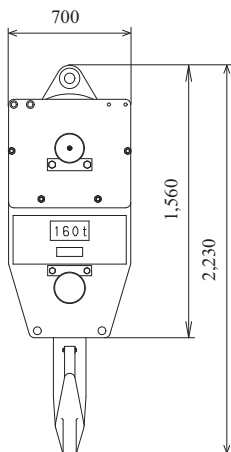
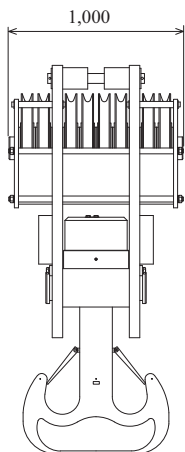

180 t Hook Block

Weight: 2,800 kg

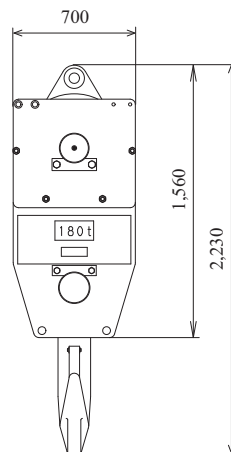
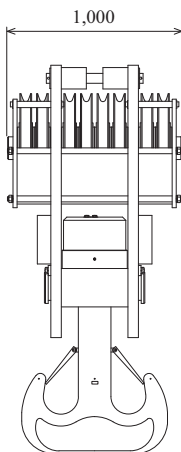

TRANSPORTATION PLAN

Luffing Boom 54.9 m + Luffing Jib 51.8 m

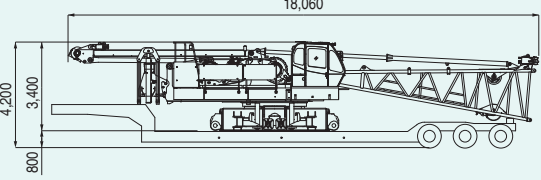
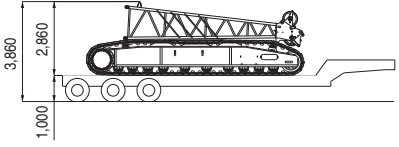
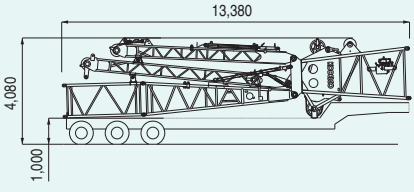
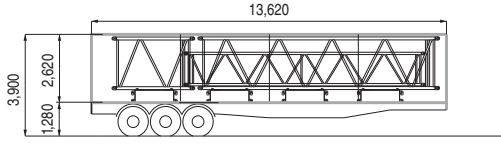
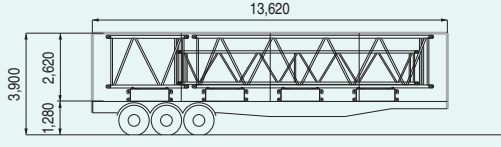
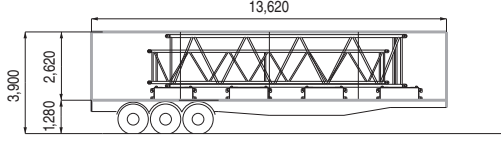
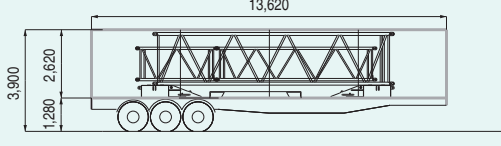
Configuration	Description	Total Weight
No.1 Low Loader Width: 3,500 mm 	Base Machine = Including 3rd winch Translifter Low Boom Main Wire Boom Wire	43.82 t
No.2 Semi Loader 	Crawler No.1 = Crawler No.2 = Luffing Jib Tip = Total =	18.00 t 18.00 t 1.17 t <hr/> 37.17 t
No.3 Semi Loader 	Luffing boom tip assembly	6.60 t
No.4 Tent Side Truck 	Counterweight No.2 (4 x 5.00 ton) = 9.1 m Insert Boom x 1 = 9.1 m Luffing Insert Jib x 1 = 3.0 m Insert Boom x 1 = Total =	20.00 t 1.22 t 0.74 t 0.63 t <hr/> 22.59 t
No.5 Tent Side Truck 	Counterweight No.2 (4 x 5.00 ton) = 9.1 m Insert Boom x 1 = 9.1 m Luffing Insert Jib x 1 = 3.0 m Insert Boom x 1 = Total =	20.00 t 1.42 t 0.74 t 0.53 t <hr/> 22.69 t
No.6 Tent Side Truck 	Counterweight No.2 (2 x 5.00 ton) Carbody Weight No.2 (2 x 5.00 ton) = 9.1 m Insert Boom x 1 = 9.1 m Luffing Insert Jib x 1 = Total =	10.00 t 10.00 t 1.42 t 0.74 t <hr/> 22.16 t
No.7 Tent Side Truck 	Counterweight No.1 Base = 9.1 m Insert Boom x 1 = 6.1 m Luffing Insert Jib x 1 = 3.0 m Luffing Insert Jib x 1 = Carbody Weight No.1 (2 x 5.07 ton) = Total =	10.00 t 1.22 t 0.54 t 0.31 t 10.14 t <hr/> 22.21 t

Note: Estimated weights may vary $\pm 2\%$.

This transport plan depends on specifications of your trailers/trucks and the areas or countries where you transport.

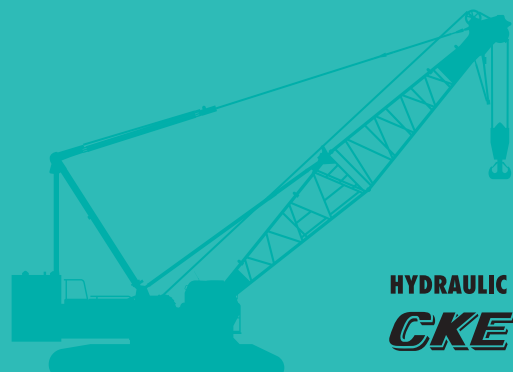

HYDRAULIC CRAWLER CRANE **CKE1800**

Standard Equipment

Upper structure/Lower structure

Counterweight: 60.0 ton (total weight)
Carbody weight: 20.0 ton (total weight)
1,070 mm shoe crawlers
Batteries (170 Ah/20 HR)
Trans-lifter (jack system)
Gantry raising/lowering cylinder
Electric hand throttle grip
Variable boom hoist speed controller
Swing neutral-free/brake select switch
Side deck for cab
Side deck (right side guard)
Steps (crawlers)
Two front working lights
Tools (for routine maintenance)
Two rear view mirrors
Electric fuel pump
Counterweight self removal
Crawler self removal
Cable roller (for boom)

Cab/Control

Boom hoist pedal
Air conditioner
Cup holder
Ashtray
Cigar lighter
Intermittent wiper & window washer (skylight and front window)
Sun visor
Roof blind
Floor mat (cloth)
Foot rest
Shoe tray
Level gauge (operator cabin)

Safety Device

Load Moment Indicator (with boom lowering slow stop function)
LMI release key (for hook over-hoist prevention device and boom over-hoist prevention device)
LCD multi display
Ultimate stop function for boom over-hoist
Function lock lever
Propel lever lock
Mechanical drum lock pawl (main, aux. and boom hoist)
Signal horn
Swing parking brake
Mechanical swing lock pin (four positions)
Swing flashers/warning buzzer
Cab window guard (left side)
Cab top guard
Fire extinguisher
External lamp for over-load alarm
Life hammer

Note: Standard equipment may vary depending on your areas or countries.

Due to our policy of continual product improvements all designs and specifications are subject to change without advance notice.

Copyright by KOBELCO CONSTRUCTION MACHINERY CO., LTD. No part of this catalog may be reproduced in any manner without notice.

KOBELCO CONSTRUCTION MACHINERY CO., LTD.

5-15, Kitashinagawa 5-chome, Shinagawa-ku, Tokyo 141-8626 JAPAN

Tel: +81-3-5789-2121 Fax: +81-3-5789-3372

URL: <https://www.kobelcocm-global.com>

KOBELCO is the corporate mark used by Kobe Steel on a variety of products and in the names of a number of Kobe Steel Group companies.

Inquiries To: