

Hydraulic Crawler Crane

**CKE**

EU Stage V  
Engine

**1100G**

Model : CKE1100G-3

Max. Lifting Capacity : **110 t x 3.6 m \***

Max. Crane Boom Length : **70.1 m**

Max. Fixed Jib Combination : **61.0 m + 21.3 m**

\* Auxiliary sheave is necessary.

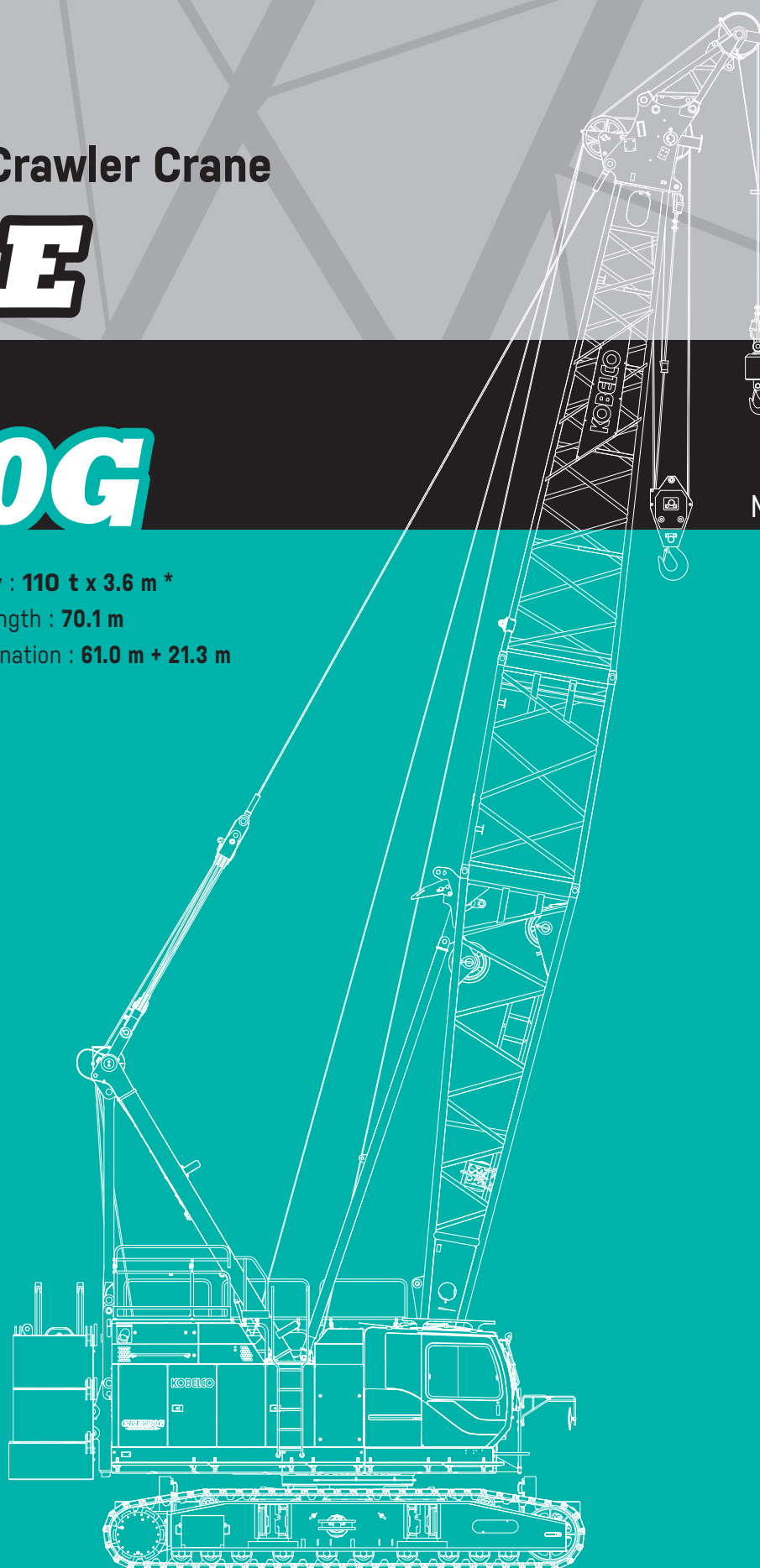

**KOBELCO**

# CONFIGURATION

## Crane Boom

Max. Lifting Capacity:  
110 metric ton x 3.6 m\*  
Max. Boom Length:  
70.1 m



\* Auxiliary sheave is must.

## Fixed Jib

Max. Lifting Capacity:  
10.9 metric ton x 22.0 m  
Max. Combination:  
61.0 m + 21.3 m

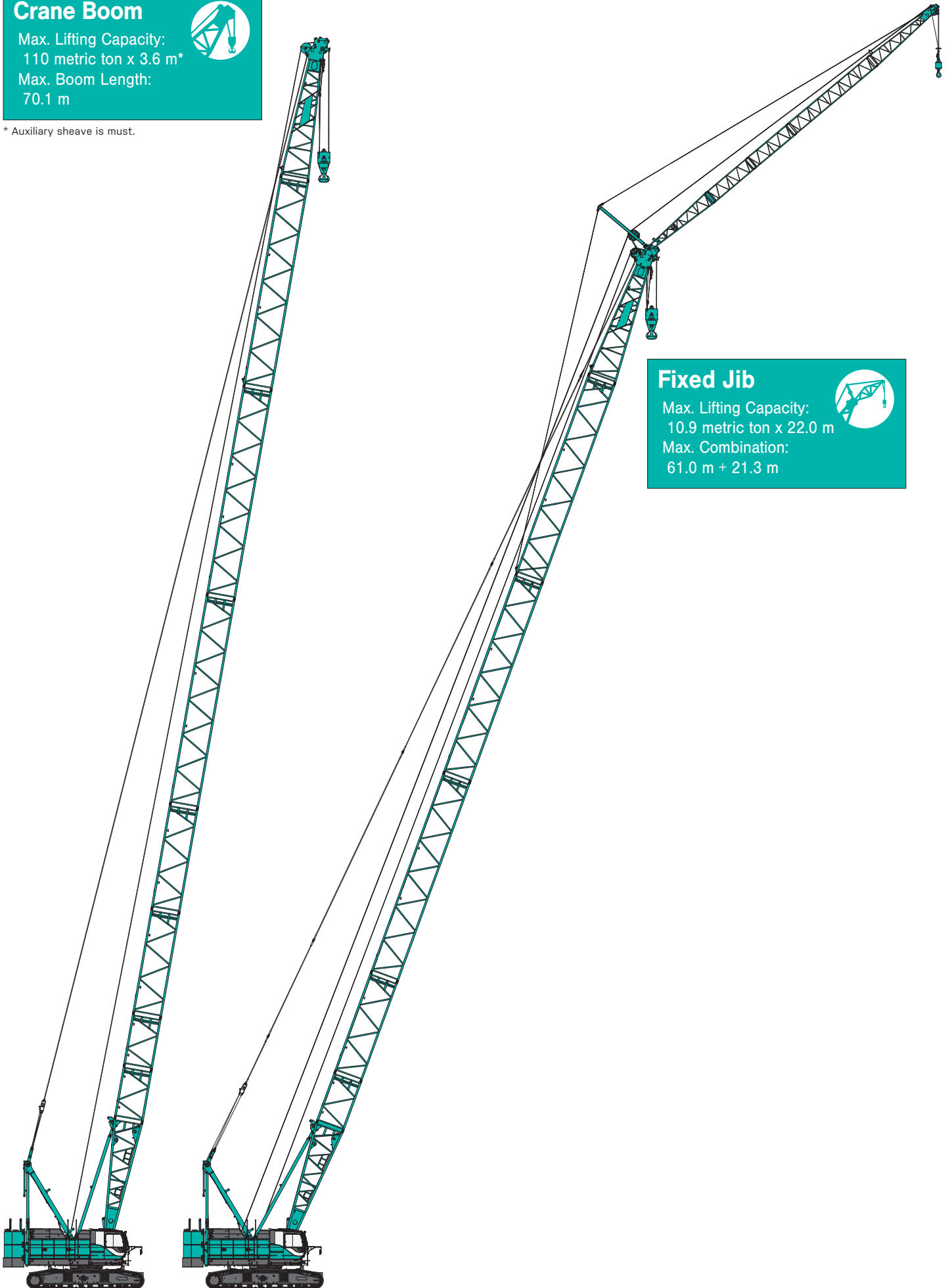

# **CKE1100G-3**

## **CONTENTS**

<b>1</b>	<b>CONFIGURATION</b>
<b>3</b>	<b>SPECIFICATIONS</b>
<b>5</b>	<b>GENERAL DIMENSIONS</b>
<b>6</b>	<b>BOOM AND JIB ARRANGEMENTS</b>
<b>7</b>	<b>WORKING RANGES</b>
<b>10</b>	<b>SUPPLEMENTAL DATA</b>
<b>11</b>	<b>LIFTING CAPACITIES</b>
<b>16</b>	<b>SUPPLEMENTAL DATA FOR CLAMSHELL</b>
<b>17</b>	<b>LIFTING CAPACITIES</b>
<b>18</b>	<b>SUPPLEMENTAL DATA FOR REDUCED WEIGHTS</b>
<b>19</b>	<b>LIFTING CAPACITIES</b>
<b>20</b>	<b>TRANSPORTATION PLAN</b>
<b>21</b>	<b>PARTS AND ATTACHMENTS</b>

# SPECIFICATIONS



## Power Plant

**Model:** HINO J08E-YD

**Type:** 4 cycle, water-cooled, vertical in-line 6, direct injection, turbo-charger, intercooled

Complies with NRMM (Europe) Stage V

**Displacement:** 7.684 L

**Rated power:** 213 kW/2,100 min<sup>-1</sup>

**Max. Torque:** 1,017 N·m/1,600 min<sup>-1</sup>

**Cooling System:** Water-cooled

**Starter:** 24V-5kW

**Radiator:** Corrugated type core, thermostatically controlled

**Air cleaner:** Dry type with replaceable paper element

**Throttle:** Electrically controlled, in conjunction with floor mounted pedal

**Fuel filter:** Replaceable paper element

**Batteries:** Two 12V x 136 Ah/5HR capacity, series connected

**Fuel tank capacity:** 400 L

**AdBlue® tank usable volume:** 30 L



## Hydraulic System

**Main pumps:** 4 variable displacement piston pumps

**Control:** Full-flow hydraulic control system for infinitely variable pressure to all winches, propel and swing. Controls respond instantly to the touch, delivering smooth function operation.

**Cooling:** Oil-to-air heat exchanger (plate-fin type)

**Filtration:** Full-flow and bypass type with replaceable element

**Max. relief valve pressure:**

**Load hoist, boom hoist and propel system:** 31.9 MPa

**Swing system:** 27.5 MPa

**Control system:** 5.4 MPa

**Oil Quantity (at the reference level):** 455 L



## Boom Hoisting System

Powered by a hydraulic motor through a planetary reducer.

**Brake:** A spring-set, hydraulically released multiple-disc brake is mounted on the boom hoist motor and operated through a counter-balance valve.

**Drum Lock:** External ratchet for locking drum

**Drum:** Single drum, grooved for 20 mm dia. wire rope

**Line Speed:** Single line on first drum layer

**Hoisting/Lowering:** 48 to 2 m/min

**Boom hoisting/lowering:** 20mm x 155 m

**Boom guy line:** 34 mm

**Boom backstops:** Required for all boom length



## Load Hoisting System

Front and rear drums for load hoist powered by hydraulic variable plunger motors, driven through planetary reducers.

**Negative Brake:** A spring-set, hydraulically released multiple-disc brake is mounted on the hoist motor and operated through a counter-balance valve. (Positive free fall brake is optional)

**Drum Lock:** External ratchet for locking drum

**Drum:**

**Front Drum:**

614 mm P.C.D x 617 mm wide drum, grooved for 26 mm wire rope. Rope capacity is 265 m working length and 360 m storage length.

**Rear Drum:** 614 mm P.C.D x 617 mm wide drum, grooved for 26 mm wire rope. Rope capacity is 235 m working length and 360 m storage length.

**Diameter of wire rope**

**Main winch:** 26 mm x 265 m

**Aux. winch:** 26 mm x 235 m

**Line Speed\*:**

**Hoisting/lowering:** 120 to 3 m/min

**Line Pull:**

**Max. Line Pull\*\*:** 208 kN {21.2 tf}

(Referential performance)

**Rated Line Pull:** 108 kN {11.0 tf}

\*Single line on first drum layer

\*\*Max. line pull is not based on wire rope strength



## Swing System

Swing unit is powered by hydraulic motor driving spur gears through planetary reducer, the swing system provides 360° rotation.

**Swing parking brakes:** A spring-set, hydraulically released multiple-disc brake is mounted on swing motor.

**Swing circle:** Single-row ball bearing with an integral internally cut swing gear.

**Swing lock:** Manually, four position lock for transportation

**Swing Speed:** 3.2 min<sup>-1</sup>



## Upper Structure

Torsion-free precision machined upper frame. All components are located clearly and service friendly. Engine will with low noise level.

**Counterweight:** 34.6 ton



## Cab & Control

Totally enclosed, full vision cab with safety glass, fully adjustable, high backed seat with a headrest and armrests, and intermittent wiper and window washer (skylight and front window).

**Cab fittings:**

Air conditioner, convenient compartment (for tool), cup holder, cigarette lighter, sun visor, roof blind, tinted glass, floor mat, footrest, and shoe tray



## Lower Structure

Steel-welded carbody with axles. Crawler assemblies can be hydraulically extended for wide-track operation or retracted for transportation. Crawler belt tension is maintained by hydraulic jack force on the track-adjusting bearing block.

**Carbody weight:** 6.5 ton

**Crawler drive:** Independent hydraulic propel drive is built into each crawler side frame. Each drive consists of a hydraulic motor propelling a driving tumbler through a planetary gear box. Hydraulic motor and gear box are built into the crawler side frame within the shoe width.

**Crawler brakes:** Spring-set, hydraulically released parking brakes are built into each propel drive.

**Steering mechanism:** A hydraulic propel system provides both skid steering (driving one track only) and counter-rotating steering (driving each track in opposite directions).

**Track rollers:** Sealed track rollers for maintenance-free operation.

**Shoe (flat):** 900 mm wide each crawler

**Max. gradeability:** 40%



## Weight

Including upper and lower machine, 34.6 ton counterweight and 6.5 ton carbody weight, basic boom (or basic boom + basic jib), hook, and other accessories.

**Weight:** 102.1 ton

**Ground pressure:** 95.9 kPa



## Attachment

### Boom & Jib:

Welded lattice construction using tubular, high-tensile steel chords with pin connection between sections.

### Boom and Jib length

	Min. Length (Min. combination)	Max. Length (Max. combination)
Crane Boom	15.2 m	70.1 m
Fixed jib	27.4 m + 9.1 m	61.0 m + 21.3 m

## Main Specifications (Model: CKE1100G-3)

Crane Boom	
Max. Lifting Capacity	110 t x 3.6 m * <sup>3</sup>
Max. Length	70.1 m
Fixed Jib	
Max. Lifting Capacity	10.9 t x 22.0 m
Max. Combination	61.0 m + 21.3 m
Main & Aux. Winch	
Max. Line Speed (1st layer)	120 m/min
Rated Line Pull (Single line)	108 kN {11.0 tf}
Wire Rope Diameter	26 mm
Wire Rope Length	265m (Main), 235 m (Aux.)
Brake Type (Free fall)	Wet-type multiple disc brake (Optional)
Working Speed	
Swing Speed	3.2 min <sup>-1</sup> {rpm}
Travel Speed	1.4/1.0 km/h
Power Plant	
Model	HINO J08E-YD
Engine Output	213 kW/2,100min <sup>-1</sup>
Fuel Tank	400 L
AdBlue® Tank Usable Volume	30 L

Hydraulic System	
Main Pumps	4 variable displacement
Max. Pressure	31.9 MPa {325 kg/cm <sup>2</sup> }
Oil Quantity (at the reference level)	455 L
Self-Removal Device	
	counterweight/crawler self-removal device
Weight	
Operating Weight	102.1 t * <sup>1</sup>
Ground Pressure	95.9 kPa
Counterweight	34,600 kg
Transport Weight	59,305 kg * <sup>2</sup>

Units are SI units. { } indicates conventional units.

Line speeds in table are for light loads. Line speed varies with load.

\*<sup>1</sup> Including upper and lower machine, 34.6 ton counterweight, 6.5 ton carbody weight, basic boom, hook, and other accessories.

\*<sup>2</sup> Base machine with boom base, gantry, crawlers, and wire ropes (front/rear/boom drum)

\*<sup>3</sup> Auxiliary sheave is necessary.

# GENERAL DIMENSIONS

(Unit: mm)

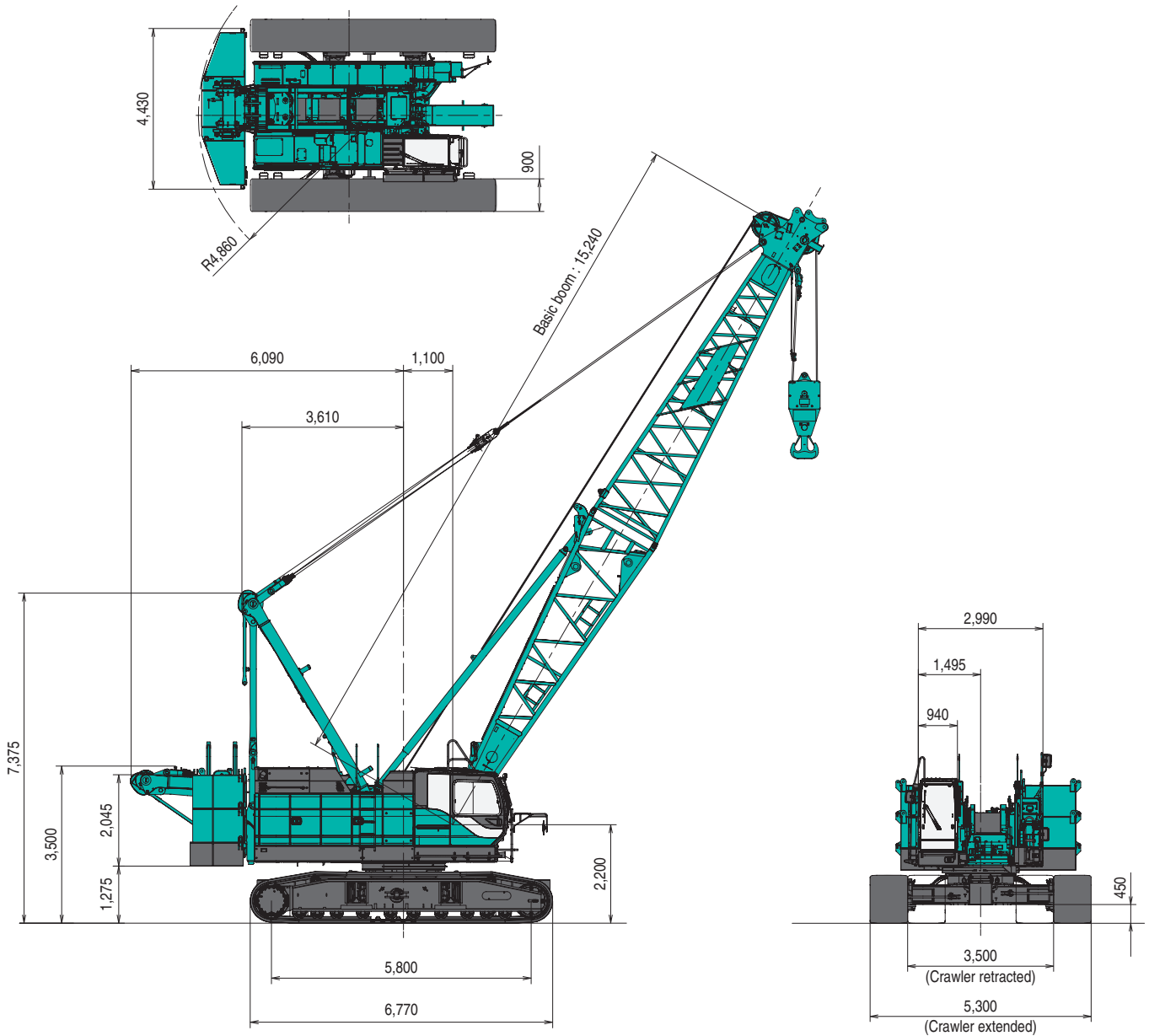

This catalog may contain photographs of machines with specifications, attachments and optional equipment.

## Limit of Hook Lifting

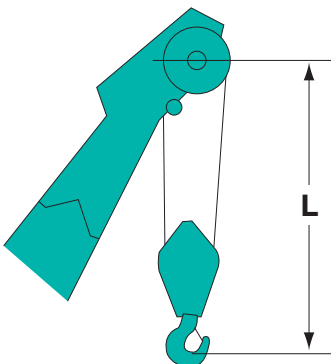

Hook	L
110 t hook	4.2 m
70 t hook	4.1 m
35 t hook	3.9 m

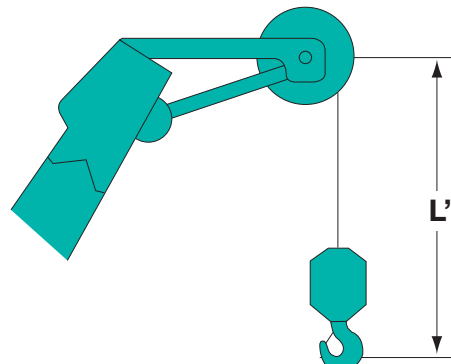

Hook	L'
Ball hook	3.6 m
35 t hook	3.9 m

# BOOM AND JIB ARRANGEMENTS

## Crane Boom Arrangements

Boom length m (ft)	Boom arrangement
15.2 (50)	
18.3 (60)	※
21.3 (70)	※
24.4 (80)	※
27.4 (90)	※
30.5 (100)	※
33.5 (110)	※
36.6 (120)	※
39.6 (130)	※
42.7 (140)	※
45.7 (150)	※

Boom length m (ft)	Boom arrangement
48.8 (160)	※
51.8 (170)	※
54.9 (180)	※
57.9 (190)	※
61.0 (200)	※
64.0 (210)	※
67.1 (220)	※
70.1 (230)	※

Symbol	Boom Length	Remarks
	7.6 m	Boom Base
	7.6 m	Boom Tip
	3.0 m	Boom Insert
	6.1 m	Boom Insert
	12.2 m	Boom Insert
	12.2 m	Boom Insert (with lug)

- ↗ mark shows the boom insert with lug attached and the guy line installing position when the fixed jib is used.
- ※ mark shows the standard boom arrangement which make the boom arrangement of less than the each boom length possible.
- mark shows the installing of the cable roller for the boom insert.

## Fixed Jib Arrangements

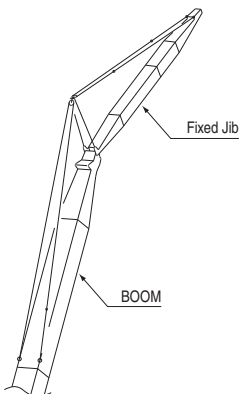

Crane boom length	Jib length m (ft)	Jib arrangement
27.4 m to 61.0 m	9.1 (30)	
	12.2 (40)	
	15.2 (50)	
	18.3 (60)	
	21.3 (70)	

Symbol	Jib Length	Remarks
	4.6 m	Jib Base
	4.6 m	Jib Tip
	3.0 m	Jib Insert
	6.1 m	Jib Insert

# WORKING RANGES

## Crane Boom

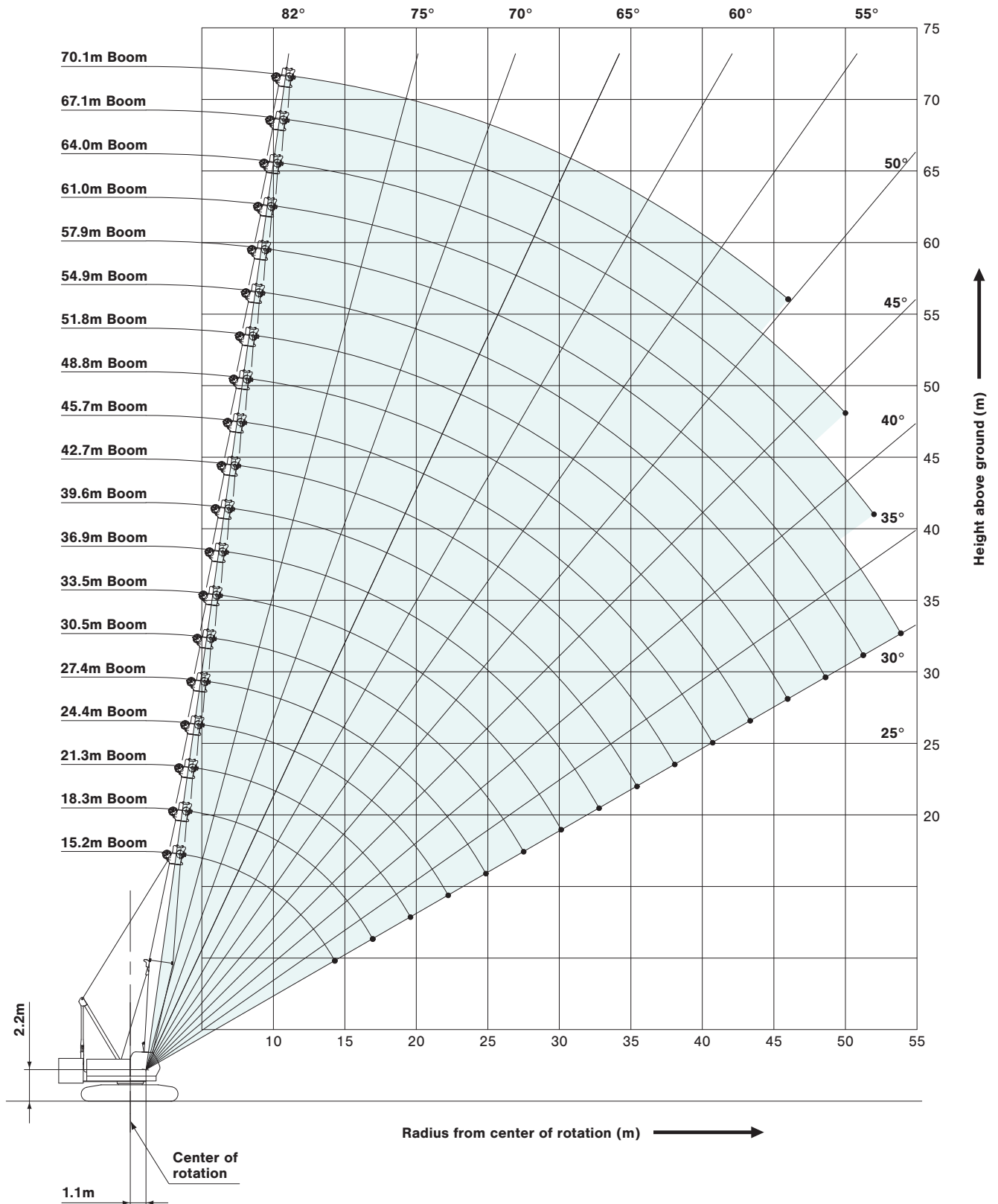



# Fixed Jib 10°

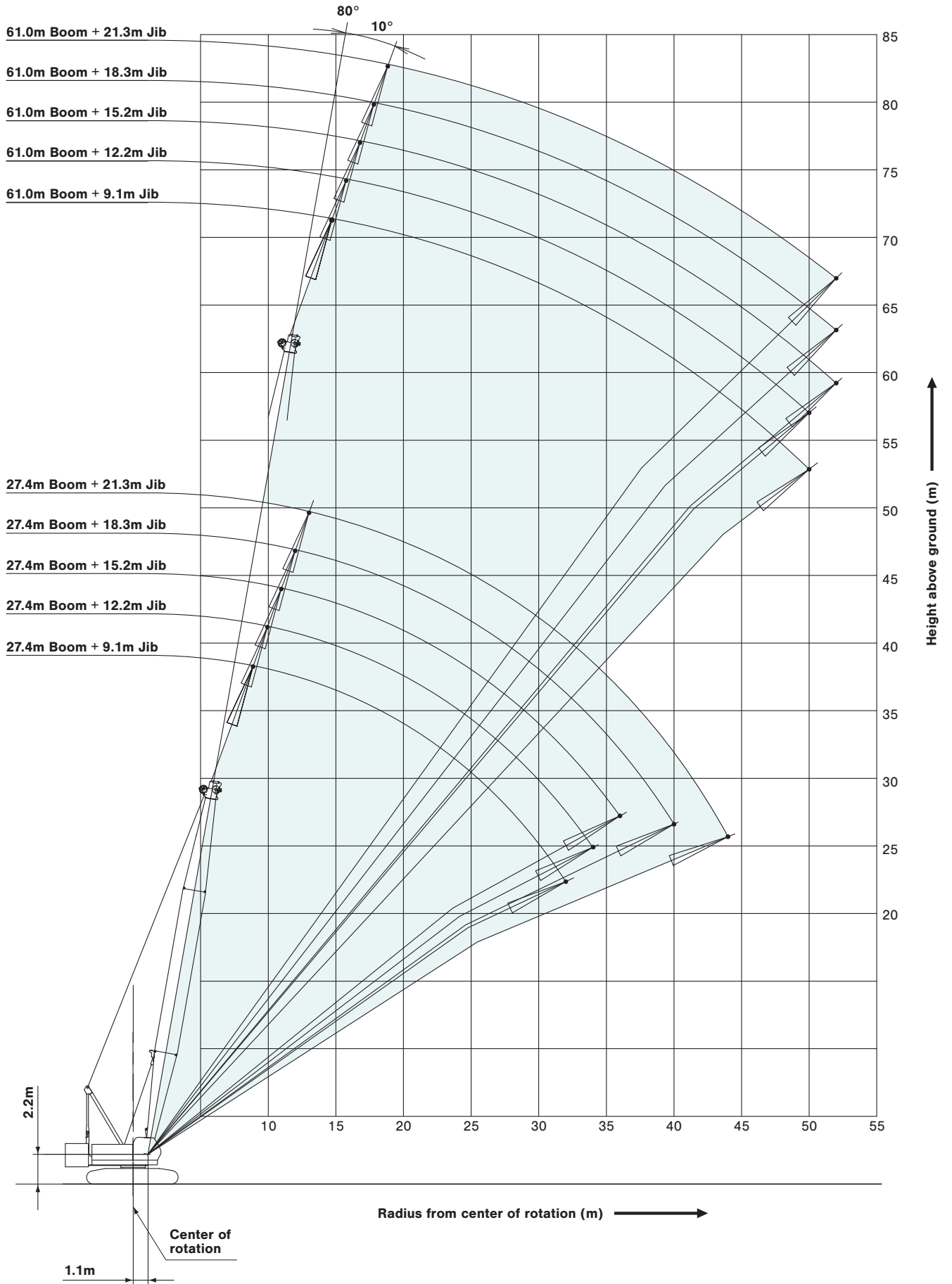

# WORKING RANGES

## Fixed Jib 30°

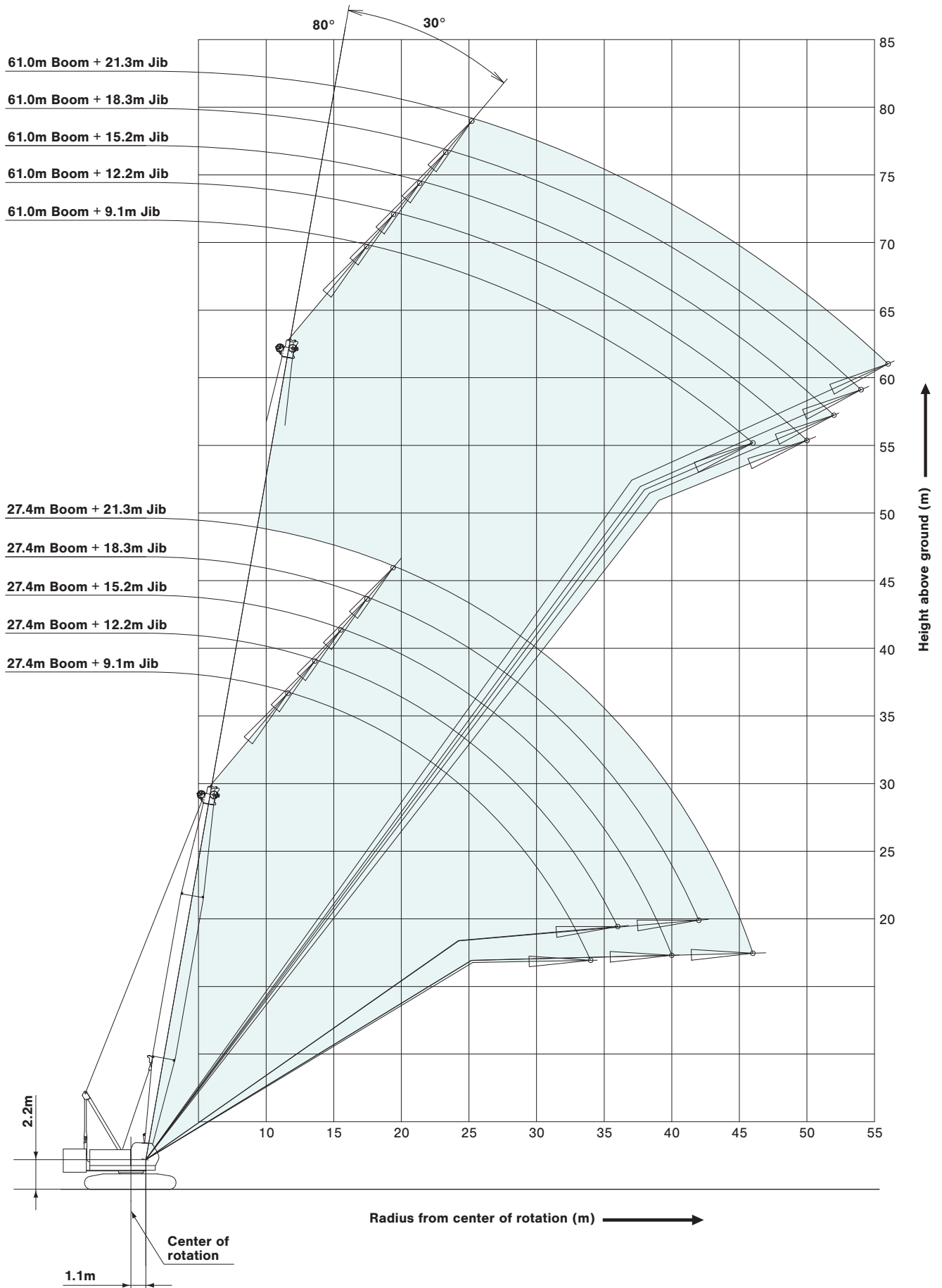

# SUPPLEMENTAL DATA

- Ratings are calculated to comply with EN13000, ISO 4305 and include factors based on a 4 degree tipping angle.
- Operating radius is the horizontal distance from centerline of rotation to a vertical line through the center of gravity of the load.
- The weight of hook block, slings, and all other load handling accessories shall be considered part of the lifted load.
- Ratings shown are based on freely suspended loads and make no allowance for such factors as wind effect on lifted load, ground conditions, out-of-level, operating speeds or any other condition that could be detrimental to the safe operation of this equipment.

The operator, therefore, has the responsibility to judge the existing conditions and reduce lifted loads and operating speeds accordingly.

- Ratings are for the operation on a firm and level surface, up to 1% gradient.
- At radii and boom lengths where no ratings are shown on chart, operation is not intended nor approved.
- Boom inserts and guy lines must be arranged as shown in the "operator's manual".
- Boom hoist reeving is 10 parts of line.
- Gantry must be in raised position for all conditions.
- Boom backstops are required for all boom lengths.
- The boom should be erected over the front of the crawlers, not laterally.
- When erecting and lowering the boom of 70.1 m and the combination of the boom of 61.0 m and the jib of any length, place blocking steel plates between the ends of the crawlers and the ground.
- Ratings inside of boxes  are based on structural competence.
- The minimum rated load is 1.5 t.
- Crawlers must be fully extended for all crane operations.
- Ratings shown are based on allowable wind speed of 9.8 m/s or less.  
The wind speed mentioned here means the instantaneous wind speed.
- Ratings shown are based on allowable travel speed of 0.1 m/s or less.

## (Crane boom lifting)

- The total load that can be lifted is the value of the weight of main hook block, slings, and all other load handling accessories deducted from crane boom ratings shown.

## (Fixed jib lifting)

- The total load that can be lifted is the value of the weight of jib hook block, slings, and all other load handling accessories deducted from fixed jib ratings shown.
- The availability of fixed jib mounting
  - On crane boom : Range 27.4 m to 61.0 m.

## <Reference Information>

### Main hoist loads

No. of Parts of Line	1	2	3	4	5
Maximum Loads (kN)	108	216	324	431	539
Maximum Loads (t)	11.0	22.0	33.0	44.0	55.0

No. of Parts of Line	6	7	8	9*	10*
Maximum Loads (kN)	647	755	863	971	1,079
Maximum Loads (t)	66.0	77.0	88.0	99.0	110.0

\*Use auxiliary sheave

### Auxiliary hoist loads

No. of Parts of Line	1	2
Maximum Loads (kN)	108	216
Maximum Loads (t)	11.0	22.0

Weight of hook block				
Hook Block	110 t	70 t	35 t	Ball Hook
Weight (t)	1.7	0.9	0.7	0.45

Operation of this equipment in excess of rated loads or disregard of instruction voids the warranty.

# LIFTING CAPACITIES



## Crane Boom Lifting Capacities

Counterweight: 34.6 t  
Carbody Weight: 6.5 t

Unit: metric ton

Working radius (m)	Boom length (m)											Working radius (m)
	15.2	18.3	21.3	24.4	27.4	30.5	33.5	36.6	39.6	42.7		
3.5	3.6m/110.0											3.5
4.0	98.6	4.1m/95.3	4.6m/86.0									4.0
5.0	77.7	77.7	77.7	77.0	5.5m/66.0	5.9m/58.9						5.0
6.0	62.2	62.2	62.2	62.2	60.7	58.2	6.4m/52.4	6.8m/47.1				6.0
7.0	53.3	53.2	53.2	53.1	51.2	49.4	47.6	46.0	7.3m/42.7	7.8m/38.9		7.0
8.0	44.5	44.4	44.4	44.2	44.2	42.7	41.4	40.1	38.9	37.7		8.0
9.0	37.6	37.5	37.4	37.3	37.3	37.2	36.5	35.5	34.5	33.5		9.0
10.0	32.5	32.4	32.3	32.2	32.2	32.1	32.0	31.7	30.9	30.1		10.0
12.0	25.5	25.3	25.2	25.1	25.1	24.9	24.9	24.8	24.7	24.6		12.0
14.0	20.8	20.7	20.6	20.4	20.4	20.3	20.2	20.1	20.0	19.9		14.0
16.0	14.4m/20.1	17.4	17.3	17.1	17.1	16.9	16.9	16.7	16.7	16.6		16.0
18.0		17.1m/16.0	14.8	14.7	14.6	14.5	14.4	14.3	14.2	14.1		18.0
20.0			19.7m/13.2	12.8	12.7	12.6	12.5	12.4	12.3	12.2		20.0
22.0				11.3	11.2	11.1	11.0	10.8	10.8	10.6		22.0
24.0				22.4m/11.1	10.0	9.8	9.8	9.6	9.5	9.4		24.0
26.0					25.0m/9.5	8.8	8.7	8.6	8.5	8.4		26.0
28.0						27.6m/8.1	7.9	7.7	7.6	7.5		28.0
30.0							7.2	7.0	6.9	6.8		30.0
32.0							30.3m/7.1	6.4	6.3	6.1		32.0
34.0								32.9m/6.1	5.7	5.6		34.0
36.0									35.6m/5.3	5.1		36.0
38.0										4.7		38.0
40.0										38.2m/4.6		40.0
Reeves	10	9	8	7	6	6	5	5	4	4		Reeves

Working radius (m)	Boom length (m)										Working radius (m)
	45.7	48.8	51.8	54.9	57.9	61.0	64.0	67.1	70.1		
8.0	8.2m/35.6	8.7m/32.9									8.0
9.0	32.4	31.7	9.1m/30.4	9.6m/28.1							9.0
10.0	29.1	28.5	27.7	27.0	26.1	10.5m/22.0	10.9m/22.0	11.4m/19.1	11.9m/15.0		10.0
12.0	24.0	23.6	23.0	22.4	21.7	21.4	20.8	18.4	14.9		12.0
14.0	19.8	19.7	19.4	18.9	18.4	18.2	17.6	16.5	13.1		14.0
16.0	16.4	16.4	16.3	16.1	15.8	15.6	15.2	14.8	11.7		16.0
18.0	13.9	13.9	13.8	13.6	13.5	13.5	13.2	12.8	10.4		18.0
20.0	12.0	12.0	11.9	11.7	11.6	11.6	11.4	11.3	9.3		20.0
22.0	10.5	10.5	10.3	10.2	10.0	10.1	9.9	9.8	8.3		22.0
24.0	9.2	9.2	9.1	8.9	8.8	8.8	8.6	8.5	7.5		24.0
26.0	8.2	8.2	8.0	7.9	7.7	7.7	7.6	7.5	6.7		26.0
28.0	7.3	7.3	7.2	7.0	6.9	6.9	6.7	6.6	6.0		28.0
30.0	6.6	6.5	6.4	6.3	6.1	6.1	6.0	5.8	5.3		30.0
32.0	5.9	5.9	5.8	5.6	5.5	5.5	5.3	5.2	4.7		32.0
34.0	5.4	5.3	5.2	5.0	4.9	4.9	4.7	4.6	4.2		34.0
36.0	4.9	4.8	4.7	4.6	4.4	4.4	4.2	4.1	3.7		36.0
38.0	4.5	4.4	4.3	4.1	4.0	3.9	3.8	3.6	3.2		38.0
40.0	4.1	4.0	3.9	3.7	3.5	3.5	3.3	3.2	2.7		40.0
42.0	40.8m/4.0	3.7	3.5	3.3	3.2	3.1	2.9	2.8	2.3		42.0
44.0		43.5m/3.5	3.2	3.0	2.8	2.8	2.6	2.4	1.9		44.0
46.0			2.9	2.7	2.5	2.5	2.3	2.1	1.6		46.0
48.0			46.1m/2.9	2.4	2.2	2.2	2.0	1.8			48.0
50.0				48.8m/2.3	2.0	1.9	1.7	1.6			50.0
52.0					51.4m/1.8	1.7	1.5				52.0
54.0						1.5					54.0
Reeves	4	3	3	3	3	2	2	2	2		Reeves

Note:

Ratings according to EN13000.

Ratings shown in   are determined by the strength of the boom or other structural components.

Lifting capacities may vary depending on hook used or with/without auxiliary sheave.

Please refer rated chart in operator's cabin.



# Fixed Jib Lifting Capacities (Without Main Hook Block)

## (Jib Offset Angle : 10°)

Counterweight: 34.6 t  
Carbody Weight: 6.5 t

Unit: metric ton

Boom length (m)		27.4					30.5					33.5					Boom length (m)
Jib length (m)		9.1	12.2	15.2	18.3	21.3	9.1	12.2	15.2	18.3	21.3	9.1	12.2	15.2	18.3	21.3	Jib length (m)
Working radius (m)	10.0	10.9					10.9										10.0
	12.0	10.9	10.9	10.9			10.9	10.9	10.9			10.9	10.9				12.0
	14.0	10.9	10.9	10.9	9.8	7.1	10.9	10.9	10.9	9.9	7.1	10.9	10.9	10.9	9.9		14.0
	16.0	10.9	10.9	10.9	9.6	6.9	10.9	10.9	10.9	9.7	6.9	10.9	10.9	10.9	9.7	7.0	16.0
	18.0	10.9	10.9	10.2	8.9	6.7	10.9	10.9	10.7	9.3	6.8	10.9	10.9	10.9	9.5	6.8	18.0
	20.0	10.9	10.9	9.2	8.0	6.5	10.9	10.9	9.7	8.4	6.6	10.9	10.9	10.2	8.8	6.7	20.0
	22.0	10.9	10.2	8.4	7.3	6.4	10.9	10.9	8.9	7.6	6.5	10.9	10.9	9.3	8.0	6.5	22.0
	24.0	10.1	9.4	7.7	6.7	6.0	10.0	10.0	8.2	7.0	6.3	9.9	10.0	8.6	7.4	6.4	24.0
	26.0	9.1	8.7	7.2	6.2	5.5	8.9	9.1	7.6	6.5	5.8	8.8	9.0	8.0	6.8	6.1	26.0
	28.0	8.2	8.1	6.7	5.7	5.1	8.0	8.2	7.0	6.0	5.4	7.9	8.1	7.4	6.3	5.6	28.0
	30.0	7.4	7.5	6.2	5.4	4.7	7.3	7.4	6.6	5.6	5.0	7.2	7.3	7.0	5.9	5.2	30.0
	32.0	6.8	6.9	5.9	5.0	4.4	6.6	6.7	6.2	5.3	4.7	6.5	6.6	6.5	5.6	4.9	32.0
	34.0		6.3	5.5	4.7	4.2	6.1	6.2	5.9	5.0	4.4	6.0	6.1	6.1	5.3	4.6	34.0
	36.0			5.3	4.5	3.9		5.7	5.6	4.7	4.1	5.5	5.5	5.6	5.0	4.3	36.0
	38.0				4.2	3.7			5.3	4.5	3.9	5.0	5.1	5.2	4.7	4.1	38.0
	40.0				4.0	3.5			4.9	4.3	3.7		4.7	4.8	4.5	3.9	40.0
	42.0					3.3				4.1	3.5			4.4	4.3	3.7	42.0
	44.0					3.2				3.9	3.4			4.1	4.1	3.5	44.0
	46.0										3.2				3.8	3.4	46.0
	48.0															3.3	48.0
50.0															3.1	50.0	
Reeves	1	1	1	1	1	1	1	1	1	1	1	1	1	1	1	Reeves	

Boom length (m)		36.6					39.6					42.7					Boom length (m)
Jib length (m)		9.1	12.2	15.2	18.3	21.3	9.1	12.2	15.2	18.3	21.3	9.1	12.2	15.2	18.3	21.3	Jib length (m)
Working radius (m)	12.0	10.9	10.9				10.9					10.9					12.0
	14.0	10.9	10.9	10.9	10.0		10.9	10.9	10.9			10.9	10.9	10.9			14.0
	16.0	10.9	10.9	10.9	9.8	7.0	10.9	10.9	10.9	9.8	7.1	10.9	10.9	10.9	9.9	7.1	16.0
	18.0	10.9	10.9	10.9	9.6	6.9	10.9	10.9	10.9	9.7	6.9	10.9	10.9	10.9	9.7	6.9	18.0
	20.0	10.9	10.9	10.6	9.1	6.7	10.9	10.9	10.9	9.5	6.8	10.9	10.9	10.9	9.6	6.8	20.0
	22.0	10.9	10.9	9.7	8.3	6.6	10.9	10.9	10.1	8.7	6.6	10.8	10.9	10.5	9.0	6.7	22.0
	24.0	9.7	9.9	9.0	7.7	6.4	9.6	9.8	9.4	8.0	6.5	9.5	9.7	9.8	8.3	6.5	24.0
	26.0	8.7	8.8	8.3	7.1	6.3	8.6	8.7	8.7	7.4	6.4	8.4	8.6	8.7	7.7	6.4	26.0
	28.0	7.8	7.9	7.8	6.6	5.9	7.7	7.8	7.9	6.9	6.1	7.6	7.7	7.8	7.2	6.3	28.0
	30.0	7.0	7.1	7.2	6.2	5.5	6.9	7.0	7.1	6.5	5.7	6.8	6.9	7.0	6.8	5.9	30.0
	32.0	6.4	6.5	6.6	5.8	5.1	6.3	6.4	6.5	6.1	5.4	6.1	6.2	6.3	6.4	5.6	32.0
	34.0	5.8	5.9	6.0	5.5	4.8	5.7	5.8	5.9	5.8	5.0	5.6	5.7	5.8	5.8	5.2	34.0
	36.0	5.3	5.4	5.5	5.2	4.6	5.2	5.3	5.4	5.4	4.8	5.0	5.2	5.2	5.3	5.0	36.0
	38.0	4.9	4.9	5.0	4.9	4.3	4.7	4.8	4.9	5.0	4.5	4.6	4.7	4.8	4.9	4.7	38.0
	40.0	4.5	4.5	4.6	4.7	4.1	4.3	4.4	4.5	4.6	4.3	4.2	4.3	4.4	4.4	4.5	40.0
	42.0		4.2	4.3	4.3	3.9	4.0	4.1	4.1	4.2	4.1	3.8	3.9	4.0	4.1	4.1	42.0
	44.0			3.9	4.0	3.7		3.7	3.8	3.9	3.9	3.5	3.6	3.7	3.7	3.8	44.0
	46.0				3.7	3.6			3.5	3.6	3.6		3.3	3.4	3.4	3.5	46.0
	48.0				3.4	3.4			3.2	3.3	3.3		3.1	3.1	3.2	3.2	48.0
	50.0					3.2				3.0	3.1			2.9	2.9	3.0	50.0
52.0										2.9				2.7	2.7	52.0	
54.0										2.6				2.5	2.5	54.0	
56.0															2.3	56.0	
Reeves	1	1	1	1	1	1	1	1	1	1	1	1	1	1	1	Reeves	

Note:

Ratings according to EN13000.

Ratings shown in   are determined by the strength of the boom or other structural components.

Lifting capacities may vary depending on hook used or with/without auxiliary sheave.

Please refer rated chart in operator's cabin.

# LIFTING CAPACITIES



## Fixed Jib Lifting Capacities (Without Main Hook Block) (Jib Offset Angle : 10°)

Counterweight: 34.6 t  
Carbody Weight: 6.5 t

Unit: metric ton

Boom length (m)		45.7					48.8					51.8					Boom length (m)	
Jib length (m)		9.1	12.2	15.2	18.3	21.3	9.1	12.2	15.2	18.3	21.3	9.1	12.2	15.2	18.3	21.3	Jib length (m)	
Working radius (m)	14.0	10.9	10.9				10.9	10.9				10.9					14.0	
	16.0	10.9	10.9	10.9	9.9		10.9	10.9	10.9	10.0		10.9	10.9	10.9			16.0	
	18.0	10.9	10.9	10.9	9.8	7.0	10.9	10.9	10.9	9.8	7.0	10.9	10.9	10.9	9.8	7.0	18.0	
	20.0	10.9	10.9	10.9	9.6	6.8	10.9	10.9	10.9	9.6	6.9	10.9	10.9	10.9	9.7	6.9	20.0	
	22.0	10.6	10.8	10.9	9.3	6.7	10.5	10.7	10.8	9.5	6.8	10.4	10.6	10.7	9.5	6.8	22.0	
	24.0	9.3	9.5	9.6	8.6	6.6	9.3	9.4	9.5	8.9	6.6	9.1	9.3	9.4	9.2	6.7	24.0	
	26.0	8.3	8.4	8.5	8.0	6.5	8.2	8.4	8.5	8.3	6.5	8.1	8.2	8.3	8.4	6.6	26.0	
	28.0	7.4	7.5	7.6	7.5	6.4	7.3	7.4	7.6	7.6	6.4	7.2	7.3	7.4	7.5	6.5	28.0	
	30.0	6.6	6.8	6.9	6.9	6.2	6.5	6.7	6.8	6.9	6.3	6.4	6.5	6.7	6.7	6.4	30.0	
	32.0	6.0	6.1	6.2	6.3	5.8	5.9	6.0	6.1	6.2	6.0	5.7	5.9	6.0	6.1	6.1	32.0	
	34.0	5.4	5.5	5.6	5.7	5.5	5.3	5.4	5.5	5.6	5.6	5.2	5.3	5.4	5.5	5.5	34.0	
	36.0	4.9	5.0	5.1	5.2	5.2	4.8	4.9	5.0	5.1	5.1	4.7	4.8	4.9	4.9	5.0	36.0	
	38.0	4.4	4.5	4.6	4.7	4.7	4.3	4.4	4.5	4.6	4.7	4.2	4.3	4.4	4.5	4.5	38.0	
	40.0	4.0	4.1	4.2	4.3	4.3	3.9	4.0	4.1	4.2	4.2	3.8	3.9	4.0	4.1	4.1	40.0	
	42.0	3.7	3.8	3.8	3.9	4.0	3.6	3.7	3.8	3.8	3.9	3.4	3.5	3.6	3.7	3.7	42.0	
	44.0	3.3	3.4	3.5	3.6	3.6	3.2	3.3	3.4	3.5	3.5	3.1	3.2	3.3	3.4	3.4	44.0	
	46.0	3.1	3.1	3.2	3.3	3.3	3.0	3.0	3.1	3.2	3.2	2.8	2.9	3.0	3.1	3.1	46.0	
	48.0	2.8	2.9	2.9	3.0	3.1	2.7	2.8	2.8	2.9	3.0	2.5	2.6	2.7	2.8	2.8	48.0	
	50.0		2.6	2.7	2.8	2.8	2.4	2.5	2.6	2.7	2.7	2.2	2.3	2.4	2.5	2.5	50.0	
	52.0			2.4	2.5	2.6		2.2	2.3	2.4	2.4	1.9	2.0	2.1	2.2	2.2	52.0	
54.0				2.3	2.3			2.0	2.1	2.2		1.8	1.9	1.9	2.0	54.0		
56.0				2.0	2.1			1.8	1.9	1.9		1.5	1.6	1.7	1.8	56.0		
58.0					1.9				1.7	1.7						58.0		
60.0										1.5						60.0		
Reeves	1	1	1	1	1	1	1	1	1	1	1	1	1	1	1	Reeves		

Boom length (m)		54.9					57.9					61.0					Boom length (m)	
Jib length (m)		9.1	12.2	15.2	18.3	21.3	9.1	12.2	15.2	18.3	21.3	9.1	12.2	15.2	18.3	21.3	Jib length (m)	
Working radius (m)	14.0	10.9															14.0	
	16.0	10.9	10.9	10.9			10.9	10.9				10.9	10.9				16.0	
	18.0	10.9	10.9	10.9	9.9	7.1	10.9	10.9	10.9	9.9		10.9	10.9	10.9	9.9		18.0	
	20.0	10.9	10.9	10.9	9.7	6.9	10.9	10.9	10.9	9.8	7.0	10.9	10.8	10.8	9.8	7.0	20.0	
	22.0	10.3	10.5	10.6	9.6	6.8	10.1	10.3	10.5	9.6	6.8	10.1	10.3	10.4	9.7	6.9	22.0	
	24.0	9.0	9.2	9.3	9.4	6.7	8.9	9.0	9.2	9.3	6.7	8.8	9.0	9.1	9.2	6.8	24.0	
	26.0	7.9	8.1	8.2	8.3	6.6	7.8	8.0	8.1	8.2	6.6	7.7	7.9	8.0	8.1	6.7	26.0	
	28.0	7.0	7.2	7.3	7.4	6.5	6.9	7.0	7.2	7.3	6.5	6.8	7.0	7.1	7.2	6.6	28.0	
	30.0	6.3	6.4	6.5	6.6	6.4	6.1	6.3	6.4	6.5	6.4	6.1	6.2	6.3	6.4	6.5	30.0	
	32.0	5.6	5.7	5.8	5.9	6.0	5.4	5.6	5.7	5.8	5.8	5.4	5.5	5.6	5.7	5.8	32.0	
	34.0	5.0	5.1	5.2	5.3	5.4	4.9	5.0	5.1	5.2	5.2	4.8	4.9	5.0	5.1	5.2	34.0	
	36.0	4.5	4.6	4.7	4.8	4.9	4.4	4.5	4.6	4.7	4.7	4.3	4.4	4.5	4.6	4.6	36.0	
	38.0	4.1	4.2	4.3	4.3	4.4	3.9	4.0	4.1	4.2	4.3	3.8	3.9	4.0	4.1	4.2	38.0	
	40.0	3.6	3.8	3.9	3.9	4.0	3.5	3.6	3.7	3.8	3.8	3.4	3.5	3.6	3.7	3.8	40.0	
	42.0	3.3	3.4	3.5	3.6	3.6	3.1	3.2	3.3	3.4	3.5	3.0	3.1	3.3	3.3	3.4	42.0	
	44.0	2.9	3.1	3.1	3.2	3.3	2.7	2.9	3.0	3.1	3.1	2.6	2.7	2.9	3.0	3.0	44.0	
	46.0	2.6	2.7	2.8	2.9	3.0	2.4	2.5	2.6	2.7	2.8	2.2	2.4	2.5	2.6	2.7	46.0	
	48.0	2.2	2.4	2.5	2.6	2.6	2.0	2.2	2.3	2.4	2.4	1.9	2.1	2.2	2.3	2.3	48.0	
	50.0	2.0	2.1	2.2	2.3	2.3	1.7	1.9	2.0	2.1	2.1	1.6	1.8	1.9	2.0	2.0	50.0	
	52.0	1.7	1.8	1.9	2.0	2.1		1.6	1.7	1.8	1.8			1.6	1.7	1.7	52.0	
54.0		1.6	1.7	1.7	1.8				1.5	1.6						54.0		
56.0				1.5	1.6											56.0		
Reeves	1	1	1	1	1	1	1	1	1	1	1	1	1	1	1	Reeves		

Note:

Ratings according to EN13000.

Ratings shown in   are determined by the strength of the boom or other structural components.

Lifting capacities may vary depending on hook used or with/without auxiliary sheave.

Please refer rated chart in operator's cabin.



# Fixed Jib Lifting Capacities (Without Main Hook Block)

## (Jib Offset Angle : 30°)

Counterweight: 34.6 t  
Carbody Weight: 6.5 t

Unit: metric ton

Boom length (m)		27.4					30.5					33.5					Boom length (m)	
Jib length (m)		9.1	12.2	15.2	18.3	21.3	9.1	12.2	15.2	18.3	21.3	9.1	12.2	15.2	18.3	21.3	Jib length (m)	
Working radius (m)	12.0	9.5																12.0
	14.0	9.5	7.0				9.5					9.5						14.0
	16.0	9.5	7.0	5.2			9.5	7.0				9.5	7.0					16.0
	18.0	9.5	7.0	5.2	4.2		9.5	7.0	5.2			9.5	7.0	5.2				18.0
	20.0	9.5	7.0	5.2	4.2	4.2	9.5	7.0	5.2	4.2		9.5	7.0	5.2	4.2			20.0
	22.0	9.1	6.7	5.2	4.2	4.0	9.4	6.9	5.2	4.2	4.1	9.5	7.0	5.2	4.2	4.1		22.0
	24.0	8.6	6.4	5.1	4.2	3.7	8.9	6.5	5.2	4.2	3.8	9.2	6.7	5.2	4.2	3.9		24.0
	26.0	8.1	6.1	4.9	4.1	3.5	8.6	6.3	5.0	4.2	3.6	8.8	6.4	5.1	4.2	3.7		26.0
	28.0	7.6	5.8	4.6	3.9	3.3	8.2	6.0	4.8	4.0	3.4	8.1	6.2	4.9	4.1	3.5		28.0
	30.0	7.1	5.5	4.5	3.7	3.2	7.7	5.8	4.6	3.8	3.3	7.3	6.0	4.7	3.9	3.3		30.0
	32.0	6.6	5.2	4.3	3.6	3.0	6.9	5.6	4.4	3.7	3.1	6.5	5.8	4.5	3.8	3.2		32.0
	34.0	6.1	4.9	4.1	3.4	2.9	6.3	5.4	4.2	3.5	3.0	5.9	5.6	4.4	3.6	3.1		34.0
	36.0		4.6	3.9	3.2	2.8	5.8	5.2	4.0	3.4	2.9	5.3	5.4	4.3	3.5	3.0		36.0
	38.0			3.7	3.0	2.7		5.0	3.8	3.3	2.8	4.8	5.2	4.2	3.4	2.9		38.0
	40.0			3.5	2.8	2.6			3.6	3.2	2.7		4.7	4.1	3.3	2.8		40.0
	42.0				2.6	2.5			3.4	3.1	2.6		4.4	4.0	3.2	2.7		42.0
	44.0					2.4				3.0	2.5			3.9	3.1	2.6		44.0
	46.0					2.3				2.9	2.4				3.0	2.5		46.0
	48.0										2.3				2.9	2.4		48.0
	50.0															2.3		50.0
Reeves	1	1	1	1	1	1	1	1	1	1	1	1	1	1	1	1	Reeves	

Boom length (m)		36.6					39.6					42.7					Boom length (m)	
Jib length (m)		9.1	12.2	15.2	18.3	21.3	9.1	12.2	15.2	18.3	21.3	9.1	12.2	15.2	18.3	21.3	Jib length (m)	
Working radius (m)	14.0	9.5					9.5											14.0
	16.0	9.5	7.0				9.5	7.0				9.5						16.0
	18.0	9.5	7.0	5.2			9.5	7.0	5.2			9.5	7.0					18.0
	20.0	9.5	7.0	5.2	4.2		9.5	7.0	5.2	4.2		9.5	7.0	5.2				20.0
	22.0	9.5	7.0	5.2	4.2	4.2	9.5	7.0	5.2	4.2	4.2	9.5	7.0	5.2	4.2			22.0
	24.0	9.5	6.9	5.2	4.2	4.0	9.5	7.0	5.2	4.2	4.0	9.5	7.0	5.2	4.2	4.1		24.0
	26.0	8.9	6.6	5.2	4.2	3.8	8.8	6.7	5.2	4.2	3.8	8.7	6.9	5.2	4.2	3.9		26.0
	28.0	8.0	6.3	5.0	4.2	3.6	7.9	6.5	5.1	4.2	3.6	7.8	6.6	5.2	4.2	3.7		28.0
	30.0	7.2	6.1	4.8	4.0	3.4	7.1	6.3	4.9	4.1	3.5	7.0	6.4	5.0	4.2	3.6		30.0
	32.0	6.5	5.9	4.7	3.8	3.3	6.4	6.1	4.8	3.9	3.3	6.3	6.2	4.9	4.0	3.4		32.0
	34.0	5.8	5.7	4.5	3.7	3.1	5.7	5.9	4.6	3.8	3.2	5.7	5.9	4.7	3.9	3.3		34.0
	36.0	5.3	5.5	4.4	3.6	3.0	5.2	5.4	4.5	3.7	3.1	5.2	5.3	4.6	3.7	3.2		36.0
	38.0	4.8	5.1	4.2	3.5	2.9	4.7	4.8	4.3	3.5	3.0	4.5	4.9	4.4	3.6	3.1		38.0
	40.0	4.4	4.6	4.0	3.4	2.8	4.2	4.4	4.1	3.4	2.9	4.0	4.2	4.3	3.5	3.0		40.0
	42.0	4.0	4.2	3.8	3.3	2.7	3.9	4.0	3.9	3.4	2.8	3.6	3.8	4.0	3.4	2.9		42.0
	44.0		3.9	3.6	3.2	2.7	3.5	3.6	3.7	3.3	2.7	3.3	3.4	3.6	3.3	2.8		44.0
	46.0			3.4	3.1	2.6		3.3	3.5	3.2	2.6	3.0	3.1	3.3	3.2	2.7		46.0
	48.0			3.2	3.0	2.5			3.2	3.1	2.5		2.8	3.0	3.1	2.6		48.0
	50.0				2.9	2.4			2.9	3.0	2.4		2.6	2.7	2.8	2.5		50.0
	52.0					2.3				2.7	2.3			2.5	2.5	2.4		52.0
54.0					2.2				2.5	2.2				2.3	2.3		54.0	
56.0										2.1				2.1	2.2		56.0	
58.0										2.0					2.0		58.0	
60.0															1.8		60.0	
Reeves	1	1	1	1	1	1	1	1	1	1	1	1	1	1	1	1	Reeves	

Note:

Ratings according to EN13000.

Ratings shown in   are determined by the strength of the boom or other structural components.

Lifting capacities may vary depending on hook used or with/without auxiliary sheave.

Please refer rated chart in operator's cabin.

# LIFTING CAPACITIES

## Fixed Jib Lifting Capacities (Without Main Hook Block) (Jib Offset Angle : 30°)

Counterweight: 34.6 t  
Carbody Weight: 6.5 t

Unit: metric ton

Boom length (m)		45.7					48.8					51.8					Boom length (m)	
Jib length (m)		9.1	12.2	15.2	18.3	21.3	9.1	12.2	15.2	18.3	21.3	9.1	12.2	15.2	18.3	21.3	Jib length (m)	
Working radius (m)	16.0	9.5					9.5					9.5					16.0	
	18.0	9.5	7.0				9.5	7.0				9.5	7.0				18.0	
	20.0	9.5	7.0	5.2			9.5	7.0	5.2			9.5	7.0	5.2			20.0	
	22.0	9.5	7.0	5.2	4.2		9.5	7.0	5.2	4.2		9.5	7.0	5.2	4.2		22.0	
	24.0	9.5	7.0	5.2	4.2	4.1	9.5	7.0	5.2	4.2	4.2	9.5	7.0	5.2	4.2	4.2	24.0	
	26.0	8.6	7.0	5.2	4.2	3.9	8.5	7.0	5.2	4.2	4.0	8.4	7.0	5.2	4.2	4.0	26.0	
	28.0	7.6	6.8	5.2	4.2	3.8	7.6	6.9	5.2	4.2	3.8	7.4	7.0	5.2	4.2	3.9	28.0	
	30.0	6.8	6.5	5.1	4.2	3.6	6.8	6.7	5.2	4.2	3.7	6.7	6.8	5.2	4.2	3.7	30.0	
	32.0	6.1	6.3	5.0	4.1	3.5	6.1	6.3	5.0	4.1	3.5	6.0	6.2	5.1	4.2	3.6	32.0	
	34.0	5.5	5.7	4.8	3.9	3.3	5.5	5.7	4.9	4.0	3.4	5.4	5.6	5.0	4.1	3.4	34.0	
	36.0	5.0	5.2	4.7	3.8	3.2	4.9	5.1	4.7	3.9	3.3	4.8	5.0	4.8	3.9	3.3	36.0	
	38.0	4.6	4.7	4.5	3.7	3.1	4.5	4.6	4.6	3.8	3.2	4.4	4.5	4.7	3.8	3.2	38.0	
	40.0	3.8	4.0	4.4	3.6	3.0	3.6	4.2	4.4	3.7	3.1	3.9	4.1	4.2	3.7	3.1	40.0	
	42.0	3.4	3.6	4.0	3.5	2.9	3.2	3.8	4.0	3.6	3.0	3.0	3.7	3.9	3.6	3.0	42.0	
	44.0	3.1	3.2	3.4	3.4	2.8	2.9	3.1	3.6	3.5	2.9	2.7	3.4	3.5	3.5	2.9	44.0	
	46.0	2.7	2.9	3.0	3.2	2.8	2.6	2.7	2.9	3.4	2.8	2.3	2.5	3.2	3.3	2.9	46.0	
	48.0	2.5	2.6	2.7	2.9	2.7	2.3	2.4	2.6	3.1	2.7	2.1	2.2	2.4	3.0	2.8	48.0	
	50.0	2.2	2.3	2.5	2.6	2.6	2.1	2.2	2.3	2.4	2.7	1.8	1.9	2.1	2.7	2.7	50.0	
	52.0		2.1	2.2	2.3	2.4	1.9	1.9	2.1	2.2	2.3	1.6	1.7	1.8	2.0	2.5	52.0	
	54.0			2.0	2.1	2.2		1.7	1.8	1.9	2.0		1.5	1.6	1.7	1.8	54.0	
56.0			1.8	1.9	1.9			1.6	1.7	1.8				1.5	1.6	56.0		
58.0				1.7	1.7			1.5	1.5	1.6						58.0		
60.0					1.6											60.0		
Reeves	1	1	1	1	1	1	1	1	1	1	1	1	1	1	1	Reeves		

Boom length (m)		54.9					57.9					61.0					Boom length (m)	
Jib length (m)		9.1	12.2	15.2	18.3	21.3	9.1	12.2	15.2	18.3	21.3	9.1	12.2	15.2	18.3	21.3	Jib length (m)	
Working radius (m)	18.0	9.5					9.5					9.5					18.0	
	20.0	9.5	7.0				9.5	7.0				9.5	7.0				20.0	
	22.0	9.5	7.0	5.2			9.5	7.0	5.2			9.5	7.0	5.2			22.0	
	24.0	9.4	7.0	5.2	4.2		9.3	7.0	5.2	4.2		9.2	7.0	5.2	4.2		24.0	
	26.0	8.3	7.0	5.2	4.2	4.1	8.1	7.0	5.2	4.2	4.1	8.1	7.0	5.2	4.2	4.1	26.0	
	28.0	7.3	7.0	5.2	4.2	3.9	7.2	7.0	5.2	4.2	4.0	7.1	7.0	5.2	4.2	4.0	28.0	
	30.0	6.5	6.8	5.2	4.2	3.8	6.4	6.6	5.2	4.2	3.8	6.3	6.6	5.2	4.2	3.8	30.0	
	32.0	5.8	6.0	5.2	4.2	3.6	5.7	5.9	5.2	4.2	3.7	5.6	5.9	5.2	4.2	3.7	32.0	
	34.0	5.2	5.4	5.0	4.1	3.5	5.1	5.3	5.1	4.2	3.5	5.0	5.3	5.2	4.2	3.6	34.0	
	36.0	4.7	4.9	4.9	4.0	3.4	4.6	4.8	4.9	4.1	3.4	4.5	4.7	4.9	4.1	3.5	36.0	
	38.0	4.2	4.4	4.6	3.9	3.3	4.1	4.3	4.4	3.9	3.3	4.0	4.2	4.4	4.0	3.4	38.0	
	40.0	3.8	4.0	4.1	3.8	3.2	3.7	3.8	4.0	3.8	3.2	3.6	3.8	3.9	3.9	3.3	40.0	
	42.0	3.4	3.6	3.7	3.7	3.1	3.3	3.4	3.6	3.7	3.1	3.2	3.4	3.5	3.7	3.2	42.0	
	44.0	3.1	3.2	3.4	3.5	3.0	2.9	3.1	3.2	3.4	3.0	2.8	3.0	3.2	3.3	3.1	44.0	
	46.0	2.1	2.3	3.0	3.2	2.9	1.9	2.7	2.9	3.0	3.0	2.4	2.6	2.8	3.0	3.0	46.0	
	48.0	1.8	2.0	2.7	2.9	2.8	1.6	1.8	2.6	2.7	2.9		2.3	2.5	2.6	2.8	48.0	
	50.0	1.6	1.7	1.9	2.6	2.7		1.5	2.2	2.4	2.5		2.0	2.1	2.3	2.4	50.0	
	52.0		1.5	1.6	1.8	2.4				2.1	2.2			1.8	2.0	2.1	52.0	
	54.0				1.5	2.1					1.9				1.7	1.8	54.0	
	56.0										1.7					1.6	56.0	
Reeves	1	1	1	1	1	1	1	1	1	1	1	1	1	1	1	Reeves		

Note:

Ratings according to EN13000.

Ratings shown in   are determined by the strength of the boom or other structural components.

Lifting capacities may vary depending on hook used or with/without auxiliary sheave.

Please refer rated chart in operator's cabin.



# SUPPLEMENTAL DATA FOR CLAMSHELL RATING CHART

- Operating radius is the horizontal distance from centerline of rotation to a vertical line through the center of gravity of the load.
- The weight of bucket, slings and all other load handling accessories shall be considered part of the lifted load.
- Ratings shown are based on freely suspended loads and make no allowance for such factors as wind effect on lifted load, ground conditions, out-of-level, operating speeds or any other condition that could be detrimental to the safe operation of this equipment. The operator, therefore, has the responsibility to judge the existing conditions and reduce lifted loads and operating speeds accordingly.
- Rated loads do not exceed 66% of minimum tipping loads.
- Ratings are for the operation on a firm and level surface, up to 1% gradient.
- At radii and boom lengths where no ratings are shown on chart, operation is not intended nor approved.
- Boom inserts and guy lines must be arranged as shown in the "operator's manual".
- Boom hoist reeving is 10 parts of line.
- Gantry must be in raised position for all conditions.
- Boom backstops are required for all boom lengths.
- The boom should be erected over the front of the crawlers, not laterally.
- Crawlers must be fully extended for all crane operations.

## (Clamshell bucket lifting)

- The total load that can be lifted is the value of the weight of bucket, slings, and all other load handling accessories deducted from main boom ratings shown.
- The weight of bucket and materials must not exceed rated load.
- Optimum bucket should be required according to material.
- Bucket capacity (m<sup>3</sup>) x specified gravity of material (ton/m<sup>3</sup>) + bucket weight (ton) = rated load.
- Bucket weight must also be decreased according to operating cycle and bucket lowering height.
- Rated loads are determined by stability and boom strength. During simultaneous operations of boom and swing, rapid acceleration or deceleration must be avoided.
- Do not attempt to cast the bucket while swinging or diagonal draw-cutting.

## <Reference Information>

### Main hoist loads

No. of Parts of Line	1
Maximum Loads (kN)	98
Maximum Loads (t)	10.0

### Assembling the counterweight

23.1 ton counterweight  
without carbody weight

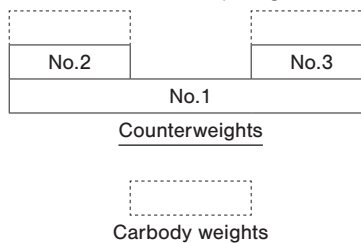

Operation of this equipment in excess of rated loads  
or disregard of instruction voids the warranty.

# LIFTING CAPACITIES



## Clamshell Rating Charts Crane Boom Capacities

Counterweight: 23.1 t  
Without Carbody Weight  
Crawler Fully Extended

Unit: metric ton

Load radius (m) \ Boom length (m)	15.2	18.3	21.3	24.4					Boom length (m) \ Load radius (m)
7.0	10.0								7.0
8.0	10.0	10.0							8.0
9.0	10.0	10.0	10.0						9.0
10.0	10.0	10.0	10.0	9.4					10.0
11.0	10.0	10.0	10.0	9.3					11.0
12.0	10.0	10.0	10.0	9.3					12.0
13.0	10.0	10.0	10.0	9.3					13.0
14.0	10.0	10.0	10.0	9.3					14.0
15.0		10.0	10.0	9.3					15.0
16.0		9.8	9.9	9.0					16.0
17.0			9.3	8.8					17.0
18.0			8.6	8.6					18.0
19.0			7.9	8.2					19.0
20.0				7.6					20.0
21.0				7.1					21.0
22.0									22.0
23.0									23.0
24.0									24.0
25.0									25.0
26.0									26.0
27.0									27.0
28.0									28.0
29.0									29.0
30.0									30.0
31.0									31.0
32.0									32.0
33.0									33.0
<b>Reeves</b>	1	1	1	1					<b>Reeves</b>

Note:  
Please refer rated chart in operator's cabin.

# SUPPLEMENTAL DATA FOR REDUCED WEIGHTS RATING CHART

- Ratings are calculated to comply with EN13000, ISO 4305 and include factors based on a 4 degree tipping angle.
- Operating radius is the horizontal distance from centerline of rotation to a vertical line through the center of gravity of the load.
- The weight of hook block, slings, and all other load handling accessories shall be considered part of the lifted load.
- Ratings shown are based on freely suspended loads and make no allowance for such factors as wind effect on lifted load, ground conditions, out-of-level, operating speeds or any other condition that could be detrimental to the safe operation of this equipment. The operator, therefore, has the responsibility to judge the existing conditions and reduce lifted loads and operating speeds accordingly.
- Ratings are for the operation on a firm and level surface, up to 1% gradient.
- At radii and boom lengths where no ratings are shown on chart, operation is not intended nor approved.
- Boom inserts and guy lines must be arranged as shown in the "operator's manual".
- Boom hoist reeving is 10 parts of line.
- Gantry must be in raised position for all conditions.
- Boom backstops are required for all boom lengths.
- The boom should be erected over the front of the crawlers, not laterally.
- Ratings inside of boxes  are based on structural competence.
- The minimum rated load is 1.5 t.
- Crawlers must be fully extended for all crane operations.
- Ratings shown are based on allowable wind speed of 9.8 m/s or less.  
The wind speed mentioned here means the instantaneous wind speed.
- Ratings shown are based on allowable travel speed of 0.1 m/s or less.

## (Crane boom lifting)

- The total load that can be lifted is the value of the weight of hook block, slings, and all other load handling accessories deducted from main boom ratings shown.

Counterweight	Carbody weight	Boom length	
		Without aux.	With aux.
23.1 ton	Without	15.2 m to 57.9 m	15.2 m to 54.9 m

## Assembling the counterweight

23.1 ton counterweight  
without carbody weight



Counterweights

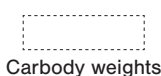

Carbody weights

## <Reference Information>

### Main hoist loads

No. of Parts of Line	1	2	3	4	5
Maximum Loads (kN)	108	216	324	431	539
Maximum Loads (t)	11.0	22.0	33.0	44.0	55.0

No. of Parts of Line	6	7	8	9*	10*
Maximum Loads (kN)	647	755	863	971	1,079
Maximum Loads (t)	66.0	77.0	88.0	99.0	110.0

\*Use auxiliary sheave

### Auxiliary hoist loads

No. of Parts of Line	1	2
Maximum Loads (kN)	108	216
Maximum Loads (t)	11.0	22.0

Weight of hook block				
Hook Block	110 t	70 t	35 t	Ball Hook
Weight (t)	1.7	0.9	0.7	0.45

Operation of this equipment in excess of rated loads or disregard of instruction voids the warranty.

# LIFTING CAPACITIES



## Reduced Weights Rating Charts Crane Boom Lifting Capacities

Counterweight: 23.1 t  
Without Carbody Weight  
Crawler Fully Extended

Unit: metric ton

Working radius (m)	Boom length (m)	15.2	18.3	21.3	24.4	27.4	30.5	33.5	36.6	39.6	42.7	Boom length (m)	Working radius (m)													
	3.5													4.0	4.5	5.0	5.5	6.0	7.0	8.0	9.0	10.0	12.0	14.0	16.0	18.0
3.5	3.6m/94.2												3.5													
4.0	85.3	4.1m/83.3											4.0													
4.5	76.2	75.7	4.6m/69.2										4.5													
5.0	68.9	66.0	62.3	59.1									5.0													
5.5	58.9	58.4	55.5	52.8	5.5m/50.4	5.9m/44.6							5.5													
6.0	50.8	50.4	49.9	47.8	45.7	43.8	6.4m/39.2	6.8m/35.4					6.0													
7.0	39.6	39.3	39.0	38.7	38.4	37.0	35.6	34.4	7.3m/31.7	7.8m/28.6			7.0													
8.0	32.3	32.3	32.2	32.1	32.0	31.9	30.8	29.9	28.8	27.9			8.0													
9.0	27.2	27.2	27.2	27.2	27.2	27.1	27.0	26.3	25.4	24.7			9.0													
10.0	23.5	23.5	23.5	23.5	23.4	23.3	23.2	23.2	22.7	22.0			10.0													
12.0	18.2	18.2	18.2	18.2	18.1	18.0	18.0	17.9	17.9	17.7			12.0													
14.0	14.8	14.8	14.8	14.8	14.7	14.6	14.5	14.4	14.4	14.2			14.0													
16.0	14.4m/14.3	12.5	12.4	12.3	12.2	12.1	12.0	12.0	11.9	11.8			16.0													
18.0		17.1m/11.5	10.6	10.5	10.4	10.3	10.2	10.2	10.1	10.0	9.9		18.0													
20.0			19.7m/9.4	9.1	9.0	8.9	8.7	8.7	8.6	8.5			20.0													
22.0				8.0	7.9	7.7	7.6	7.6	7.5	7.4			22.0													
24.0				22.4m/7.8	7.0	6.8	6.7	6.7	6.6	6.4			24.0													
26.0					25.0m/6.5	6.1	5.9	5.9	5.8	5.7			26.0													
28.0						27.6m/5.6	5.3	5.3	5.1	5.0			28.0													
30.0							4.8	4.7	4.6	4.5			30.0													
32.0								30.3m/4.6	4.3	4.1	4.0		32.0													
34.0									32.9m/4.1	3.7	3.5		34.0													
36.0										35.6m/3.3	3.1		36.0													
38.0											2.8		38.0													
40.0											38.2m/2.6		40.0													
42.0													42.0													
44.0													44.0													
Reeves		10	8	7	6	5	5	4	4	3	3		Reeves													

Working radius (m)	Boom length (m)	45.7	48.8	51.8	54.9	57.9							Boom length (m)	Working radius (m)												
	8.0														9.0	10.0	12.0	14.0	16.0	18.0	20.0	22.0	24.0	26.0	28.0	30.0
8.0	8.2m/26.3	8.7m/24.0												8.0												
9.0	23.9	23.2	9.1m/22.2	9.6m/20.3										9.0												
10.0	21.3	20.8	20.1	19.5	18.9									10.0												
12.0	17.4	17.0	16.5	16.0	15.5									12.0												
14.0	14.1	14.0	13.8	13.4	13.0									14.0												
16.0	11.6	11.6	11.4	11.4	11.0									16.0												
18.0	9.8	9.7	9.6	9.6	9.4									18.0												
20.0	8.3	8.3	8.1	8.1	8.0									20.0												
22.0	7.2	7.1	7.0	7.0	6.8									22.0												
24.0	6.3	6.2	6.1	6.0	5.9									24.0												
26.0	5.5	5.4	5.3	5.3	5.1									26.0												
28.0	4.9	4.8	4.6	4.6	4.5									28.0												
30.0	4.3	4.2	4.1	4.0	3.8									30.0												
32.0	3.8	3.7	3.5	3.5	3.3									32.0												
34.0	3.3	3.3	3.1	3.0	2.8									34.0												
36.0	2.9	2.9	2.7	2.6	2.4									36.0												
38.0	2.6	2.5	2.3	2.2	2.1									38.0												
40.0	2.2	2.2	2.0	1.9	1.7									40.0												
42.0	40.8m/2.1	1.9	1.7	1.6										42.0												
44.0		43.5m/1.6												44.0												
46.0														46.0												
48.0														48.0												
50.0														50.0												
52.0														52.0												
54.0														54.0												
56.0														56.0												
58.0														58.0												
Reeves		3	3	3	2	2								Reeves												

Note:

Ratings according to EN13000.

Ratings shown in   are determined by the strength of the boom or other structural components.

Lifting capacities may vary depending on hook used or with/without auxiliary sheave.

Please refer rated chart in operator's cabin.

# TRANSPORTATION PLAN

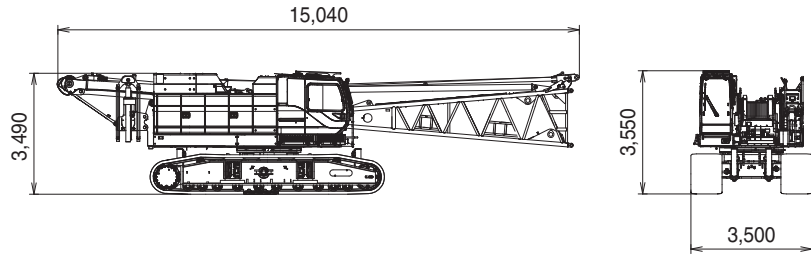
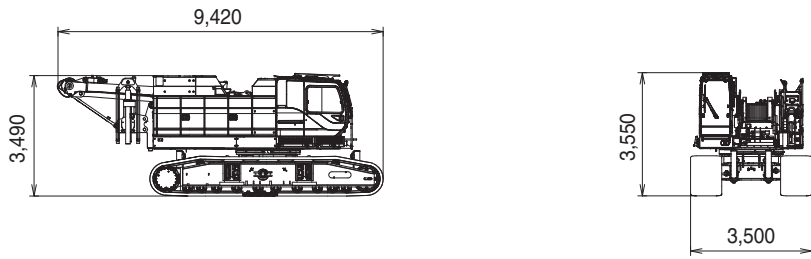
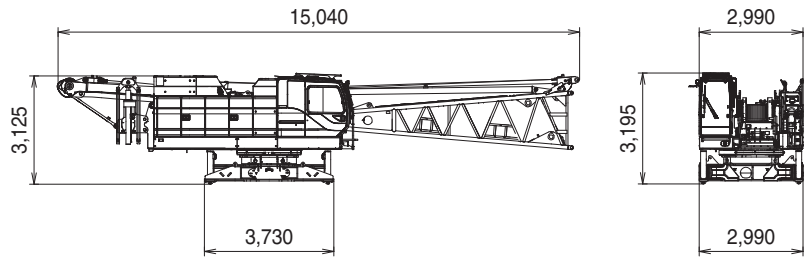
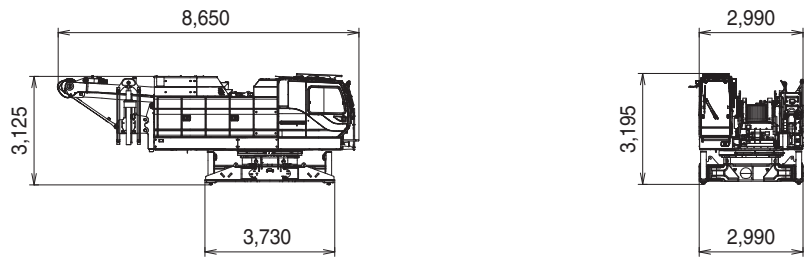
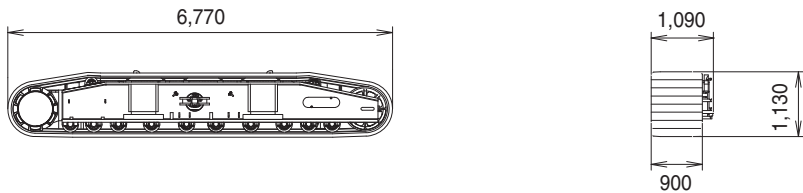
Name	Dimension	Weight (kg)
<p><b>Base Machine</b></p> <ul style="list-style-type: none"> <li>• Gantry</li> <li>• Boom base</li> <li>• Boom drum</li> <li>• Wire rope (Front, rear, boom drum)</li> <li>• Self removal device</li> <li>• Side catwalk</li> <li>• Crawler</li> <li>• Translifter</li> </ul>		59,305
<p><b>Base Machine</b></p> <ul style="list-style-type: none"> <li>• Gantry</li> <li>• Without boom base</li> <li>• Boom drum</li> <li>• Wire rope (Front, rear, boom drum)</li> <li>• Self removal device</li> <li>• Side catwalk</li> <li>• Crawler</li> <li>• Translifter</li> </ul>		56,700
<p><b>Base Machine</b></p> <ul style="list-style-type: none"> <li>• Gantry</li> <li>• Boom base</li> <li>• Boom drum</li> <li>• Wire rope (Front, rear, boom drum)</li> <li>• Self removal device</li> <li>• Without side catwalk</li> <li>• Without crawler</li> <li>• Translifter</li> </ul>		35,240
<p><b>Base Machine</b></p> <ul style="list-style-type: none"> <li>• Gantry</li> <li>• Without boom base</li> <li>• Boom drum</li> <li>• Wire rope (Front, rear, boom drum)</li> <li>• Self removal device</li> <li>• Without side catwalk</li> <li>• Without crawler</li> <li>• Translifter</li> </ul>		32,635
<p><b>Crawler</b></p>		12,035

# PARTS AND ATTACHMENTS

## Base Machine

Boom base, Gantry, Crawler, Wire rope (Front/rear/boom drum)  
Weight: 59,305 kg Width: 3,500 mm

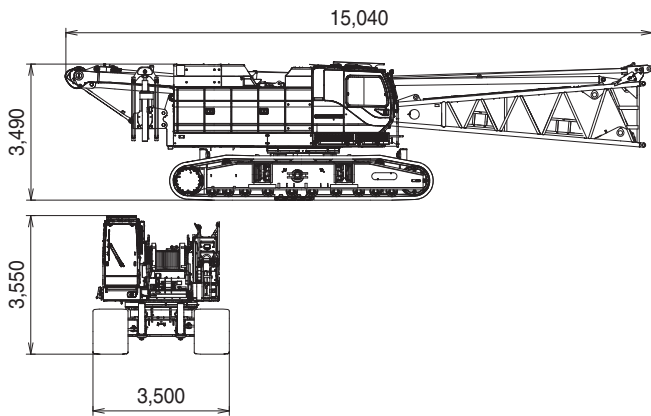

## Crawler

Weight: 12,035 kg

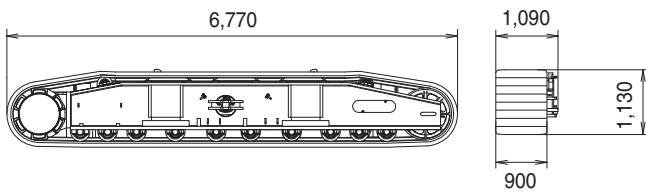

## Translifter

Weight: 370 kg / 1 piece

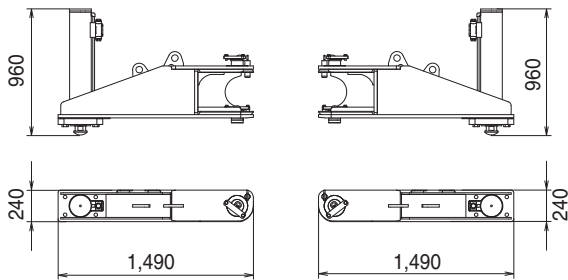

## Backstop

Weight: 440 kg

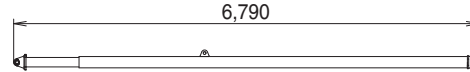

## Jib Tip

Weight: 280 kg

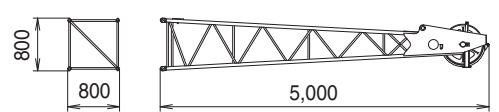

## Jib Base

Weight: 200 kg

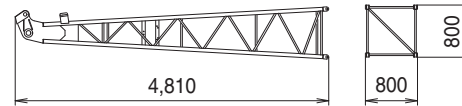

## 3.0 m Jib Insert

Weight: 100 kg

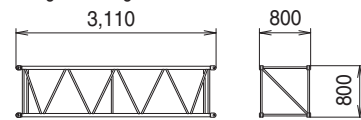

## 6.0 m Jib Insert

Weight: 180 kg

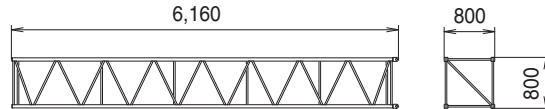

## Strut

Weight: 250 kg

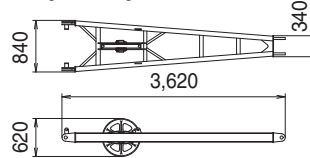

## Auxiliary Sheave

Weight: 330 kg

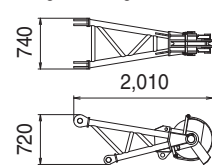

## Counterweight No.1

Weight: 11,600 kg

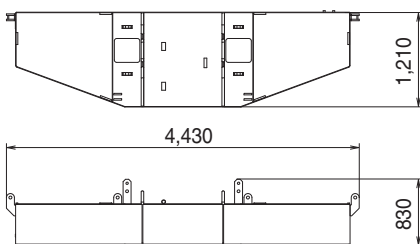

## Counterweight No.3, No.5 (R)

Weight: 5,750 kg

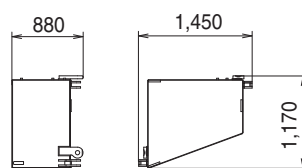

## Counterweight No.2, No.4 (L)

Weight: 5,750 kg

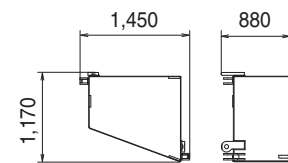

## Carbody Weight (with Float)

Weight: 3,320 kg / 1 piece

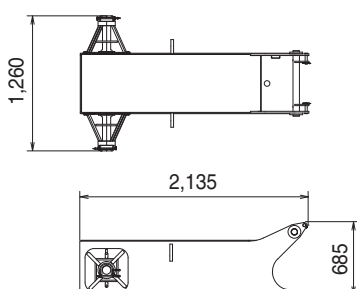

## Carbody Weight (without Float)

Weight: 3,250 kg / 1 piece

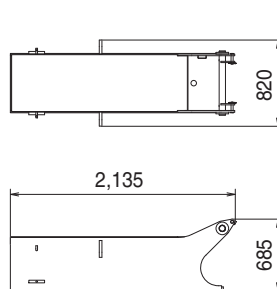

## Self Removal Unit

Weight: 870 kg

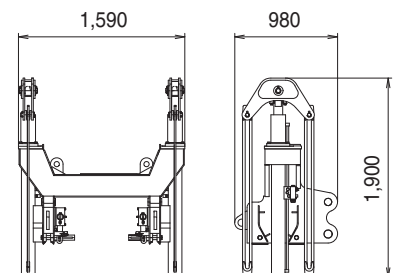

**Boom Tip**  
Weight: 1,535 kg

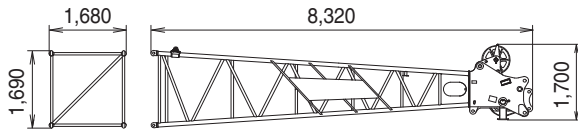

**Boom Base**  
Weight: 2,235 kg

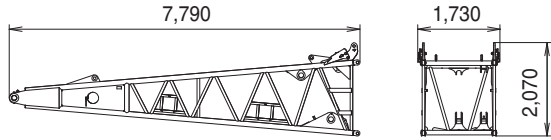

**3.0 m Boom Insert**  
Weight: 385 kg

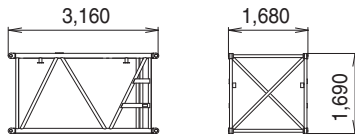

**6.1 m Boom Insert**  
Weight: 655 kg

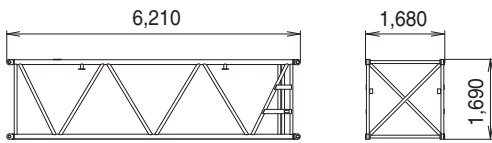

**12.2 m Boom Insert**  
Weight: 1,195 kg

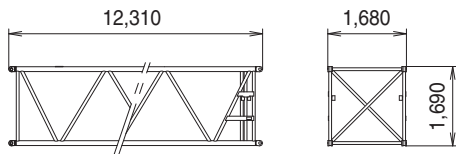

**12.2 m Boom Insert (with Lug)**  
Weight: 1,220 kg

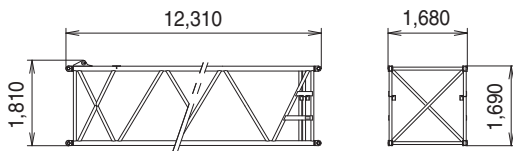

**Gantry**  
Weight: 1,320 kg

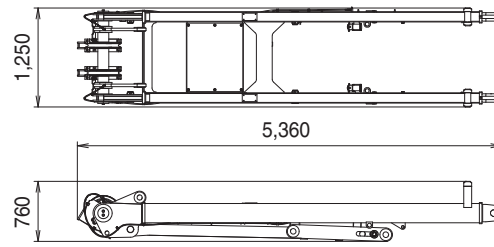

**Upper Spreader**  
Weight: 300 kg

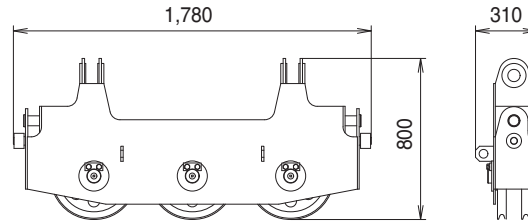

**Lower Spreader**  
Weight: 200 kg

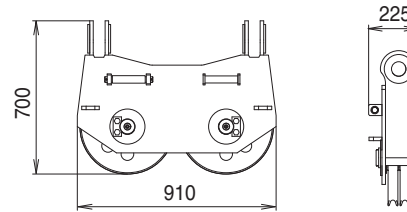

**Ball Hook**  
Weight: 455 kg

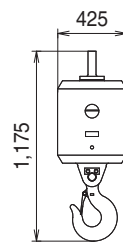

**35 t Hook**  
Weight: 700 kg

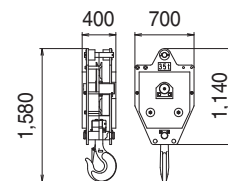

**70 t Hook**  
Weight: 900 kg

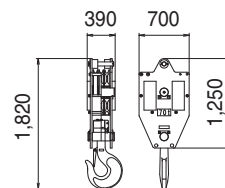

**110 t Hook**  
Weight: 1,700 kg

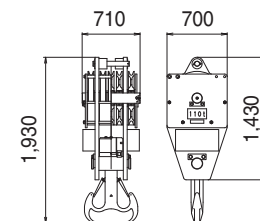

Note: This catalog may contain photographs of machines with specifications, attachments and optional equipment not certified for operation in your country. Please consult KOBELCO for those items you may require. Due to our policy of continual product improvements all designs and specifications are subject to change without advance notice.

Copyright by KOBELCO CONSTRUCTION MACHINERY CO., LTD. No part of this catalog may be reproduced in any manner without notice.



## **KOBELCO CONSTRUCTION MACHINERY CO., LTD.**

Inquiries To:

5-15, Kitashinagawa 5-chome, Shinagawa-ku, Tokyo 141-8626 JAPAN

Tel: +81-3-5789-2121 Fax: +81-3-5789-3372

URL: <https://www.kobelcocm-global.com>