

Hydraulic Crawler Crane

CKS

1350

Model : CKS1350

- Max. Lifting Capacity: **135 t x 4.5 m**
- Max. Lifting Capacity With Luffing Jib: **36.0 t x 12.0 m**
- Max. Crane Boom Length: **76.2 m**
- Max. Luffing Boom Length: **47.9 m**
- Max. Long Boom Length: **82.3 m**
- Max. Fixed Jib Combination: **61.0 m + 30.5 m**
- Max. Luffing Jib Combination: **47.9 m + 32.0 m**
44.8 m + 53.3 m

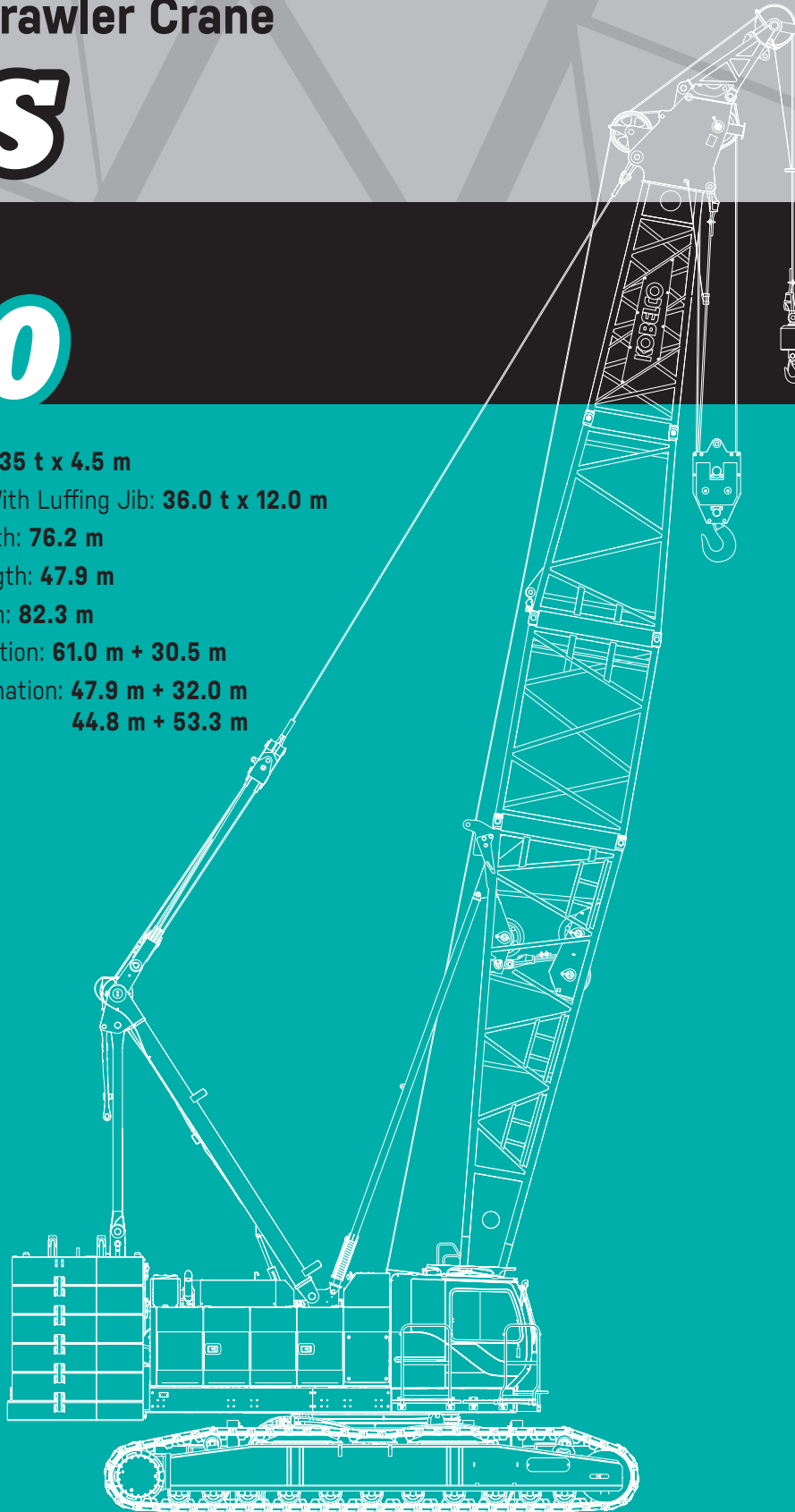

KOBELCO



CKS1350 CONTENTS

3	SPECIFICATIONS
5	GENERAL DIMENSIONS
7	BOOM AND JIB ARRANGEMENTS
11	WORKING RANGES
17	SUPPLEMENTAL DATA
18	LIFTING CAPACITIES
27	SUPPLEMENTAL DATA
28	LIFTING CAPACITIES
36	SUPPLEMENTAL DATA FOR CLAMSHELL
37	LIFTING CAPACITIES
38	SUPPLEMENTAL DATA FOR REDUCED WEIGHTS
39	LIFTING CAPACITIES
40	SUPPLEMENTAL DATA FOR BARGE
42	LIFTING CAPACITIES
43	TRANSPORTATION PLAN
45	PARTS AND ATTACHMENTS

SPECIFICATIONS



Power Plant

Model: HINO P11C-VH

Type: 4 cycle, water-cooled, vertical in-line 6, direct injection, turbo-charger, intercooler

Displacement: 10.52 L

Rated power: 271 kW/1,850 min⁻¹

Max. Torque: 1,470 N·m/1,400 min⁻¹

Cooling System: Water-cooled

Starter: 24V-6kW

Radiator: Corrugated type core, thermostatically controlled

Air cleaner: Dry type with replaceable paper element

Throttle: Twist grip type hand throttle, electrically actuated

Fuel filter: Replaceable paper element

Batteries: Two 12 V x 136 Ah/5HR capacity batteries, series connected

Fuel tank capacity: 400 L



Hydraulic System

Main pumps: 4 variable displacement piston pumps

Control: Full-flow hydraulic control system for infinitely variable pressure to all winches, propel and swing. Controls respond instantly to the touch, delivering smooth function operation.

Cooling: Oil-to-air heat exchanger (plate-fin type)

Filtration: Full-flow and bypass type with replaceable element

Max. relief valve pressure:

Load hoist, boom hoist and propel system: 31.9 MPa

Swing system: 27.5 MPa

Control system: 5.4 MPa

Oil Quantity (at the reference level): 455 L



Boom Hoisting System

Powered by a hydraulic motor through a planetary reducer.

Brake: A spring-set, hydraulically released multiple-disc brake is mounted on the boom hoist motor and operated through a counter-balance valve.

Drum Lock: External ratchet for locking drum

Drum: Single drum, grooved for 20 mm dia. wire rope

Line Speed: Single line on first drum layer

Hoisting/Lowering: 48 to 2 m/min

Boom hoisting/lowering: 20 mm x 190 m

Boom guy line: 30 mm

Boom backstops: Required for all boom length



Load Hoisting System

Front and rear drums for load hoist powered by a hydraulic variable plunger motors, driven through planetary reducers.

Negative Brake: A spring-set, hydraulically released multiple-disc brake is mounted on the hoist motor and operated through a counter-balance valve. (Positive free fall brake is optional)

Drum Lock: External ratchet for locking drum

Drums:

Front Drums:

666 mm P.C.D x 672 mm wide drum, grooved for 26 mm wire rope. Rope capacity is 275 m working length and 350 m storage length.

Rear Drum: 666 mm P.C.D x 672 mm, grooved for 26 mm wire rope. Rope capacity is 255 m working length and 350 m storage length.

Diameter of wire rope

Main winch: 26 mm x 275 m

Aux. winch: 26 mm x 255 m

Third winch: 26 mm x 240 m

Line Speed*:

Hoisting/lowering: 120 to 3 m/min

Line Pull:

Max. Line Pull*: 234 kN {23.8 tf}
(Referential performance)

Rated Line Pull: 132 kN {13.5 tf}

*Single line on first drum layer



Swing System

Swing unit is powered by hydraulic motor driving spur gears through planetary reducer, the swing system provides 360° rotation.

Swing parking brakes: A spring-set, hydraulically released multiple-disc brake is mounted on swing motor.

Swing circle: Single-row ball bearing with an integral internally cut swing gear.

Swing lock: Manually, four position lock for transportation

Swing Speed: 2.1 min⁻¹



Upper Structure

Torsion-free precision machined upper frame. All components are located clearly and service friendly. Engine will with low noise level.

Counterweight: 55.0 ton



Cab & Control

Totally enclosed, full vision cab with safety glass, fully adjustable, high backed seat with a headrest and armrests, and intermittent wiper and window washer (skylight and front window).

Cab fittings:

Air conditioner, convenient compartment (for tool), cup holder, cigarette lighter, sun visor, roof blind, tinted glass, floor mat, footrest, and shoe tray



Lower Structure

Steel-welded carbody with axles. Crawler assemblies are designed with quick disconnect feature for individual removal as a unit from axles. Crawler belt tension is maintained by hydraulic jack force on the track adjusting bearing block.

Carbody weight: 10.8 ton

Crawler drive: Independent hydraulic propel drive is built into each crawler side frame. Each drive consists of a hydraulic motor propelling a driving tumbler through a planetary gear box. Hydraulic motor and gear box are built into the crawler side frame within the shoe width.

Crawler brakes: Spring-set, hydraulically released parking brakes are built into each propel drive.

Steering mechanism: A hydraulic propel system provides both skid steering (driving one track only) and counter-rotating steering (driving each track in opposite directions).

Track rollers: Sealed track rollers for maintenance-free operation.

Shoe (flat): 910 mm wide each crawler

Max. gradeability: 30%



Weight

Including upper and lower machine, 55.0 ton counterweight and 10.8 ton carbody weight, basic boom (or basic boom + basic jib), hook, and other accessories.

Weight: 136 ton

Ground pressure: 106 kPa



Attachment

Boom & Jib:

Welded lattice construction using tubular, high-tensile steel chords with pin connection between sections.

Boom and Jib length

	Min. Length (Min. combination)	Max. Length (Max. combination)
Crane Boom	15.2 m	76.2 m
Fixed Jib	24.4 m + 12.2 m	61.0 m + 30.5 m

Main Specifications (Model: CKS1350)

Crane Boom	
Max. Lifting Capacity	135 t x 4.5 m
Max. Length	76.2 m
Fixed Jib	
Max. Lifting Capacity	26.8 t x 16.0 m
Max. Combination	61.0 m + 30.5 m
Long Boom	
Max. Lifting Capacity	44.3 t/10.6 m
Max. Length	82.3 m
Luffing Boom	
Max. Lifting Capacity	80 t/ 8.0 m
Max. Length	47.9 m
Luffing Jib	
Max. Jib Length	53.3 m
Max. Combination	44.8 m + 53.3 m, 47.9 m + 32.0 m
Main & Aux. Winch	
Max. Line Speed (1st layer)	120 m/min
Rated Line Pull (Single line)	132 kN {13.5 tf}
Wire Rope Diameter	26 mm
Wire Rope Length	275m (Main), 255 m (Aux.)
Brake Type (free fall)	Wet-type multiple disc brake (Optional)
Working Speed	
Swing Speed	2.1 min ⁻¹ {rpm}
Travel Speed	1.3/0.9 km/h

Power Plant	
Model	HINO P11C-VH
Engine Output	271 kW/1850 min ⁻¹
Fuel Tank	400 L
Hydraulic System	
Main Pumps	4 variable displacement
Max. Pressure	31.9 MPa {325 kgf/cm ² }
Oil Quantity (at the reference level)	455 L
Self-Removal Device	
	counterweight/crawler self-removal device
Weight	
Operating Weight	136 t * ¹
Ground Pressure	106 kPa
Counterweight	55,000 kg
Transport Weight	32,430 kg * ²

Units are SI units. { } indicates conventional units.

Line speeds in table are for light loads. Line speed varies with load.

*¹ Including upper and lower machine, 55.0 ton counterweight, 10.8 ton carbody weight, basic boom, hook, and other accessories.

*² Base Machine with gantry, wire ropes (front/rear/boom hoist)

GENERAL DIMENSIONS

(Unit: mm)

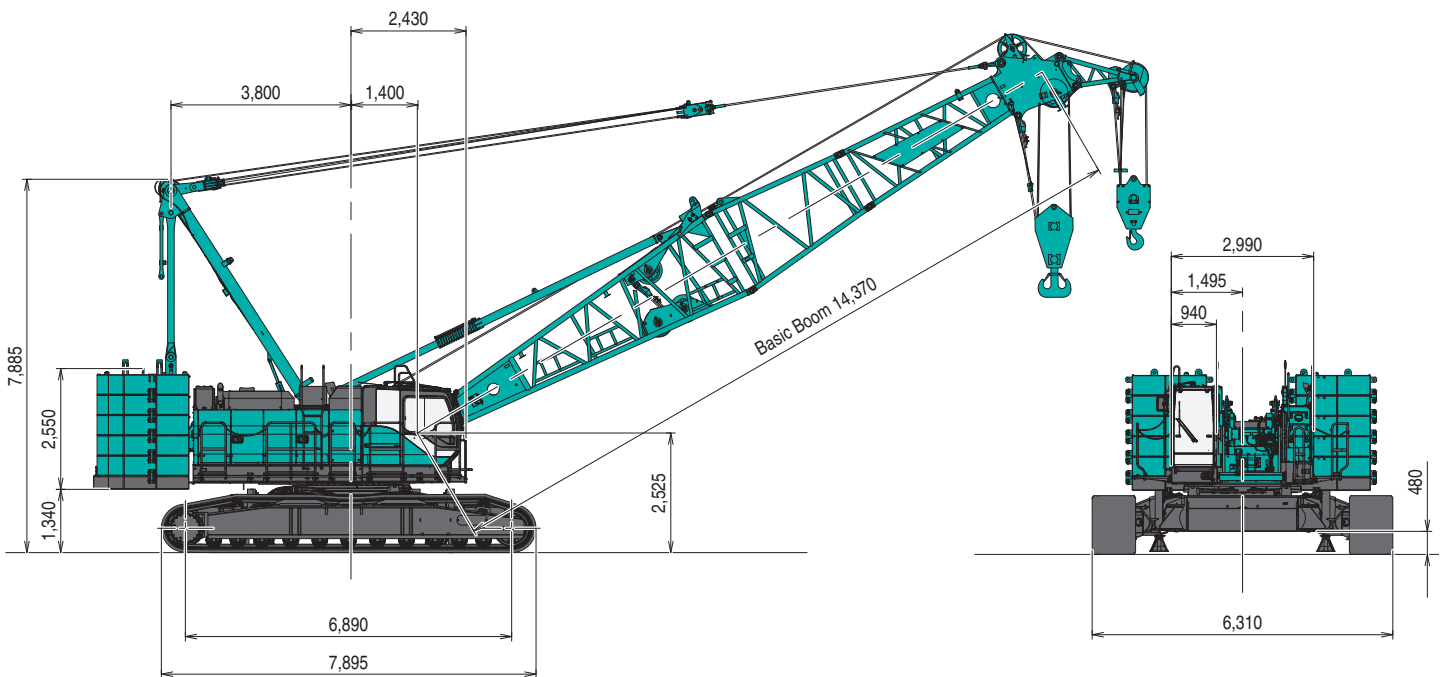
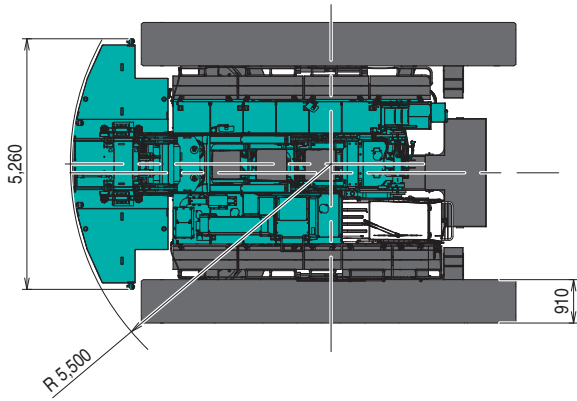

This catalog may contain photographs of machines with specifications, attachments and optional equipment.

Limit of Hook Lifting

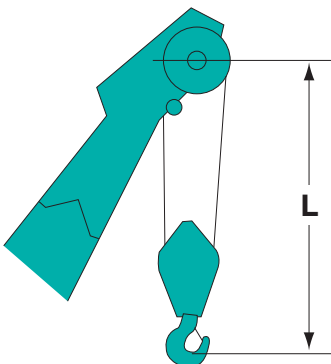

Hook	L
135 t hook	4.7 m
70 t hook	4.5 m
35 t hook	4.3 m

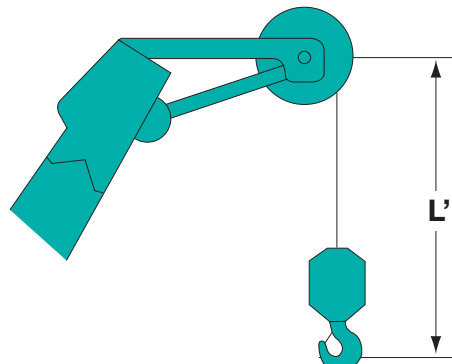

Hook	L'
35 t hook	3.7 m
Ball hook	3.4 m

Luffing Jib

(Unit: mm)

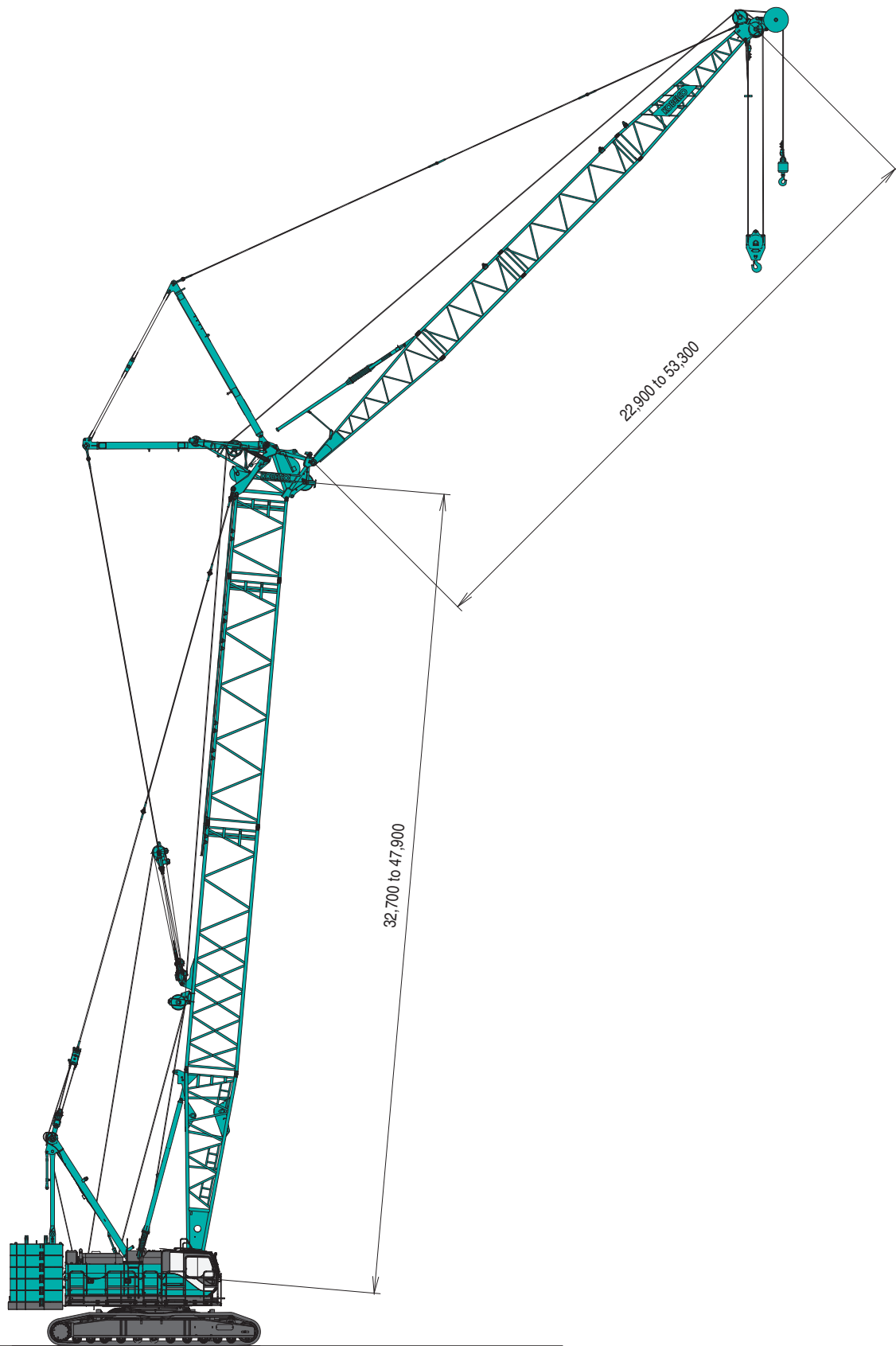

This catalog may contain photographs of machines with specifications, attachments and optional equipment.

BOOM AND JIB ARRANGEMENTS

Crane Boom Arrangements

Boom length m (ft)	Boom arrangement
15.2 (50)	
18.3 (60)	※
21.3 (70)	※
	※
24.4 (80)	※
	※
	※
27.4 (90)	※
	※
	※
	※
30.5 (100)	※
	※
	※
	※
	※
33.5 (110)	※
	※
	※
	※
36.6 (120)	※
	※
	※
	※
	※
	※
39.6 (130)	※
	※
	※
	※
	※
	※
	※
42.7 (140)	※
	※
	※
	※
45.7 (150)	※
	※
	※
	※
	※
	※
48.8 (160)	※
	※
	※
	※
	※
	※

Boom length m (ft)	Boom arrangement
51.8 (170)	※
	※
	※
	※
54.9 (180)	※
	※
	※
	※
	※
	※
57.9 (190)	※
	※
	※
	※
	※
	※
61.0 (200)	※
	※
	※
	※
64.0 (210)	※
	※
	※
67.1 (220)	※
	※
	※
70.1 (230)	※
73.2 (240)	※
	※
76.2 (250)	※

Symbol	Boom Length	Remarks
	7.6 m	Boom Base
	4.6 m	Boom Tip
	3.0 m	Tapered Boom
	3.0 m	Insert Boom
	6.1 m	Insert Boom
	9.1 m	Insert Boom

↗ mark shows the guy line installing position when the fixed jib is used.

※ Indicates the most flexible combination of insert booms, which can be modified to form all shorter boom arrangements.

Long Boom Arrangements

Boom length m (ft)	Boom arrangement
51.8 (170)	
54.9 (180)	
57.9 (190)	
61.0 (200)	
64.0 (210)	
67.1 (220)	
70.1 (230)	
73.2 (240)	
76.2 (250)	
79.2 (260)	
82.3 (270)	

Symbol	Long Boom Length	Remarks
	7.6 m	Boom Base
	6.4 m	Luffing Jib Tip
	3.0 m	Tapered Boom
	3.0 m	Insert Boom
	6.1 m	Insert Boom
	9.1 m	Insert Boom
	9.1 m	Special Insert Boom for Luffing
	4.3 m	Relay Jib
	3.0 m	Luffing Insert Jib
	6.1 m	Luffing Insert Jib
	9.1 m	Luffing Insert Jib

Fixed Jib Arrangements

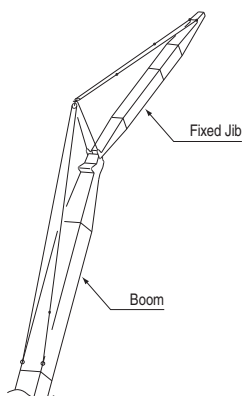

Crane boom length	Jib length m (ft)	Jib arrangement
24.4 m to 61.0 m	12.2 (40)	
	18.3 (60)	
	24.4 (80)	
	30.5 (100)	

Symbol	Jib Length	Remarks
	4.6 m	Jib Base
	4.6 m	Jib Tip
	3.0 m	Insert Jib
	6.1 m	Insert Jib

BOOM AND JIB ARRANGEMENTS

Luffing Boom Arrangements for Luffing

Boom length m (ft)	Boom arrangement
32.7 (107)	
35.7 (117)	
38.8 (127)	※
41.8 (137)	※
44.8 (147)	※

Boom length m (ft)	Boom arrangement
47.9 (157)	※

Symbol	Luffing Boom Length	Remarks
	7.6 m	Boom Base
	0.7 m	Luffing Boom Tip
	3.0 m	Insert Boom
	6.1 m	Insert Boom
	9.1 m	Insert Boom
	9.1 m	Special Insert Boom for Luffing

※Indicates the most flexible combination of insert luffing booms, which can be modified to form all shorter luffing boom arrangements.

Luffing Boom Arrangements for Crane

Boom length m (ft)	Boom arrangement
14.4 (47)	
17.4 (57)	※
20.5 (67)	※
23.5 (77)	※
	※
26.6 (87)	※
	※
29.6 (97)	※
	※
32.7 (107)	※
	※
35.7 (117)	※
	※

Boom length m (ft)	Boom arrangement
38.8 (127)	※
	※
41.8 (137)	※
	※
44.8 (147)	※
	※
47.9 (157)	※
	※

Symbol	Boom Length	Remarks
	7.6 m	Boom Base
	0.7 m	Luffing Boom Tip
	3.0 m	Insert Boom
	6.1 m	Insert Boom
	9.1 m	Insert Boom
	9.1 m	Special Insert Boom for Luffing

※Indicates the most flexible combination of insert luffing booms, which can be modified to form all shorter luffing boom arrangements.

Luffing Jib Arrangements

Jib length m (ft)	Jib arrangement
22.9 (75)	
25.9 (85)	※
29.0 (95)	※
32.0 (105)	※
35.1 (115)	※
38.1 (125)	※
41.1 (135)	※

Jib length m (ft)	Jib arrangement
44.2 (145)	※
47.2 (155)	※
50.3 (165)	※
53.3 (175)	※

Symbol	Boom Length	Remarks
	6.1 m	Luffing Jib Base
	6.4 m	Luffing Jib Tip
	4.3 m	Relay Jib
	3.0 m	Luffing Insert Jib
	6.1 m	Luffing Insert Jib
	9.1 m	Luffing Insert Jib

※ Indicates the most flexible combination of insert luffing jibs, which can be modified to form all shorter luffing jib arrangements.

WORKING RANGES

Crane Boom

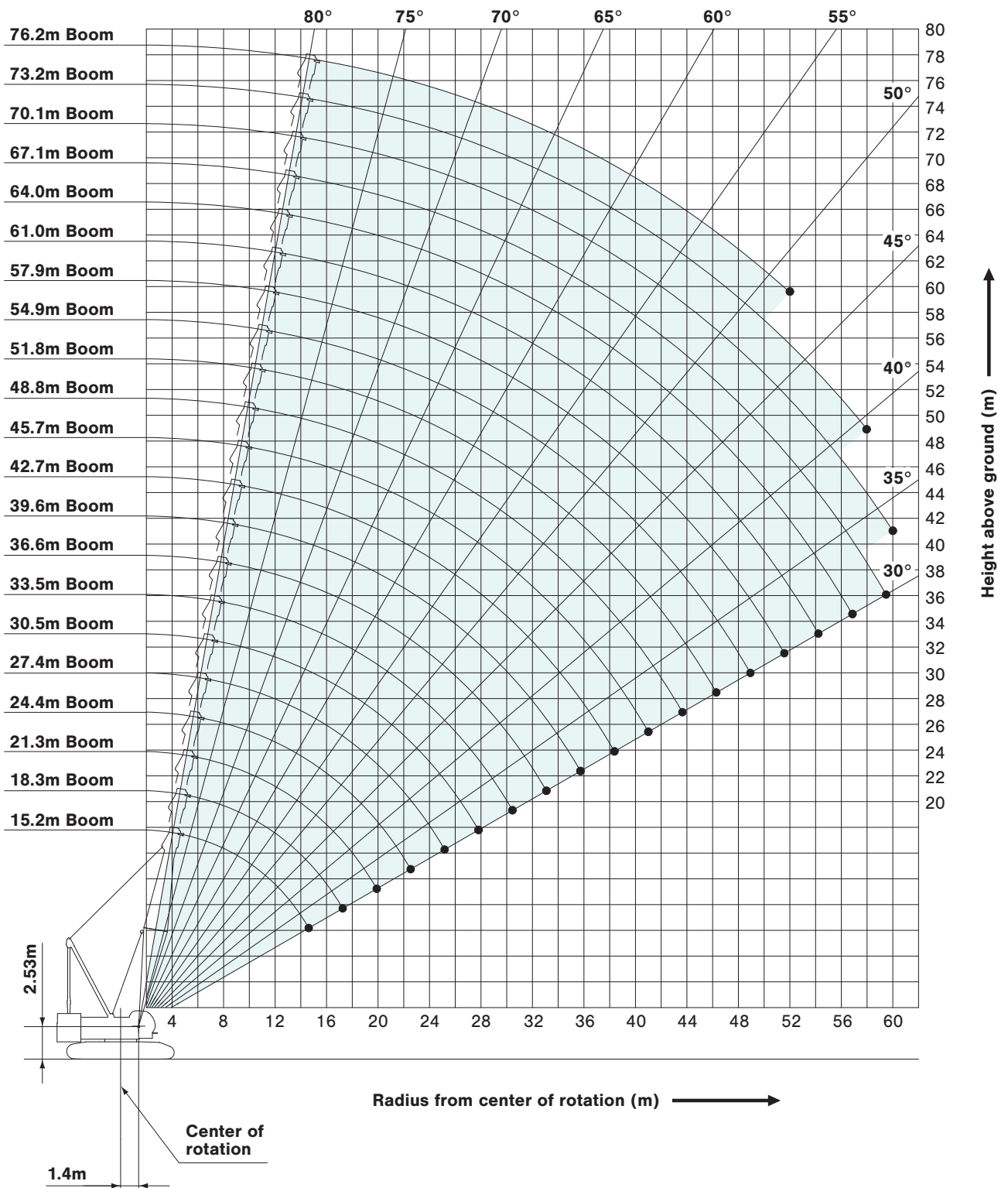

Fixed Jib 10°

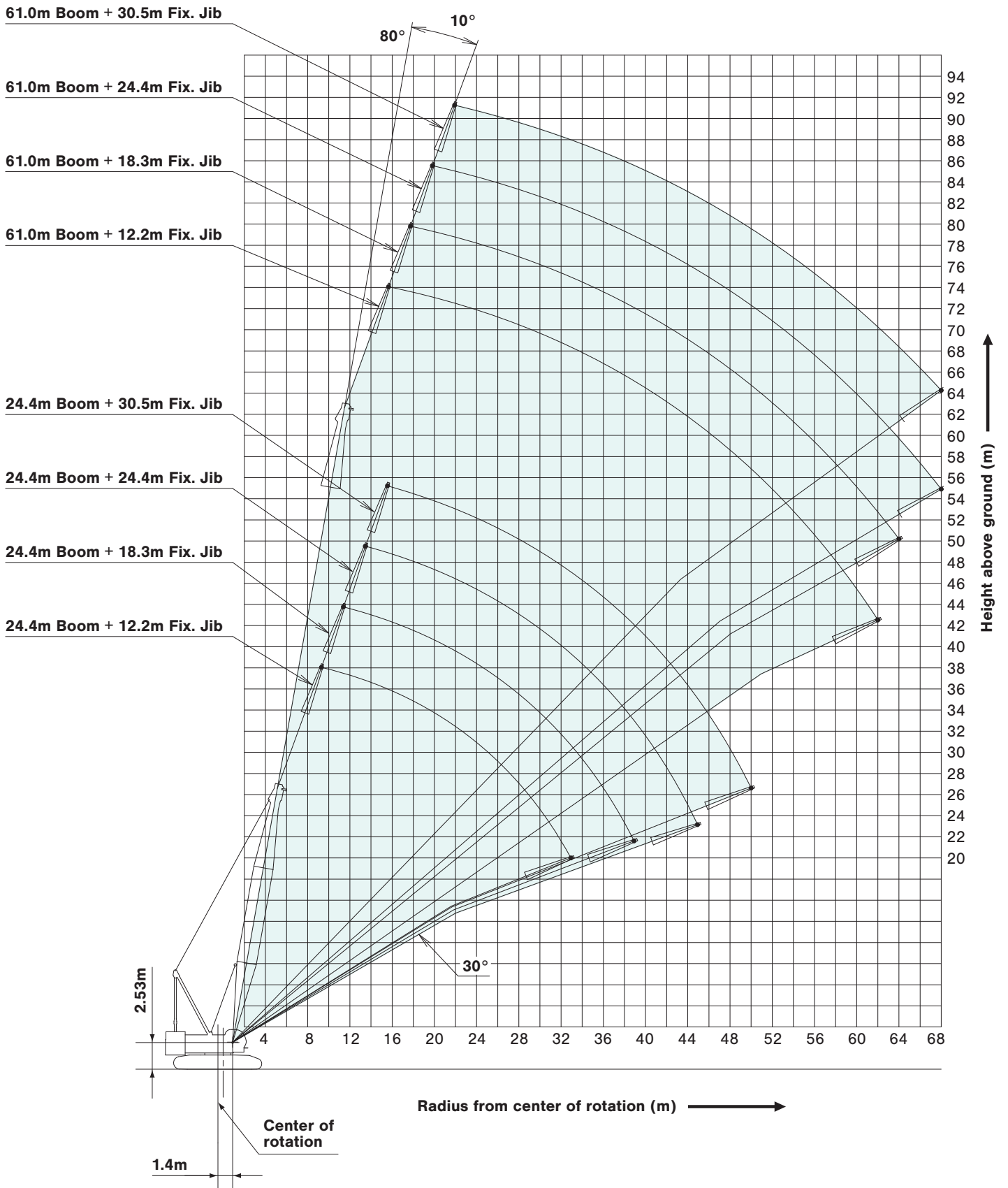

WORKING RANGES

Fixed Jib 30°

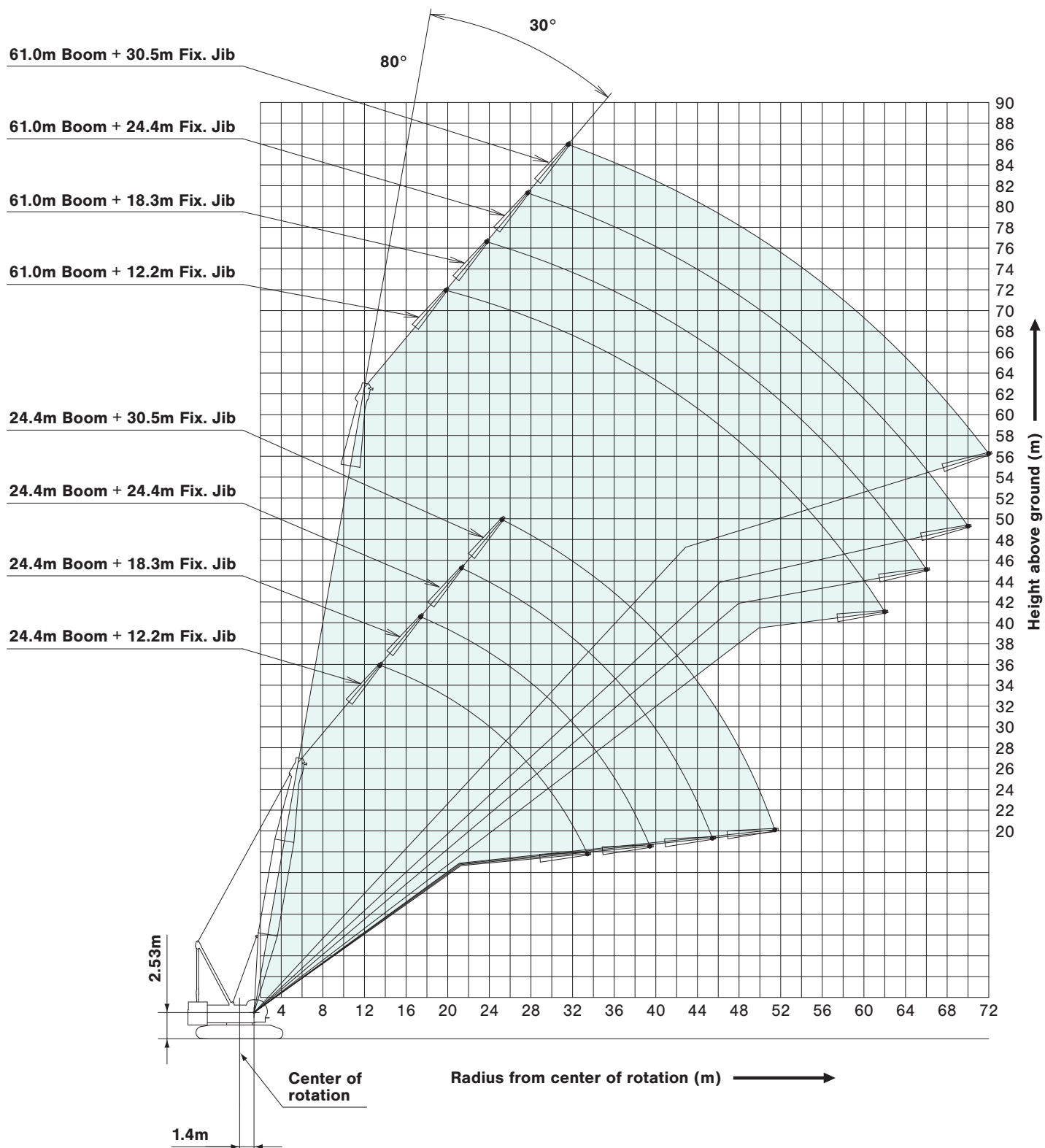

Luffing Jib

Boom Angle: 88°

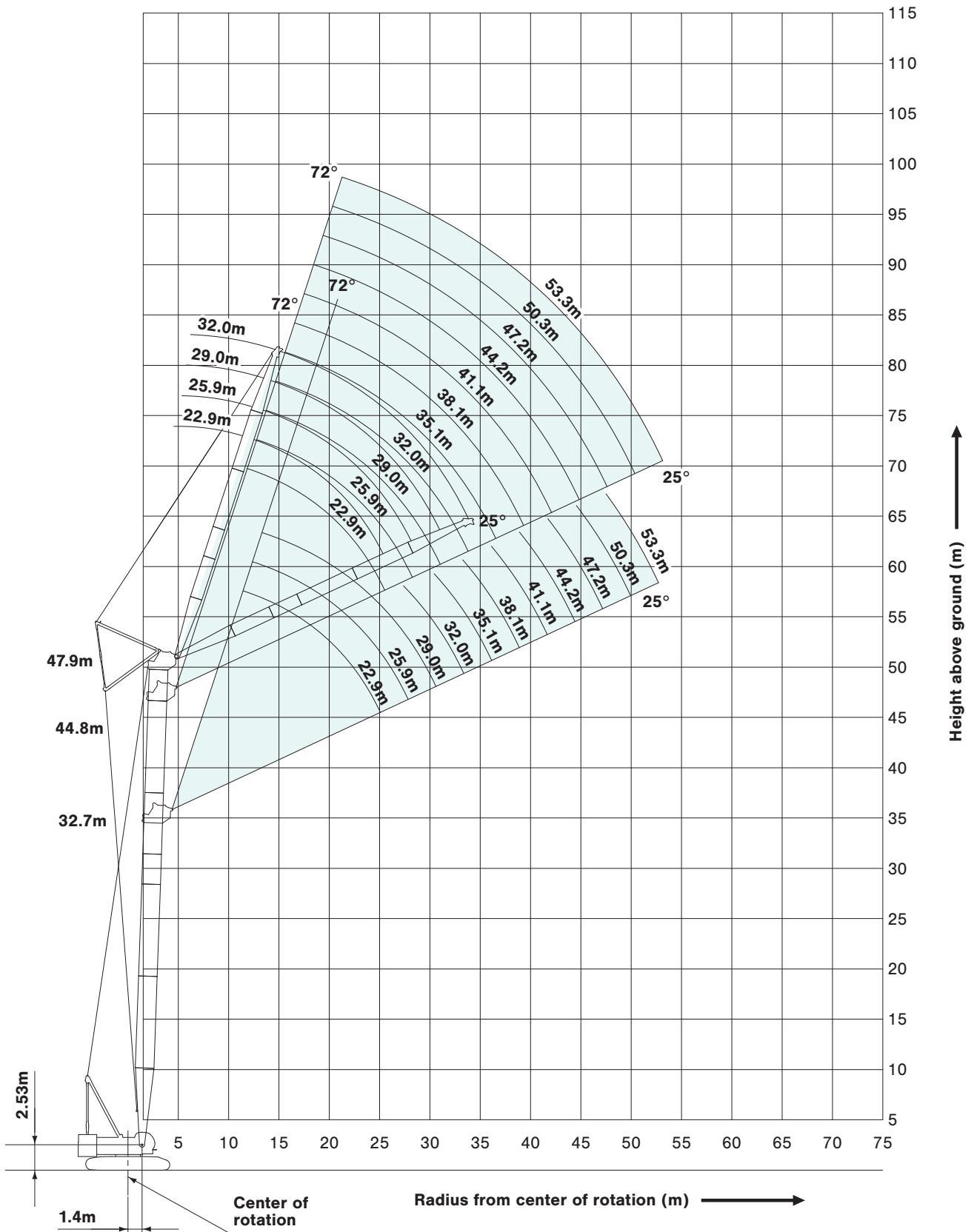

WORKING RANGES

Luffing Jib

Boom Angle: 78°

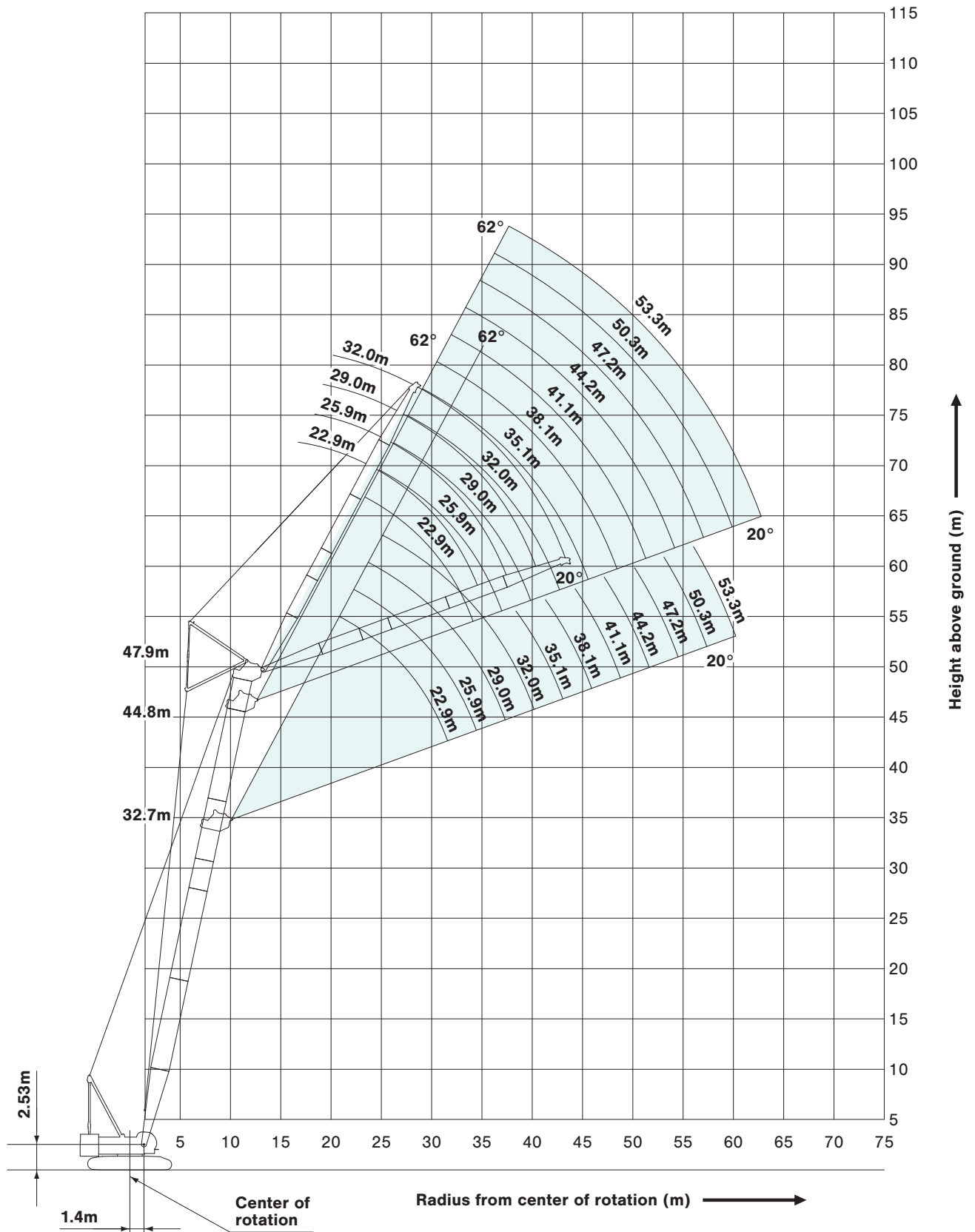

WORKING RANGES

Luffing Jib

Boom Angle: 68°

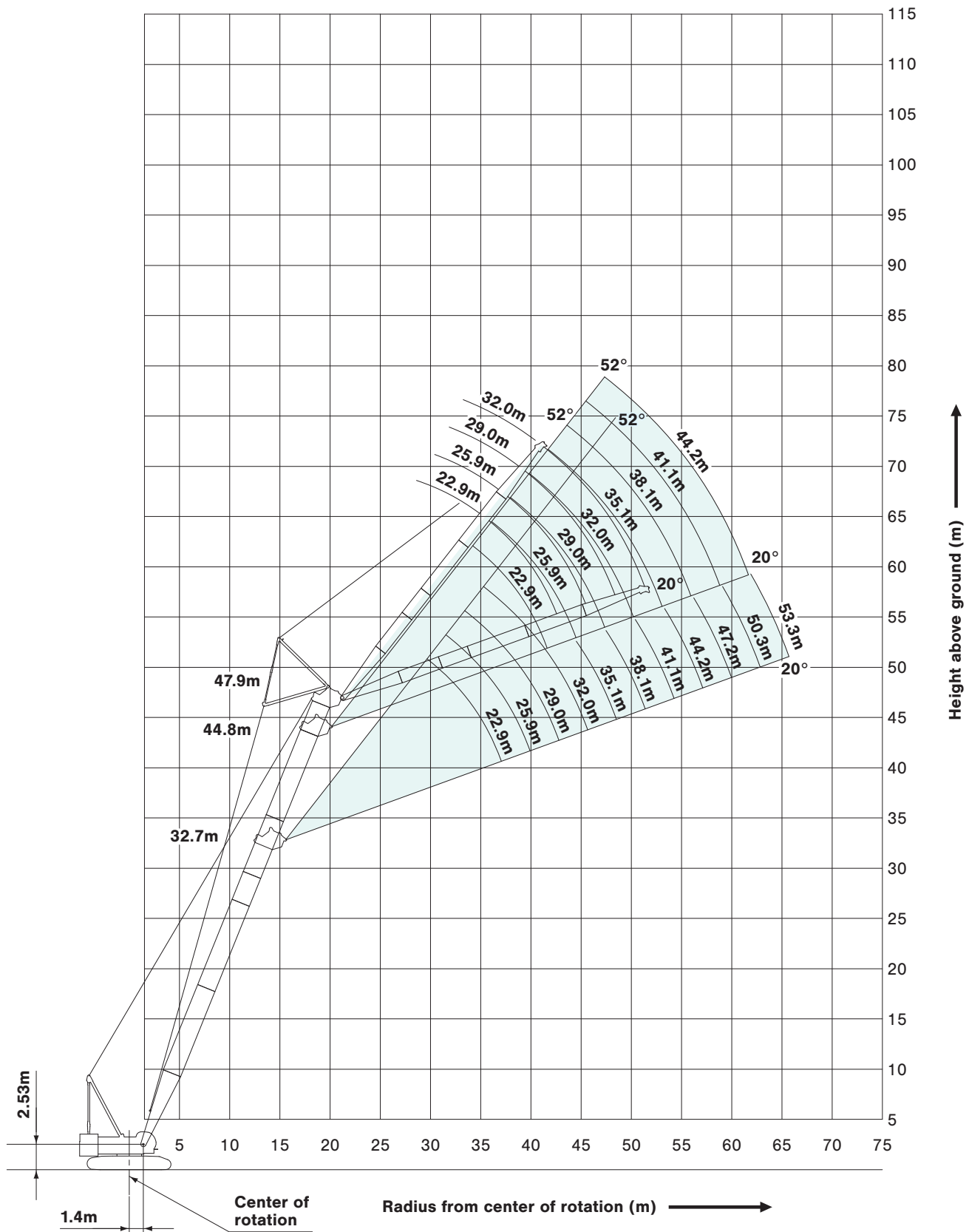

SUPPLEMENTAL DATA

- Ratings according to EN13000.
- Operating radius is the horizontal distance from centerline of rotation to a vertical line through the center of gravity of the load.
- Deduct weight of hook block (s), slings and all other load handling accessories from main boom ratings shown.
- Ratings shown are based on freely suspended loads and make no allowance for such factors as wind effect on lifted load, ground conditions, out-of-level, operating speeds or any other condition that could be detrimental to the safe operation of this equipment.

The operator, therefore, has the responsibility to judge the existing conditions and reduce lifted loads and operating speeds accordingly.

- Ratings are for operation on a firm and level surface, up to 1% gradient.
- At radii and boom lengths where no ratings are shown on chart, operation is not intended nor approved.
- Boom inserts and guy lines must be arranged as shown in the "operator's manual".
- Boom hoist reeving is 12 part line.
- Gantry must be in raised position for all conditions.
- Boom backstops are required for all boom lengths.
- The boom should be erected over the front of the crawlers, not laterally.
- Ratings inside of boxes are limited by strength of materials.
- The minimum rated load is 2.0 (ton).
- When erecting or lowering the boom length of 73.2 m (240 ft) or over, the blocks for erection must be placed under the front of the crawlers.

(Crane boom/long boom/luffing boom lifting)

- The total load that can be lifted is the value for weight of main hook block, slings, and all other load handling accessories deducted from crane boom/long boom/luffing boom ratings shown.

(Fixed jib lifting)

- The total load that can be lifted is the value for weight of jib hook block, slings, and all other load handling accessories deducted from fixed jib ratings shown.
- The availability of fixed jib mounting
 - On crane boom : Range 24.4 m to 61.0 m.
- Use of single part of line is not allowed on 12.2 m jib with 10 degrees offset angle on any boom length.

<Reference Information>

Main hoist loads

No. of Parts of Line	1	2	3	4	5
Maximum Loads (kN)	132	265	397	530	662
Maximum Loads (t)	13.5	27.0	40.5	54.0	67.5

No. of Parts of Line	6	7	8	9	10
Maximum Loads (kN)	794	927	1,059	1,192	1,324
Maximum Loads (t)	81.0	94.5	108.0	121.5	135.0

Auxiliary hoist loads

No. of Parts of Line	1	2
Maximum Loads (kN)	132	265
Maximum Loads (t)	13.5	27.0

Weight of hook block				
Hook Block	135 t	70 t	35 t	Ball Hook
Weight (t)	1.7	1.2	0.9	0.45

Operation of this equipment in excess of rated loads or disregard of instruction voids the warranty.

LIFTING CAPACITIES



Crane Boom Lifting Capacities

Counterweight: 55.0 t
Carbody Weight: 10.8 t

Unit: metric ton

Working radius (m)	Boom length (m)														Boom length (m)	Working radius (m)	
		15.2	18.3	21.3	24.4	27.4	30.5	33.5	36.6	39.6	42.7	45.7	48.8	51.8			
4.5	4.5m/135.0																4.5
5.0	131.1	5.1m/128.4	5.6m/117.2														5.0
6.0	110.4	110.1	109.6	6.1m/107.8	6.7m/95.1												6.0
7.0	95.1	94.8	93.3	91.1	89.3	7.2m/84.2	7.7m/75.3										7.0
8.0	79.5	79.9	79.1	77.4	75.9	74.6	72.4	8.2m/67.8	8.8m/61.7								8.0
9.0	67.7	68.8	68.5	67.2	66.0	64.9	62.5	61.5	60.0	9.3m/56.3	9.8m/51.8						9.0
10.0	58.4	59.0	59.0	58.8	58.3	57.4	56.5	55.0	53.6	52.2	50.9	10.4m/47.8	10.9m/44.2				10.0
12.0	44.3	45.7	45.6	45.4	45.2	45.2	45.1	44.9	44.1	43.0	42.0	41.0	40.0				12.0
14.0	33.5	37.1	37.0	36.8	36.6	36.5	36.5	36.3	36.2	36.1	35.6	34.7	33.9				14.0
16.0	14.8m/29.3	30.0	31.0	30.8	30.6	30.5	30.4	30.2	30.1	30.0	29.9	29.8	29.3				16.0
18.0		17.5m/24.8	26.6	26.4	26.2	26.1	26.0	25.8	25.7	25.6	25.4	25.3	25.2				18.0
20.0			21.7	23.0	22.8	22.7	22.6	22.4	22.3	22.2	22.0	21.9	21.7				20.0
22.0			20.1m/21.3	19.9	20.1	20.0	19.9	19.7	19.6	19.5	19.3	19.2	19.0				22.0
24.0				22.8m/18.5	18.0	17.9	17.7	17.5	17.4	17.3	17.1	17.0	16.8				24.0
26.0					25.4m/16.0	16.1	16.0	15.7	15.6	15.5	15.3	15.2	15.0				26.0
28.0						14.2	14.5	14.2	14.1	13.9	13.8	13.6	13.5				28.0
30.0							28.1m/14.1	13.2	12.9	12.8	12.7	12.5	12.3	12.2			30.0
32.0								30.7m/12.5	11.8	11.7	11.5	11.4	11.2	11.1			32.0
34.0									33.3m/10.9	10.8	10.6	10.4	10.3	10.1			34.0
36.0										9.7	9.8	9.6	9.4	9.2			36.0
38.0											8.9	8.8	8.7	8.5			38.0
40.0												38.6m/8.6	8.1	8.0	7.8		40.0
42.0													41.2m/7.5	7.4	7.2		42.0
44.0														43.9m/6.5	6.7		44.0
46.0															5.9		46.0
48.0																46.5m/5.7	48.0
Reeves	10	10	9	8	8	7	6	6	5	5	4	4	4	4	4	4	Reeves

Working radius (m)	Boom length (m)									Boom length (m)	Working radius (m)						
		54.9	57.9	61.0	64.0	67.1	70.1	73.2	76.2								
10.0	11.4m/40.1	11.9m/38.4										10.0					
12.0	39.1	38.2	12.5m/35.8	13.0m/33.4	13.5m/26.7							12.0					
14.0	33.2	32.5	31.7	30.9	26.7	14.1m/26.7	14.6m/24.4	15.1m/20.4				14.0					
16.0	28.7	28.1	27.4	26.7	26.3	25.7	22.7	19.4				16.0					
18.0	25.1	24.6	24.0	23.4	23.0	22.5	20.6	17.5				18.0					
20.0	21.6	21.5	21.2	20.7	20.4	19.9	18.8	15.8				20.0					
22.0	18.9	18.8	18.6	18.4	18.1	17.7	17.1	14.3				22.0					
24.0	16.7	16.6	16.4	16.2	16.2	15.8	15.4	13.0				24.0					
26.0	14.9	14.7	14.6	14.4	14.4	14.2	13.8	11.8				26.0					
28.0	13.4	13.2	13.1	12.9	12.8	12.7	12.4	10.7				28.0					
30.0	12.1	11.9	11.7	11.6	11.5	11.4	11.2	9.7				30.0					
32.0	10.9	10.8	10.6	10.4	10.4	10.2	10.0	8.8				32.0					
34.0	10.0	9.8	9.6	9.4	9.4	9.2	9.1	8.0				34.0					
36.0	9.1	8.9	8.8	8.6	8.5	8.4	8.2	7.2				36.0					
38.0	8.4	8.2	8.0	7.8	7.8	7.6	7.4	6.5				38.0					
40.0	7.7	7.5	7.3	7.1	7.1	6.9	6.7	5.8				40.0					
42.0	7.1	6.9	6.7	6.5	6.5	6.3	6.1	5.2				42.0					
44.0	6.5	6.4	6.2	6.0	5.9	5.7	5.5	4.6				44.0					
46.0	6.0	5.9	5.7	5.4	5.3	5.2	4.9	4.0				46.0					
48.0	5.3	5.4	5.2	4.9	4.9	4.7	4.4	3.5				48.0					
50.0	49.2m/4.8	4.7	4.7	4.5	4.4	4.2	4.0	2.9				50.0					
52.0		51.8m/4.1	4.2	4.1	4.0	3.8	3.6	2.4				52.0					
54.0			3.6	3.6	3.5	3.4	3.2					54.0					
56.0			54.4m/3.5	3.0	3.1	3.0	2.8					56.0					
58.0				57.1m/2.8	2.6	2.5	2.4					58.0					
60.0					59.7m/2.2	2.1						60.0					
Reeves	3	3	3	3	2	2	2	2	2	2	2	2	2	2	2	2	Reeves

Note: Ratings according to EN13000.

Ratings shown in are determined by the strength of the boom or other structural components.

Lifting capacities may vary depending on hook used or with/without auxiliary sheave.

Please refer rated chart in operator's cabin.

LIFTING CAPACITIES



Fixed Jib Lifting Capacities (Without Main Hook Block) (Jib Offset Angle : 10°)

Counterweight: 55.0 t
Carbody Weight: 10.8 t

Unit: metric ton

Boom length (m)		24.4				27.4				30.5				Boom length (m)	
Jib length (m)		12.2	18.3	24.4	30.5	12.2	18.3	24.4	30.5	12.2	18.3	24.4	30.5	Jib length (m)	
Working radius (m)	9.0	9.9m/26.8													9.0
	10.0	26.8				10.4m/26.8				10.9m/26.8					10.0
	12.0	26.7	19.2			26.8	12.5m/19.2			26.8	13.0m/19.2				12.0
	14.0	25.8	18.9	14.3m/9.9		26.1	19.0	14.9m/9.9		26.5	19.1	15.4m/9.8			14.0
	16.0	24.9	18.3	9.7	16.4m/5.9	25.3	18.5	9.8	16.9m/5.9	25.7	18.7	9.8	17.5m/5.9		16.0
	18.0	24.1	17.7	9.5	5.8	24.6	18.0	9.6	5.8	24.9	18.2	9.6	5.9		18.0
	20.0	22.9	16.8	9.2	5.6	23.3	17.4	9.4	5.7	23.2	17.7	9.4	5.7		20.0
	22.0	20.8	15.2	8.8	5.3	20.6	16.1	9.0	5.4	20.4	17.0	9.2	5.6		22.0
	24.0	18.6	13.9	8.4	5.0	18.4	14.8	8.6	5.2	18.2	15.6	8.8	5.3		24.0
	26.0	16.8	12.8	8.0	4.8	16.5	13.6	8.2	4.9	16.4	14.4	8.4	5.0		26.0
	28.0	15.2	11.9	7.7	4.5	15.0	12.6	7.9	4.7	14.9	13.3	8.1	4.8		28.0
	30.0	13.9	11.1	7.4	4.3	13.7	11.8	7.6	4.5	13.5	12.4	7.8	4.6		30.0
	32.0	12.8	10.4	7.2	4.2	12.6	11.0	7.4	4.3	12.4	11.7	7.6	4.4		32.0
	34.0	11.2	9.7	6.9	4.0	11.6	10.4	7.1	4.1	11.4	11.0	7.3	4.2		34.0
	36.0		9.2	6.7	3.8	10.4	9.8	6.9	3.9	10.6	10.4	7.1	4.1		36.0
	38.0		8.7	6.5	3.7		9.3	6.7	3.8	9.7	9.8	6.9	3.9		38.0
	40.0		8.3	6.3	3.5		8.8	6.5	3.7	8.4	9.3	6.7	3.8		40.0
	42.0			6.2	3.4		8.4	6.4	3.5		8.7	6.5	3.7		42.0
	44.0			6.1	3.3			6.2	3.4		7.8	6.4	3.5		44.0
	46.0			6.0	3.2			6.1	3.3			6.2	3.4		46.0
48.0				3.1			6.0	3.2			6.1	3.3		48.0	
50.0				3.1				3.1			6.0	3.2		50.0	
52.0								3.1				3.2		52.0	
54.0								3.0				3.1		54.0	
56.0												3.0		56.0	
Reeves		2	2	1	1	2	2	1	1	2	2	1	1	Reeves	

Boom length (m)		33.5				36.6				39.6				Boom length (m)	
Jib length (m)		12.2	18.3	24.4	30.5	12.2	18.3	24.4	30.5	12.2	18.3	24.4	30.5	Jib length (m)	
Working radius (m)	10.0	11.5m/26.8													10.0
	12.0	26.8	13.5m/19.2			26.8				12.5m/26.8					12.0
	14.0	26.8	19.1	15.9m/9.9		26.8	14.1m/19.2			26.8	14.6m/19.2				14.0
	16.0	26.0	18.8	9.9		26.3	18.9	16.4m/9.9		26.5	19.0	17.0m/9.9			16.0
	18.0	25.3	18.4	9.7	5.9	25.6	18.6	9.7	18.5m/5.9	25.8	18.7	9.8	19.1m/5.9		18.0
	20.0	23.0	17.9	9.5	5.7	22.8	18.1	9.6	5.8	22.7	18.3	9.6	5.8		20.0
	22.0	20.3	17.4	9.3	5.6	20.1	17.6	9.4	5.7	20.0	17.8	9.5	5.7		22.0
	24.0	18.1	16.4	9.0	5.4	17.9	17.2	9.1	5.5	17.7	17.4	9.3	5.6		24.0
	26.0	16.2	15.1	8.6	5.1	16.0	15.9	8.8	5.3	15.9	16.1	9.0	5.4		26.0
	28.0	14.7	14.0	8.3	4.9	14.5	14.7	8.5	5.0	14.3	14.6	8.7	5.1		28.0
	30.0	13.4	13.1	8.0	4.7	13.2	13.4	8.2	4.8	13.0	13.2	8.4	4.9		30.0
	32.0	12.3	12.3	7.7	4.5	12.0	12.3	7.9	4.6	11.9	12.1	8.1	4.7		32.0
	34.0	11.3	11.5	7.5	4.3	11.1	11.3	7.7	4.4	10.9	11.1	7.8	4.6		34.0
	36.0	10.4	10.6	7.3	4.2	10.2	10.4	7.4	4.3	10.0	10.2	7.6	4.4		36.0
	38.0	9.7	9.8	7.1	4.0	9.4	9.6	7.2	4.1	9.3	9.5	7.4	4.2		38.0
	40.0	8.9	9.1	6.9	3.9	8.7	8.9	7.0	4.0	8.6	8.8	7.2	4.1		40.0
	42.0	7.8	8.5	6.7	3.8	8.1	8.3	6.9	3.9	8.0	8.1	7.0	4.0		42.0
	44.0		8.0	6.5	3.6	7.1	7.8	6.7	3.7	7.4	7.6	6.8	3.8		44.0
	46.0		7.3	6.4	3.5		7.3	6.5	3.6	6.5	7.1	6.7	3.7		46.0
	48.0		6.4	6.3	3.4		6.6	6.4	3.5		6.6	6.5	3.6		48.0
50.0			6.1	3.3		5.8	6.3	3.4		6.0	6.4	3.5		50.0	
52.0			6.0	3.2			6.2	3.3		5.4	6.0	3.4		52.0	
54.0			5.4	3.2			5.6	3.3			5.7	3.3		54.0	
56.0				3.1			5.0	3.2			5.1	3.3		56.0	
58.0				3.0				3.1			4.5	3.2		58.0	
60.0				2.9				3.1				3.1		60.0	
62.0								3.0				3.1		62.0	
64.0												3.0		64.0	
Reeves		2	2	1	1	2	2	1	1	2	2	1	1	Reeves	

Note: Ratings according to EN13000.

Ratings shown in are determined by the strength of the boom or other structural components.

12.2 m jib length with offset angle 10 degrees, one part of line on hook is not allowed to use.

Lifting capacities may vary depending on hook used or with/without auxiliary sheave.

Please refer rated chart in operator's cabin.



Fixed Jib Lifting Capacities (Without Main Hook Block)

(Jib Offset Angle : 10°)

Counterweight: 55.0 t
Carbody Weight: 10.8 t

Unit: metric ton

Boom length (m)	42.7				45.7				48.8				Boom length (m)
Jib length (m)	12.2	18.3	24.4	30.5	12.2	18.3	24.4	30.5	12.2	18.3	24.4	30.5	Jib length (m)
12.0	13.0m/26.8				13.6m/26.8								12.0
14.0	26.8	15.1m/19.2			26.8	15.7m/19.1			14.1m/26.8				14.0
16.0	26.8	19.1	17.5m/9.9		26.8	19.1			26.8	16.2m/19.2			16.0
18.0	26.0	18.8	9.8	19.6m/5.9	25.8	18.9	9.9		25.7	18.9	18.6m/9.9		18.0
20.0	22.5	18.4	9.7	5.9	22.4	18.6	9.7	20.1m/5.9	22.2	18.7	9.8	20.6m/5.9	20.0
22.0	19.8	18.0	9.5	5.7	19.6	18.1	9.6	5.8	19.5	18.3	9.6	5.8	22.0
24.0	17.6	17.6	9.4	5.6	17.4	17.6	9.4	5.7	17.2	17.5	9.5	5.7	24.0
26.0	15.7	16.0	9.1	5.5	15.5	15.8	9.3	5.5	15.4	15.7	9.3	5.6	26.0
28.0	14.2	14.4	8.8	5.2	14.0	14.2	9.0	5.3	13.8	14.1	9.1	5.4	28.0
30.0	12.9	13.1	8.5	5.0	12.7	12.9	8.7	5.1	12.5	12.8	8.8	5.2	30.0
32.0	11.7	11.9	8.2	4.8	11.5	11.7	8.4	4.9	11.4	11.6	8.5	5.0	32.0
34.0	10.7	10.9	8.0	4.7	10.5	10.7	8.1	4.7	10.4	10.6	8.3	4.8	34.0
36.0	9.9	10.1	7.8	4.5	9.7	9.9	7.9	4.6	9.5	9.7	8.1	4.7	36.0
38.0	9.1	9.3	7.6	4.3	8.9	9.1	7.7	4.4	8.7	8.9	7.8	4.5	38.0
40.0	8.4	8.6	7.4	4.2	8.2	8.4	7.5	4.3	8.0	8.2	7.6	4.4	40.0
42.0	7.8	8.0	7.2	4.1	7.6	7.8	7.3	4.2	7.4	7.6	7.4	4.2	42.0
44.0	7.2	7.4	7.0	3.9	7.0	7.2	7.1	4.0	6.9	7.1	7.3	4.1	44.0
46.0	6.7	6.9	6.8	3.8	6.5	6.7	7.0	3.9	6.4	6.6	6.8	4.0	46.0
48.0	5.9	6.5	6.7	3.7	5.9	6.2	6.5	3.8	5.9	6.1	6.4	3.9	48.0
50.0	5.2	6.0	6.3	3.6	5.3	5.8	6.1	3.7	5.3	5.7	5.9	3.8	50.0
52.0		5.4	5.9	3.5	4.6	5.3	5.7	3.6	4.7	5.2	5.5	3.7	52.0
54.0		4.9	5.5	3.4		4.8	5.3	3.5	4.1	4.8	5.2	3.6	54.0
56.0		4.3	5.1	3.3		4.3	5.0	3.4	3.5	4.3	4.8	3.5	56.0
58.0			4.6	3.3		3.7	4.5	3.3		3.8	4.5	3.4	58.0
60.0			4.1	3.2			4.1	3.3		3.3	4.0	3.3	60.0
62.0				3.1			3.6	3.2			3.6	3.3	62.0
64.0				3.1			3.2	3.1			3.2	3.2	64.0
66.0				3.0				3.1			2.8	3.1	66.0
68.0								2.9				2.9	68.0
70.0								2.5				2.5	70.0
72.0												2.1	72.0
Reeves	2	2	1	1	2	2	1	1	2	2	1	1	Reeves

Boom length (m)	51.8				54.9				57.9				Boom length (m)
Jib length (m)	12.2	18.3	24.4	30.5	12.2	18.3	24.4	30.5	12.2	18.3	24.4	30.5	Jib length (m)
14.0	14.6m/26.8				15.2m/26.8				15.7m/24.0				14.0
16.0	26.8	16.7m/19.1			26.8	17.2m/19.1			24.0	17.8m/19.1			16.0
18.0	25.6	19.0	19.1m/9.9		25.4	19.0	19.6m/9.8		23.5	19.1			18.0
20.0	22.1	18.8	9.8	21.2m/5.9	21.9	18.8	9.8	21.7m/5.9	21.7	18.9	20.1m/9.9		20.0
22.0	19.3	18.4	9.6	5.8	19.1	18.6	9.7	5.9	19.0	18.7	9.7	22.2m/5.9	22.0
24.0	17.1	17.4	9.5	5.7	16.9	17.2	9.6	5.8	16.7	17.0	9.6	5.8	24.0
26.0	15.2	15.5	9.4	5.6	15.0	15.3	9.4	5.6	14.9	15.2	9.5	5.7	26.0
28.0	13.7	13.9	9.2	5.5	13.5	13.8	9.3	5.5	13.3	13.6	9.3	5.6	28.0
30.0	12.4	12.6	8.9	5.3	12.2	12.4	9.1	5.4	12.0	12.2	9.2	5.5	30.0
32.0	11.2	11.5	8.7	5.1	11.0	11.3	8.8	5.2	10.8	11.1	8.9	5.3	32.0
34.0	10.2	10.4	8.4	4.9	10.0	10.3	8.6	5.0	9.8	10.1	8.7	5.1	34.0
36.0	9.3	9.6	8.2	4.8	9.1	9.4	8.3	4.8	9.0	9.2	8.5	4.9	36.0
38.0	8.6	8.8	8.0	4.6	8.4	8.6	8.1	4.7	8.2	8.4	8.2	4.8	38.0
40.0	7.9	8.1	7.8	4.5	7.7	7.9	7.9	4.5	7.5	7.7	8.0	4.6	40.0
42.0	7.3	7.5	7.6	4.3	7.0	7.3	7.6	4.4	6.9	7.1	7.4	4.5	42.0
44.0	6.7	6.9	7.2	4.2	6.5	6.7	7.0	4.3	6.3	6.5	6.8	4.4	44.0
46.0	6.2	6.4	6.7	4.1	6.0	6.2	6.5	4.2	5.8	6.0	6.3	4.2	46.0
48.0	5.7	5.9	6.2	4.0	5.5	5.7	6.0	4.0	5.3	5.5	5.8	4.1	48.0
50.0	5.2	5.5	5.8	3.9	5.0	5.3	5.6	3.9	4.8	5.1	5.4	4.0	50.0
52.0	4.7	5.1	5.4	3.8	4.5	4.8	5.2	3.8	4.3	4.6	5.0	3.9	52.0
54.0	4.1	4.6	5.0	3.7	4.0	4.4	4.8	3.7	3.8	4.2	4.7	3.8	54.0
56.0	3.6	4.2	4.7	3.6	3.5	4.0	4.5	3.7	3.4	3.8	4.3	3.7	56.0
58.0	3.1	3.7	4.3	3.5	3.0	3.5	4.1	3.6	2.9	3.4	3.9	3.6	58.0
60.0		3.3	3.9	3.4	2.6	3.1	3.7	3.5	2.5	3.0	3.5	3.6	60.0
62.0		2.9	3.5	3.3		2.7	3.3	3.4	2.1	2.6	3.2	3.3	62.0
64.0		2.4	3.1	3.3		2.4	3.0	3.2		2.3	2.8	3.0	64.0
66.0			2.8	3.1			2.6	2.9			2.5	2.7	66.0
68.0			2.4	2.8			2.3	2.6			2.2	2.4	68.0
70.0				2.4				2.3				2.1	70.0
Reeves	2	2	1	1	2	2	1	1	2	2	1	1	Reeves

Note: Ratings according to EN13000.

Ratings shown in are determined by the strength of the boom or other structural components.

12.2 m jib length with offset angle 10 degrees, one part of line on hook is not allowed to use.

Lifting capacities may vary depending on hook used or with/without auxiliary sheave.

Please refer rated chart in operator's cabin.

LIFTING CAPACITIES



Fixed Jib Lifting Capacities (Without Main Hook Block) (Jib Offset Angle : 10°)

Counterweight: 55.0 t
Carbody Weight: 10.8 t

Unit: metric ton

Boom length (m)		61.0												Boom length (m)		
Jib length (m)		12.2	18.3	24.4	30.5									Jib length (m)		
Working radius (m)	16.0	16.2m/21.2														16.0
	18.0	20.7	18.3m/19.1													18.0
	20.0	20.3	18.9	20.7m/9.9												20.0
	22.0	18.7	18.7	9.8	22.8m/5.9											22.0
	24.0	16.6	16.7	9.6	5.8											24.0
	26.0	14.8	14.9	9.5	5.7											26.0
	28.0	13.2	13.4	9.4	5.6											28.0
	30.0	11.9	12.1	9.3	5.5											30.0
	32.0	10.7	11.0	9.1	5.3											32.0
	34.0	9.7	10.0	8.8	5.2											34.0
	36.0	8.8	9.1	8.6	5.0											36.0
	38.0	8.1	8.3	8.4	4.9											38.0
	40.0	7.4	7.6	7.9	4.7											40.0
	42.0	6.7	7.0	7.3	4.6											42.0
	44.0	6.2	6.4	6.7	4.4											44.0
	46.0	5.6	5.9	6.2	4.3											46.0
	48.0	5.1	5.3	5.7	4.2											48.0
	50.0	4.6	4.9	5.3	4.1											50.0
	52.0	4.1	4.4	4.9	4.0											52.0
	54.0	3.7	4.0	4.5	3.9											54.0
56.0	3.3	3.6	4.1	3.8											56.0	
58.0	2.8	3.2	3.7	3.7											58.0	
60.0	2.4	2.8	3.3	3.5											60.0	
62.0	2.1	2.5	3.0	3.1											62.0	
64.0		2.1	2.7	2.8											64.0	
66.0			2.3	2.5											66.0	
68.0			2.0	2.2											68.0	
Reeves		2	2	1	1											Reeves

Note: Ratings according to EN13000.

Ratings shown in are determined by the strength of the boom or other structural components.

12.2 m jib length with offset angle 10 degrees, one part of line on hook is not allowed to use.

Lifting capacities may vary depending on hook used or with/without auxiliary sheave.

Please refer rated chart in operator's cabin.



Fixed Jib Lifting Capacities (Without Main Hook Block)

(Jib Offset Angle : 30°)

Counterweight: 55.0 t
Carbody Weight: 10.8 t

Unit: metric ton

Boom length (m)		24.4				27.4				30.5				Boom length (m)	
Jib length (m)		12.2	18.3	24.4	30.5	12.2	18.3	24.4	30.5	12.2	18.3	24.4	30.5	Jib length (m)	
Working radius (m)	12.0	13.5m/18.2													12.0
	14.0	17.8				14.1m/18.2				14.6m/18.2					14.0
	16.0	16.4	17.5m/12.4			16.9				17.3					16.0
	18.0	15.2	12.1			15.7	12.4			16.2	18.5m/12.5				18.0
	20.0	14.3	11.2	21.4m/7.4		14.7	11.5	21.9m/7.5		15.2	11.8				20.0
	22.0	13.4	10.5	7.4		13.9	10.8	7.5		14.3	11.1	22.4m/7.5			22.0
	24.0	12.7	9.8	7.2	25.3m/4.1	13.2	10.1	7.3	25.8m/4.0	13.6	10.4	7.3			24.0
	26.0	12.1	9.2	7.0	4.0	12.5	9.6	7.1	4.0	13.0	9.9	7.1	26.3m/4.1		26.0
	28.0	11.6	8.8	6.8	3.8	12.0	9.1	6.9	3.9	12.4	9.4	6.9	3.9		28.0
	30.0	11.1	8.3	6.5	3.7	11.5	8.6	6.7	3.8	11.9	8.9	6.8	3.8		30.0
	32.0	10.8	7.9	6.2	3.6	11.1	8.2	6.4	3.6	11.5	8.5	6.5	3.7		32.0
	34.0	10.5	7.6	5.9	3.5	10.8	7.9	6.1	3.5	11.1	8.2	6.2	3.6		34.0
	36.0		7.3	5.6	3.4	10.6	7.6	5.8	3.4	10.7	7.9	6.0	3.5		36.0
	38.0		7.1	5.4	3.3	9.2	7.4	5.6	3.3	9.9	7.6	5.7	3.4		38.0
	40.0		7.0	5.2	3.2		7.1	5.4	3.2	8.8	7.4	5.5	3.3		40.0
	42.0			5.0	3.1		7.0	5.2	3.2		7.2	5.3	3.2		42.0
	44.0			4.9	3.1		6.9	5.0	3.1		7.0	5.2	3.2		44.0
	46.0			4.8	3.0			4.9	3.0		6.9	5.0	3.1		46.0
	48.0				3.0			4.8	3.0			4.9	3.0		48.0
	50.0				2.9			4.7	3.0			4.8	3.0		50.0
52.0				2.9				2.9			4.7	3.0		52.0	
54.0								2.9				2.9		54.0	
56.0								2.9				2.9		56.0	
58.0												2.9		58.0	
Reeves	2	1	1	1	2	1	1	1	2	1	1	1	1	Reeves	

Boom length (m)		33.5				36.6				39.6				Boom length (m)	
Jib length (m)		12.2	18.3	24.4	30.5	12.2	18.3	24.4	30.5	12.2	18.3	24.4	30.5	Jib length (m)	
Working radius (m)	14.0	15.1m/18.2				15.6m/18.2									14.0
	16.0	17.7				18.0				16.2m/18.3					16.0
	18.0	16.5	19.0m/12.5			16.9	19.6m/12.4			17.2					18.0
	20.0	15.6	12.1			16.0	12.3			16.3	20.1m/12.5				20.0
	22.0	14.7	11.3	23.0m/7.5		15.1	11.6	23.5m/7.5		15.5	11.8				22.0
	24.0	14.0	10.7	7.4		14.4	10.9	7.5		14.7	11.2	7.5			24.0
	26.0	13.4	10.1	7.2	26.9m/4.1	13.7	10.4	7.3	27.4m/4.1	14.1	10.6	7.3	27.9m/4.0		26.0
	28.0	12.8	9.6	7.0	4.0	13.2	9.9	7.1	4.0	13.5	10.1	7.1	4.0		28.0
	30.0	12.3	9.2	6.8	3.8	12.7	9.4	6.9	3.9	13.0	9.7	7.0	3.9		30.0
	32.0	11.9	8.8	6.7	3.7	12.2	9.0	6.8	3.8	12.2	9.3	6.8	3.8		32.0
	34.0	11.5	8.4	6.4	3.6	11.3	8.7	6.6	3.7	11.1	8.9	6.7	3.7		34.0
	36.0	10.6	8.1	6.1	3.5	10.4	8.3	6.3	3.6	10.2	8.6	6.4	3.6		36.0
	38.0	9.8	7.8	5.9	3.4	9.6	8.1	6.1	3.5	9.4	8.3	6.2	3.5		38.0
	40.0	9.1	7.6	5.7	3.3	8.9	7.8	5.8	3.4	8.7	8.0	6.0	3.4		40.0
	42.0	8.2	7.4	5.5	3.3	8.2	7.6	5.6	3.3	8.1	7.8	5.8	3.4		42.0
	44.0		7.2	5.3	3.2	7.5	7.4	5.5	3.2	7.5	7.6	5.6	3.3		44.0
	46.0		7.0	5.2	3.1		7.2	5.3	3.2	6.8	7.4	5.4	3.2		46.0
	48.0		6.9	5.0	3.1		7.0	5.2	3.1	6.0	6.9	5.3	3.2		48.0
	50.0			4.9	3.0		6.4	5.0	3.1		6.4	5.1	3.1		50.0
	52.0			4.8	3.0		5.5	4.9	3.0		5.9	5.0	3.1		52.0
54.0			4.7	2.9			4.8	3.0		5.1	4.9	3.0		54.0	
56.0				2.9			4.8	2.9			4.8	3.0		56.0	
58.0				2.9			4.7	2.9			4.8	2.9		58.0	
60.0				2.9				2.9			4.3	2.9		60.0	
62.0								2.9				2.9		62.0	
64.0								2.9				2.9		64.0	
66.0												2.9		66.0	
Reeves	2	1	1	1	2	1	1	1	2	1	1	1	1	Reeves	

Note: Ratings according to EN13000.

Ratings shown in are determined by the strength of the boom or other structural components.

Lifting capacities may vary depending on hook used or with/without auxiliary sheave.

Please refer rated chart in operator's cabin.

LIFTING CAPACITIES



Fixed Jib Lifting Capacities (Without Main Hook Block) (Jib Offset Angle : 30°)

Counterweight: 55.0 t
Carbody Weight: 10.8 t

Unit: metric ton

Boom length (m)		42.7				45.7				48.8				Boom length (m)	
Jib length (m)		12.2	18.3	24.4	30.5	12.2	18.3	24.4	30.5	12.2	18.3	24.4	30.5	Jib length (m)	
Working radius (m)	16.0	16.7m/18.2				17.2m/18.2				17.8m/18.1				16.0	
	18.0	17.5				17.8				18.1				18.0	
	20.0	16.6	20.6m/12.5			16.9	21.2m/12.5			17.2	21.7m/12.5			20.0	
	22.0	15.8	12.0			16.1	12.2			16.4	12.4			22.0	
	24.0	15.1	11.4	24.5m/7.5		15.4	11.6	25.1m/7.5		15.7	11.8	25.6m/7.6		24.0	
	26.0	14.4	10.8	7.4		14.7	11.0	7.4		15.0	11.2	7.5		26.0	
	28.0	13.8	10.3	7.2	28.5m/4.0	14.2	10.5	7.3	29.0m/4.1	14.3	10.7	7.3	29.5m/4.0	28.0	
	30.0	13.2	9.9	7.0	3.9	13.0	10.1	7.1	4.0	12.9	10.3	7.2	4.0	30.0	
	32.0	12.0	9.5	6.9	3.8	11.9	9.7	7.0	3.9	11.7	9.9	7.0	3.9	32.0	
	34.0	11.0	9.1	6.8	3.7	10.8	9.3	6.8	3.8	10.7	9.5	6.9	3.8	34.0	
	36.0	10.1	8.8	6.6	3.6	9.9	9.0	6.7	3.7	9.8	9.2	6.7	3.7	36.0	
	38.0	9.3	8.5	6.3	3.6	9.1	8.7	6.5	3.6	9.0	8.9	6.6	3.6	38.0	
	40.0	8.6	8.2	6.1	3.5	8.4	8.4	6.3	3.5	8.3	8.6	6.4	3.5	40.0	
	42.0	8.0	8.0	5.9	3.4	7.8	8.2	6.1	3.4	7.6	8.1	6.2	3.5	42.0	
	44.0	7.4	7.7	5.7	3.3	7.2	7.6	5.9	3.4	7.1	7.5	6.0	3.4	44.0	
	46.0	6.9	7.2	5.6	3.3	6.7	7.1	5.7	3.3	6.5	6.9	5.8	3.3	46.0	
	48.0	6.2	6.7	5.4	3.2	6.2	6.6	5.5	3.2	6.0	6.4	5.6	3.3	48.0	
	50.0	5.4	6.3	5.3	3.1	5.5	6.1	5.4	3.2	5.5	6.0	5.5	3.2	50.0	
	52.0		5.9	5.1	3.1	4.8	5.7	5.3	3.1	4.9	5.6	5.4	3.2	52.0	
	54.0		5.4	5.0	3.0		5.3	5.1	3.1	4.3	5.2	5.2	3.1	54.0	
	56.0		4.7	4.9	3.0		4.8	5.0	3.0	3.7	4.8	5.1	3.1	56.0	
	58.0			4.8	3.0		4.2	4.9	3.0		4.3	4.7	3.0	58.0	
	60.0			4.5	2.9			4.5	3.0		3.7	4.4	3.0	60.0	
	62.0			4.0	2.9			4.0	2.9		3.2	4.0	3.0	62.0	
64.0				2.9			3.5	2.9			3.6	2.9	64.0		
66.0				2.9			3.0	2.9			3.1	2.9	66.0		
68.0				2.9				2.9			2.6	2.9	68.0		
70.0								2.9				2.9	70.0		
72.0												2.5	72.0		
74.0												2.1	74.0		
Reeves	2	1	1	1	2	1	1	1	2	1	1	1	Reeves		

Boom length (m)		51.8				54.9				57.9				Boom length (m)	
Jib length (m)		12.2	18.3	24.4	30.5	12.2	18.3	24.4	30.5	12.2	18.3	24.4	30.5	Jib length (m)	
Working radius (m)	18.0	18.3m/18.2				18.8m/18.2				19.4m/18.1				18.0	
	20.0	17.4				17.7				17.9				20.0	
	22.0	16.7	22.2m/12.5			16.9	22.7m/12.5			17.1	23.3m/12.5			22.0	
	24.0	15.9	11.9			16.2	12.1			16.4	12.3			24.0	
	26.0	15.3	11.4	26.1m/7.5		15.6	11.6	26.7m/7.5		15.5	11.7	27.2m/7.5		26.0	
	28.0	14.2	10.9	7.3		14.0	11.1	7.4		13.9	11.3	7.4		28.0	
	30.0	12.8	10.5	7.2	30.1m/4.0	12.6	10.7	7.2	30.6m/4.1	12.5	10.8	7.3	31.1m/4.0	30.0	
	32.0	11.6	10.1	7.1	3.9	11.4	10.3	7.1	4.0	11.3	10.4	7.1	4.0	32.0	
	34.0	10.6	9.7	6.9	3.8	10.4	9.9	7.0	3.9	10.2	10.1	7.0	3.9	34.0	
	36.0	9.7	9.4	6.8	3.7	9.5	9.6	6.8	3.8	9.3	9.7	6.9	3.8	36.0	
	38.0	8.9	9.1	6.7	3.7	8.7	9.2	6.7	3.7	8.5	9.1	6.8	3.7	38.0	
	40.0	8.1	8.6	6.5	3.6	8.0	8.5	6.6	3.6	7.8	8.3	6.7	3.6	40.0	
	42.0	7.5	8.0	6.3	3.5	7.3	7.8	6.4	3.5	7.1	7.7	6.5	3.6	42.0	
	44.0	6.9	7.4	6.1	3.4	6.7	7.2	6.2	3.5	6.6	7.1	6.3	3.5	44.0	
	46.0	6.4	6.8	5.9	3.4	6.2	6.6	6.0	3.4	6.0	6.5	6.1	3.4	46.0	
	48.0	5.9	6.3	5.8	3.3	5.7	6.1	5.9	3.3	5.6	6.0	6.0	3.4	48.0	
	50.0	5.5	5.9	5.6	3.2	5.3	5.7	5.7	3.3	5.1	5.6	5.8	3.3	50.0	
	52.0	4.9	5.4	5.5	3.2	4.7	5.3	5.6	3.2	4.6	5.1	5.4	3.2	52.0	
	54.0	4.4	5.1	5.3	3.1	4.2	4.9	5.2	3.2	4.1	4.7	5.0	3.2	54.0	
	56.0	3.8	4.7	5.0	3.1	3.7	4.5	4.8	3.1	3.6	4.4	4.7	3.2	56.0	
	58.0	3.3	4.2	4.6	3.1	3.2	4.1	4.5	3.1	3.2	3.9	4.3	3.1	58.0	
	60.0		3.8	4.3	3.0	2.7	3.6	4.1	3.0	2.7	3.5	4.0	3.1	60.0	
	62.0		3.3	3.9	3.0		3.2	3.7	3.0	2.3	3.1	3.6	3.0	62.0	
	64.0		2.8	3.5	2.9		2.8	3.4	3.0		2.7	3.2	3.0	64.0	
66.0			3.1	2.9		2.3	3.0	2.9		2.3	2.9	3.0	66.0		
68.0			2.7	2.9			2.6	2.9			2.5	2.9	68.0		
70.0			2.3	2.9			2.2	2.7			2.2	2.6	70.0		
72.0				2.5				2.4				2.3	72.0		
74.0				2.2				2.1					74.0		
Reeves	2	1	1	1	2	1	1	1	2	1	1	1	Reeves		

Note: Ratings according to EN13000.

Ratings shown in are determined by the strength of the boom or other structural components.

Lifting capacities may vary depending on hook used or with/without auxiliary sheave.

Please refer rated chart in operator's cabin.



Fixed Jib Lifting Capacities (Without Main Hook Block) (Jib Offset Angle : 30°)

Counterweight: 55.0 t
Carbody Weight: 10.8 t

Unit: metric ton

Boom length (m)		61.0												Boom length (m)		
Jib length (m)		12.2	18.3	24.4	30.5									Jib length (m)		
Working radius (m)	18.0	19.9m/18.1														18.0
	20.0	18.1														20.0
	22.0	17.3	23.8m/12.4													22.0
	24.0	16.7	12.4													24.0
	26.0	15.3	11.9	27.7m/7.5												26.0
	28.0	13.8	11.4	7.5												28.0
	30.0	12.4	11.0	7.3	31.6m/4.0											30.0
	32.0	11.2	10.6	7.2	4.0											32.0
	34.0	10.1	10.2	7.1	3.9											34.0
	36.0	9.2	9.8	6.9	3.8											36.0
	38.0	8.4	9.0	6.8	3.7											38.0
	40.0	7.7	8.2	6.7	3.7											40.0
	42.0	7.0	7.6	6.6	3.6											42.0
	44.0	6.4	7.0	6.4	3.5											44.0
	46.0	5.9	6.4	6.2	3.5											46.0
	48.0	5.4	5.9	6.1	3.4											48.0
	50.0	4.9	5.4	5.8	3.3											50.0
	52.0	4.4	5.0	5.3	3.3											52.0
	54.0	3.9	4.6	4.9	3.2											54.0
	56.0	3.5	4.2	4.6	3.2											56.0
	58.0	3.1	3.8	4.2	3.1											58.0
	60.0	2.7	3.4	3.8	3.1											60.0
	62.0	2.2	3.0	3.4	3.1											62.0
	64.0		2.6	3.1	3.0											64.0
66.0		2.3	2.7	3.0											66.0	
68.0			2.4	2.7											68.0	
70.0			2.1	2.4											70.0	
72.0				2.2											72.0	
	Reeves	2	1	1	1										Reeves	

Note: Ratings according to EN13000.

Ratings shown in are determined by the strength of the boom or other structural components.

Lifting capacities may vary depending on hook used or with/without auxiliary sheave.

Please refer rated chart in operator's cabin.

LIFTING CAPACITIES



Long Boom Lifting Capacities

Counterweight: 55.0 t
Carbody Weight: 10.8 t

Unit: metric ton

Working radius (m) \ Boom length (m)	51.8	54.9	57.9	61.0	64.0	67.1	70.1	73.2	76.2	79.2	82.3	Working radius (m) \ Boom length (m)
10.0	10.6m/44.3	11.2m/40.5	11.7m/38.2									10.0
12.0	41.6	40.1	37.8	12.2m/35.3	12.7m/33.5	13.3m/27.0	13.8m/26.0					12.0
14.0	36.1	36.0	35.5	33.4	32.4	27.0	25.8	14.3m/22.3	14.9m/19.4	15.4m/17.0	15.9m/15.0	14.0
16.0	30.1	30.0	29.8	29.7	29.6	27.0	23.7	20.8	18.5	16.6	14.9	16.0
18.0	25.6	25.6	25.4	25.2	25.1	25.2	22.0	19.2	17.1	15.3	13.7	18.0
20.0	22.2	22.2	22.0	21.8	21.7	21.8	20.5	17.9	15.9	14.2	12.7	20.0
22.0	19.5	19.5	19.3	19.1	19.0	19.1	19.0	16.8	14.9	13.3	11.9	22.0
24.0	17.4	17.3	17.1	16.9	16.8	16.9	16.8	15.8	14.0	12.5	11.1	24.0
26.0	15.6	15.5	15.3	15.1	15.0	15.1	15.0	14.9	13.2	11.8	10.5	26.0
28.0	14.1	14.0	13.8	13.6	13.5	13.6	13.5	13.4	12.5	11.1	9.9	28.0
30.0	12.8	12.7	12.5	12.3	12.2	12.3	12.2	12.1	11.9	10.6	9.5	30.0
32.0	11.7	11.6	11.4	11.2	11.1	11.2	11.0	11.0	10.9	10.1	9.0	32.0
34.0	10.7	10.6	10.4	10.2	10.1	10.2	10.1	10.0	10.0	9.7	8.6	34.0
36.0	9.8	9.8	9.6	9.4	9.2	9.3	9.2	9.2	9.1	9.0	8.3	36.0
38.0	9.1	9.0	8.8	8.6	8.5	8.6	8.4	8.4	8.3	8.2	8.0	38.0
40.0	8.4	8.3	8.1	7.9	7.8	7.9	7.8	7.7	7.7	7.5	7.5	40.0
42.0	7.8	7.7	7.5	7.3	7.2	7.3	7.2	7.1	7.0	6.9	6.9	42.0
44.0	7.3	7.2	7.0	6.8	6.7	6.7	6.6	6.6	6.5	6.4	6.3	44.0
46.0	6.8	6.7	6.5	6.3	6.2	6.2	6.1	6.1	6.0	5.9	5.8	46.0
48.0	46.4m/6.8	6.3	6.1	5.9	5.7	5.8	5.7	5.6	5.5	5.4	5.4	48.0
50.0		49.1m/6.1	5.7	5.5	5.3	5.4	5.2	5.2	5.1	5.0	4.9	50.0
52.0			51.7m/5.4	5.1	5.0	5.0	4.9	4.8	4.7	4.6	4.5	52.0
54.0				4.8	4.6	4.6	4.5	4.4	4.4	4.2	4.1	54.0
56.0				54.4m/4.7	4.3	4.3	4.2	4.1	4.0	3.9	3.8	56.0
58.0					56.9m/4.1	4.0	3.8	3.8	3.7	3.5	3.4	58.0
60.0						59.6m/3.8	3.5	3.5	3.4	3.2	3.1	60.0
62.0							3.3	3.2	3.1	3.0	2.9	62.0
64.0							62.2m/3.2	2.9	2.9	2.7	2.6	64.0
66.0								64.9m/2.8	2.6	2.5	2.4	66.0
68.0									67.5m/2.4	2.2	2.1	68.0
70.0										2.0		70.0
72.0										70.1m/2.0		72.0
Reeves	4	3	3	3	3	2	2	2	2	2	2	Reeves

Note: Ratings according to EN13000.

Ratings shown in are determined by the strength of the boom or other structural components.

Lifting capacities may vary depending on hook used or with/without auxiliary sheave.

Please refer rated chart in operator's cabin.



Luffing Boom Lifting Capacities

Counterweight: 55.0 t
Carbody Weight: 10.8 t

Unit: metric ton

Working radius (m)	Boom length (m)	14.4	17.4	20.5	23.5	26.6	29.6	32.7	35.7	38.8	41.8	44.8	47.9	Boom length (m)	Working radius (m)
5.0	5.4m/80.0														5.0
6.0	80.0	80.0	6.5m/80.0												6.0
7.0	80.0	80.0	80.0	80.0	7.5m/80.0										7.0
8.0	80.0	79.4	78.8	77.0	75.2	8.1m/72.7	8.6m/66.0								8.0
9.0	68.2	68.2	68.1	66.8	65.3	63.8	62.5	9.1m/60.3	9.7m/55.7						9.0
10.0	58.3	58.3	58.2	58.1	57.7	56.4	55.2	54.1	53.4	10.2m/51.3	10.7m/48.0	11.2m/44.5		10.0	
12.0	44.1	44.9	44.8	44.7	44.6	44.4	44.3	43.8	43.1	42.3	41.9	41.2		12.0	
14.0	32.5	36.4	36.2	36.1	36.0	35.8	35.6	35.5	35.4	35.3	35.0	34.2		14.0	
16.0	14.6m/29.1	29.3	30.2	30.1	30.0	29.8	29.6	29.5	29.4	29.2	29.2	29.0		16.0	
18.0		17.3m/24.5	25.8	25.7	25.6	25.3	25.2	25.1	24.9	24.8	24.7	24.5		18.0	
20.0			19.9m/20.7	22.3	22.2	21.9	21.8	21.7	21.5	21.4	21.3	21.1		20.0	
22.0				19.0	19.5	19.3	19.1	19.0	18.8	18.7	18.6	18.4		22.0	
24.0				22.5m/17.8	17.3	17.1	16.9	16.8	16.6	16.5	16.4	16.2		24.0	
26.0					25.2m/15.5	15.3	15.2	15.0	14.8	14.7	14.6	14.4		26.0	
28.0						27.8m/13.4	13.7	13.5	13.3	13.2	13.1	12.9		28.0	
30.0							12.2	12.2	12.0	11.9	11.8	11.6		30.0	
32.0							30.5m/11.7	11.1	10.9	10.8	10.7	10.5		32.0	
34.0								33.1m/10.2	10.0	9.8	9.7	9.5		34.0	
36.0									35.7m/8.8	9.0	8.9	8.6		36.0	
38.0										7.9	8.1	7.9		38.0	
40.0										38.4m/7.7	7.2	7.2		40.0	
42.0											41.0m/6.7	6.4		42.0	
44.0												43.7m/5.6		44.0	
Reeves		6	6	6	6	6	6	5	5	5	4	4	4	Reeves	

Note: Ratings according to EN13000.

Ratings shown in are determined by the strength of the boom or other structural components.

Lifting capacities may vary depending on hook used or with/without auxiliary sheave.

Please refer rated chart in operator's cabin.

SUPPLEMENTAL DATA

- Ratings according to EN13000.
- Operating radius is the horizontal distance from centerline of rotation to a vertical line through the center of gravity of the load.
- Ratings shown are based on freely suspended loads and make no allowance for such factors as wind effect on lifted load, ground conditions, out-of-level, operating speeds or any other condition that could be detrimental to the safe operation of this equipment.
The operator, therefore, has the responsibility to judge the existing conditions and reduce lifted loads and operating speeds accordingly.
- Ratings are for operation on a firm and level surface, up to 1% gradient.
- At radii and boom lengths where no ratings are shown on chart, operation is not intended nor approved.
- Boom and jib inserts and guy lines must be arranged as shown in the "operator's manual".
- Boom hoist reeving is 12 part line.
- Jib hoist reeving is 8 part line.
- Gantry must be in raised position for all conditions.
- Boom and jib backstops are required for all boom and jib combinations.
- Ratings inside of boxes are limited by strength of materials.
- The boom should be erected over the front of the crawlers, not laterally.
- When erecting and lowering for all boom and jib combinations, the blocks for erection must be placed under the front of the crawlers.
- The minimum rated load is 2.0 (ton).
- All ratings shown is calculated in the condition equipped with the auxiliary sheave frame.

(Luffing boom lifting with luffing jib)

- The total load that can be lifted is the value for weight of main hook block, slings, and all other load handling accessories deducted from luffing boom with luffing jib rating shown.

(Luffing jib lifting)

- The total load that can be lifted is the value for weight of jib hook block, slings, and all other load handling accessories deducted from luffing jib rated shown.

1. Availability of luffing boom and jib combinations.

		Jib Length (m)										
		22.9	25.9	29.0	32.0	35.1	38.1	41.1	44.2	47.2	50.3	53.3
Boom Length (m)	32.7	○	○	○	○	○	○	○	○	○	○	○
	35.7	○	○	○	○	○	○	○	○	○	○	○
	38.8	○	○	○	○	○	○	○	○	○	○	○
	41.8	○	○	○	○	○	○	○	○	○	○	○
	44.8	○	○	○	○	○	○	○	○	○	○	○
	47.9	○	○	○	○	×	×	×	×	×	×	×

○: Combinations which is allowed. ×: Combinations which is not allowed.

2. Maximum hoist load for number of reeving parts of line for hoist rope.

For Main Boom Hook

No. of Parts of Line	1	2	3	4
Maximum Loads (kN)	132	263	393	525
Maximum Loads (t)	13.5	27.0	40.5	54.0

For Jib Hook

No. of Parts of Line	1	2	3
Maximum Loads (kN)	132	263	393
Maximum Loads (t)	13.5	27.0	40.5

For Auxiliary Sheave

No. of Parts of Line	1
Maximum Loads (kN)	132
Maximum Loads (t)	13.5

Weight of hook block			
Hook Block	70 t	35 t	Ball Hook
Weight (t)	1.2	0.9	0.45

Operation of this equipment in excess of rated loads or disregard of instruction voids the warranty.

LIFTING CAPACITIES



Luffing Boom Lifting Capacities with Lifting Jib (Attached at 25 degree boom to luffing jib offset angle)

Counterweight: 55.0 t
Carbody Weight: 10.8 t

Unit: metric ton

32.7 m Boom Length	Boom length (m)	32.7											Boom length (m)
	Jib length (m)	22.9	25.9	29.0	32.0	35.1	38.1	41.1	44.2	47.2	50.3	53.3	Jib length (m)
Working radius (m)	8.6	53.9	52.3	50.5	49.0	47.4	45.4	43.7	41.9	39.6	37.7	35.6	8.6
	9.0	50.5	49.0	47.3	45.8	44.3	42.3	40.6	38.9	36.7	34.8	32.8	9.0
	10.0	43.5	42.0	40.4	39.0	37.6	35.8	34.2	32.5	30.5	28.7	26.8	10.0
	12.0	32.7	31.4	29.9	28.7	27.4	25.8	24.3	22.9	21.1	19.5	17.8	12.0
	14.0	24.5	23.2	21.9	20.7	19.5	18.0	16.7	15.4	13.7	12.2	10.7	14.0
	16.0	18.7	17.5	16.3	15.2	14.1	12.7	11.5	10.2	8.6	7.3	5.9	16.0
	18.0	14.4	13.3	12.1	11.1	10.0	8.7	7.6	6.4	4.9			18.0
	20.0	11.2	10.1	9.0	8.0	7.0	5.7						20.0
	22.0	8.7	7.6	6.5	5.6								22.0
	24.0	6.7	5.7										24.0
26.0	5.0											26.0	
Reeves		4	4	4	4	4	4	4	4	3	3	3	Reeves

35.7 m Boom Length	Boom length (m)	35.7											Boom length (m)
	Jib length (m)	22.9	25.9	29.0	32.0	35.1	38.1	41.1	44.2	47.2	50.3	53.3	Jib length (m)
Working radius (m)	9.1	48.5	46.9	45.3	43.8	42.3	40.5	38.8	37.1	35.0	33.1	31.1	9.1
	10.0	42.5	41.0	39.4	38.1	36.7	34.9	33.3	31.7	29.7	28.0	26.1	10.0
	12.0	32.5	31.2	29.8	28.6	27.3	25.7	24.3	22.9	21.1	19.5	17.9	12.0
	14.0	24.5	23.2	21.9	20.8	19.6	18.2	16.9	15.6	13.9	12.5	11.0	14.0
	16.0	18.7	17.6	16.3	15.3	14.2	12.8	11.6	10.4	8.9	7.5	6.1	16.0
	18.0	14.4	13.3	12.1	11.2	10.1	8.8	7.7	6.5	5.1			18.0
	20.0	11.2	10.1	9.0	8.1	7.1	5.9						20.0
	22.0	8.6	7.6	6.5	5.6								22.0
	24.0	6.7	5.7										24.0
	26.0	5.0											26.0
Reeves		4	4	4	4	4	4	3	3	3	3	3	Reeves

38.8 m Boom Length	Boom length (m)	38.8											Boom length (m)
	Jib length (m)	22.9	25.9	29.0	32.0	35.1	38.1	41.1	44.2	47.2	50.3	53.3	Jib length (m)
Working radius (m)	9.7	43.7	42.2	40.6	39.2	37.8	36.0	34.5	32.8	30.9	29.1	27.2	9.7
	10.0	41.4	40.0	38.5	37.1	35.7	34.0	32.4	30.8	28.9	27.2	25.4	10.0
	12.0	31.6	30.3	28.9	27.7	26.5	24.9	23.5	22.1	20.4	18.8	17.2	12.0
	14.0	24.3	23.1	21.8	20.7	19.6	18.1	16.9	15.6	14.0	12.6	11.1	14.0
	16.0	18.5	17.3	16.1	15.1	14.0	12.7	11.5	10.3	8.8	7.5	6.2	16.0
	18.0	14.3	13.2	12.1	11.1	10.1	8.8	7.7	6.6	5.1			18.0
	20.0	11.1	10.0	8.9	8.0	7.0	5.8						20.0
	22.0	8.5	7.5	6.4	5.6								22.0
	24.0	6.4	5.5										24.0
	Reeves		4	4	4	3	3	3	3	3	3	3	3

Note: Ratings according to EN13000.

Ratings shown in are determined by the strength of the boom or other structural components.

Lifting capacities may vary depending on hook used or with/without auxiliary sheave.

Please refer rated chart in operator's cabin.

LIFTING CAPACITIES



Luffing Boom Lifting Capacities with Lifting Jib (Attached at 25 degree boom to luffing jib offset angle)

Counterweight: 55.0 t
Carbody Weight: 10.8 t

Unit: metric ton

41.8 m Boom Length	Boom length (m)	41.8											Boom length (m)
	Jib length (m)	22.9	25.9	29.0	32.0	35.1	38.1	41.1	44.2	47.2	50.3	53.3	Jib length (m)
Working radius (m)	10.2	39.6	38.1	36.6	35.3	34.0	32.3	30.8	29.2	27.3	25.6	23.9	10.2
	12.0	31.0	29.7	28.3	27.1	25.9	24.4	23.0	21.6	19.9	18.4	16.8	12.0
	14.0	24.3	23.1	21.8	20.8	19.6	18.2	17.0	15.7	14.1	12.7	11.3	14.0
	16.0	18.5	17.3	16.1	15.1	14.1	12.7	11.6	10.4	8.9	7.7	6.3	16.0
	18.0	14.3	13.2	12.1	11.1	10.1	8.9	7.8	6.7	5.3			18.0
	20.0	11.0	10.0	8.9	8.0	7.1	5.9	4.8					20.0
	22.0	8.5	7.5	6.4	5.6								22.0
	24.0	6.4	5.4										24.0
	Reeves	3	3	3	3	3	3	3	3	3	2	2	Reeves

44.8 m Boom Length	Boom length (m)	44.8											Boom length (m)
	Jib length (m)	22.9	25.9	29.0	32.0	35.1	38.1	41.1	44.2	47.2	50.3	53.3	Jib length (m)
Working radius (m)	10.7	36.4	35.1	33.6	32.4	31.1	29.4	28.0	26.5	24.7	23.1	21.4	10.7
	12.0	30.6	29.4	28.0	26.8	25.6	24.1	22.8	21.4	19.7	18.2	16.6	12.0
	14.0	24.1	22.9	21.6	20.6	19.5	18.0	16.8	15.6	14.0	12.7	11.2	14.0
	16.0	18.5	17.4	16.2	15.2	14.2	12.9	11.8	10.6	9.1	7.9	6.6	16.0
	18.0	14.2	13.2	12.0	11.1	10.1	8.9	7.8	6.7	5.4			18.0
	20.0	11.0	10.0	8.9	8.0	7.1	5.9	4.9					20.0
	22.0	8.4	7.4	6.4	5.5								22.0
	24.0	6.3	5.4										24.0
	Reeves	3	3	3	3	3	3	3	2	2	2	2	Reeves

47.9 m Boom Length	Boom length (m)	47.9											Boom length (m)
	Jib length (m)	22.9	25.9	29.0	32.0								Jib length (m)
Working radius (m)	11.2	33.2	31.9	30.5	29.3								11.2
	12.0	30.1	28.8	27.5	26.3								12.0
	14.0	23.5	22.3	21.1	20.0								14.0
	16.0	18.4	17.3	16.2	15.2								16.0
	18.0	14.1	13.1	12.0	11.1								18.0
	20.0	10.9	9.9	8.8	8.0								20.0
	22.0	8.3	7.4	6.4	5.5								22.0
	24.0	6.2	5.3										24.0
	Reeves	3	3	3	3								Reeves

Note: Ratings according to EN13000.

Ratings shown in are determined by the strength of the boom or other structural components.

Lifting capacities may vary depending on hook used or with/without auxiliary sheave.

Please refer rated chart in operator's cabin.

LIFTING CAPACITIES



Luffing Jib Lifting Capacities

Counterweight: 55.0 t
Carbody Weight: 10.8 t

Unit: metric ton

47.9 m Boom Length	Boom length (m)		22.9												25.9						47.9						29.0						32.0						Boom length (m)	
	Jib length (m)		22.9												25.9						47.9						29.0						32.0						Jib length (m)	
	Boom angle (deg)		88	83	78	73	68	63	88	83	78	73	68	63	88	83	78	73	68	63	88	83	78	73	68	63	88	83	78	73	68	63	Boom angle (deg)							
Working radius (m)	12.0	27.8																															12.0							
	14.0	26.4																															14.0							
	16.0	25.0																															16.0							
	18.0	23.8	25.2																															18.0						
	20.0	21.1	22.1																															20.0						
	22.0	17.7	19.6																															22.0						
	24.0	15.0	17.5	15.5																														24.0						
	26.0	15.8	14.1																																26.0					
	28.0		14.4	12.8																															28.0					
	30.0		13.1	11.7	10.2																														30.0					
	32.0			10.8	9.6																														32.0					
	34.0			9.9	8.8																														34.0					
	36.0				8.2	6.7																													36.0					
	38.0					7.6	6.5																												38.0					
	40.0						6.0																												40.0					
	42.0							5.5	4.2																										42.0					
	44.0								4.1																										44.0					
	46.0									3.8																									46.0					
	48.0																																			48.0				
	50.0																																			50.0				
52.0																																			52.0					
54.0																																			54.0					
	Reeves																																	Reeves						

Note: Ratings according to EN13000.

Ratings shown in are determined by the strength of the boom or other structural components.

Lifting capacities may vary depending on hook used or with/without auxiliary sheave.

Please refer rated chart in operator's cabin.

SUPPLEMENTAL DATA FOR CLAMSHELL RATING CHART

- Operating radius is the horizontal distance from centerline of rotation to a vertical line through the center of gravity of the load.
- Deduct weight of bucket, slings and all other load handling accessories from main boom ratings shown.
- Ratings shown are based on freely suspended loads and make no allowance for such factors as wind effect on lifted load, ground conditions, out-of-level, operating speeds or any other condition that could be detrimental to the safe operation of this equipment. The operator, therefore, has the responsibility to judge the existing conditions and reduce lifted loads and operating speeds accordingly.
- Rated loads do not exceed 66% of minimum tipping loads.
- Ratings are for operation on a firm and level surface, up to 1% gradient.
- At radii and boom lengths where no ratings are shown on chart, operation is not intended nor approved.
- Boom inserts and guy lines must be arranged as shown in the "operator's manual".
- Boom hoist reeving is 12 part line.
- Gantry must be in raised position for all conditions.
- Boom backstops are required for all boom lengths.
- The boom should be erected over the front of the crawlers, not laterally.

(Clamshell bucket lifting)

- The total load that can be lifted is the value for weight of bucket, slings, and all other load handling accessories deducted from main boom ratings shown.
- The weight of bucket and materials must not exceed rated load.
- Optimum bucket should be required according to material. $\text{Bucket capacity (m}^3\text{) } \times \text{ specified gravity of material (ton/m}^3\text{) } + \text{ bucket weight (ton) } = \text{rated load.}$
- Bucket weight must also be decreased according to operating cycle and bucket lowering height.
- Rated loads are determined by stability and boom strength. during simultaneous operations of boom and swing, rapid acceleration or deceleration must be avoided.
- Do not attempt to cast the bucket while swinging or diagonal draw-cutting.

<Reference Information>

Main hoist loads

No. of Parts of Line	1
Maximum Loads (kN)	113
Maximum Loads (t)	11.5

Assembling the counterweight

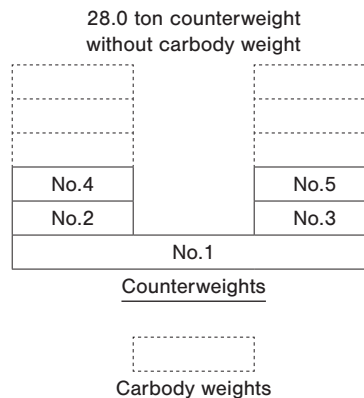

Operation of this equipment in excess of rated loads or disregard of instruction voids the warranty.

LIFTING CAPACITIES



Clamshell Rating Charts Crane Boom Capacities

Counterweight: 28.0 t
Without Carbody Weight

Unit: metric ton

Load radius (m) \ Boom length (m)	15.2	18.3	21.3	24.4	27.4				Boom length (m) \ Load radius (m)
7.0	11.5								7.0
8.0	11.5	11.5							8.0
9.0	11.5	11.5							9.0
10.0	11.5	11.5	11.5						10.0
12.0	11.5	11.5	11.5	11.5	10.0				12.0
14.0	11.5	11.5	11.5	11.5	10.0				14.0
16.0		11.5	11.5	11.5	10.0				16.0
18.0			11.5	11.5	10.0				18.0
20.0				11.5	10.0				20.0
22.0					10.0				22.0
24.0									24.0
26.0									26.0
28.0									28.0
30.0									30.0
32.0									32.0
34.0									34.0
36.0									36.0
38.0									38.0
40.0									40.0
42.0									42.0
44.0									44.0
46.0									46.0
48.0									48.0
50.0									50.0
52.0									52.0
54.0									54.0
56.0									56.0
58.0									58.0
60.0									60.0
62.0									62.0
64.0									64.0
Reeves	1	1	1	1	1				Reeves

Note:
Please refer rated chart in operator's cabin.

SUPPLEMENTAL DATA FOR REDUCED WEIGHTS RATING CHART

- Ratings according to EN13000.
- Operating radius is the horizontal distance from centerline of rotation to a vertical line through the center of gravity of the load.
- Deduct weight of hook block (s), slings and all other load handling accessories from main boom ratings shown.
- Ratings shown are based on freely suspended loads and make no allowance for such factors as wind effect on lifted load, ground conditions, out-of-level, operating speeds or any other condition that could be detrimental to the safe operation of this equipment. The operator, therefore, has the responsibility to judge the existing conditions and reduce lifted loads and operating speeds accordingly.
- Ratings are for operation on a firm and level surface, up to 1% gradient.
- At radii and boom lengths where no ratings are shown on chart, operation is not intended nor approved.
- Boom inserts and guy lines must be arranged as shown in the "operator's manual".
- Boom hoist reeving is 12 parts line.
- Gantry must be in raised position for all conditions.
- Boom backstops are required for all boom lengths.
- The boom should be erected over the front of the crawlers, not laterally.
- When erecting and lowering the boom length of 73.2 m (240 ft) or over, the blocks for erection must be placed at the end of the crawlers.
- Ratings inside of boxes are limited by strength of materials.
- The minimum rated load is 2.0 (ton).

(Crane boom lifting)

- The total load that can be lifted is the value for weight of hook block, slings, and all other load handling accessories deducted from main boom ratings shown.

Counterweight	Carbody weight	Boom length	
		Without aux.	With aux.
46.0 ton	Without	15.2 m to 76.2 m	15.2 m to 73.2 m

Assembling the counterweight

46.0 ton counterweight
without carbody weight

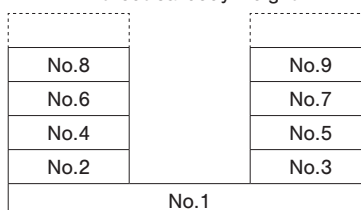

Counterweights

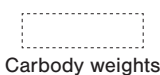

Carbody weights

<Reference Information>

Main hoist loads

No. of Parts of Line	1	2	3	4	5
Maximum Loads (kN)	132	265	397	530	662
Maximum Loads (t)	13.5	27.0	40.5	54.0	67.5

No. of Parts of Line	6	7	8	9	10
Maximum Loads (kN)	794	927	1,059	1,192	1,324
Maximum Loads (t)	81.0	94.5	108.0	121.5	135.0

Auxiliary hoist loads

No. of Parts of Line	1	2
Maximum Loads (kN)	132	265
Maximum Loads (t)	13.5	27.0

Weight of hook block				
Hook Block	135 t	70 t	35 t	Ball Hook
Weight (t)	1.7	1.2	0.9	0.45

Operation of this equipment in excess of rated loads or disregard of instruction voids the warranty.

LIFTING CAPACITIES



Reduced Weights Rating Charts Crane Boom Lifting Capacities

Counterweight: 46.0 t
Without Carbody Weight

Unit: metric ton

Load radius (m)	Boom length (m)														Boom length (m)	Load radius (m)	
		15.2	18.3	21.3	24.4	27.4	30.5	33.5	36.6	39.6	42.7	45.7	48.8	51.8			
4.5	4.5m/127.2																4.5
5.0	123.5	5.1m/122.1															5.0
5.5	117.9	117.7	5.6m/115.2														5.5
6.0	108.6	108.4	105.2	6.1m/96.2	6.7m/83.8												6.0
7.0	84.6	84.5	84.5	82.8	79.5	7.2m/74.1	7.7m/65.3										7.0
8.0	68.0	67.8	67.8	67.7	67.6	65.6	63.5	8.2m/58.9	8.8m/53.6								8.0
9.0	56.7	56.5	56.5	56.3	56.2	56.2	55.6	53.9	52.3	9.3m/48.5	9.8m/44.6						9.0
10.0	48.5	48.4	48.3	48.2	48.0	48.0	47.9	47.7	46.6	45.4	44.1	10.4m/41.2	10.9m/38.2				10.0
12.0	37.5	37.3	37.2	37.1	37.0	36.9	36.8	36.6	36.6	36.5	36.2	35.3	34.5				12.0
14.0	30.5	30.3	30.1	30.0	29.8	29.8	29.7	29.5	29.5	29.3	29.2	29.0	29.0				14.0
16.0	14.8m/28.3	25.3	25.2	25.1	24.9	24.8	24.7	24.5	24.5	24.4	24.2	24.0	24.0				16.0
18.0		17.5m/22.5	21.6	21.4	21.2	21.2	21.1	20.9	20.8	20.7	20.5	20.3	20.3				18.0
20.0			18.8	18.6	18.4	18.4	18.3	18.1	18.0	17.9	17.7	17.5	17.5				20.0
22.0			20.1m/18.8	16.5	16.2	16.2	16.1	15.8	15.8	15.6	15.4	15.3	15.2				22.0
24.0				22.8m/15.7	14.5	14.4	14.3	14.0	14.0	13.8	13.6	13.5	13.4				24.0
26.0					25.4m/13.4	12.9	12.8	12.6	12.5	12.3	12.1	12.0	11.9				26.0
28.0						11.7	11.5	11.3	11.2	11.1	10.9	10.7	10.7				28.0
30.0							28.1m/11.6	10.5	10.3	10.2	10.0	9.8	9.6	9.6			30.0
32.0								30.7m/10.1	9.4	9.2	9.1	8.9	8.7	8.7			32.0
34.0									33.3m/8.8	8.5	8.3	8.1	7.9	7.9			34.0
36.0										7.7	7.6	7.4	7.2	7.2			36.0
38.0											7.0	6.8	6.6	6.5			38.0
40.0											38.6m/6.8	6.2	6.1	6.0			40.0
42.0												41.2m/5.9	5.5	5.4			42.0
44.0													43.9m/5.0	4.9			44.0
46.0														4.5			46.0
48.0															46.5m/4.4		48.0
50.0																	50.0
52.0																	52.0
54.0																	54.0
56.0																	56.0
Reeves	10	10	9	8	7	6	5	5	4	4	4	4	3				Reeves

Load radius (m)	Boom length (m)											Boom length (m)	Load radius (m)				
		54.9	57.9	61.0	64.0	67.1	70.1	73.2	76.2								
10.0	11.4m/35.1	11.9m/32.7															10.0
12.0	33.5	32.7	12.5m/30.5	13.0m/28.3	13.5m/25.8												12.0
14.0	28.3	27.7	27.0	26.3	25.2	14.1m/22.7	14.6m/20.0	15.1m/17.6									14.0
16.0	23.8	23.7	23.2	22.6	22.1	20.6	18.6	16.8									16.0
18.0	20.1	20.0	19.8	19.7	19.2	18.7	16.9	15.2									18.0
20.0	17.3	17.2	17.0	16.8	16.8	16.4	15.4	13.8									20.0
22.0	15.0	14.9	14.7	14.6	14.5	14.4	14.1	12.7									22.0
24.0	13.2	13.1	12.9	12.8	12.7	12.6	12.4	11.7									24.0
26.0	11.7	11.6	11.4	11.2	11.2	11.1	10.9	10.7									26.0
28.0	10.5	10.3	10.2	10.0	9.9	9.8	9.6	9.5									28.0
30.0	9.4	9.2	9.1	8.9	8.9	8.7	8.5	8.4									30.0
32.0	8.5	8.3	8.1	8.0	7.9	7.8	7.6	7.4									32.0
34.0	7.7	7.5	7.3	7.2	7.1	7.0	6.8	6.6									34.0
36.0	6.9	6.8	6.6	6.4	6.4	6.2	6.0	5.8									36.0
38.0	6.3	6.2	6.0	5.8	5.7	5.5	5.3	5.1									38.0
40.0	5.7	5.5	5.3	5.1	5.1	4.9	4.7	4.5									40.0
42.0	5.2	5.0	4.8	4.6	4.5	4.3	4.1	3.9									42.0
44.0	4.7	4.5	4.3	4.1	4.0	3.8	3.6	3.4									44.0
46.0	4.2	4.0	3.8	3.6	3.5	3.3	3.1	2.9									46.0
48.0	3.8	3.6	3.4	3.2	3.1	2.9	2.7	2.5									48.0
50.0	49.2m/3.5	3.2	3.0	2.8	2.7	2.5	2.3	2.1									50.0
52.0		51.8m/2.9	2.7	2.5	2.4	2.2	2.0										52.0
54.0			2.3	2.2	2.1												54.0
56.0			54.4m/2.3														56.0
58.0																	58.0
60.0																	60.0
62.0																	62.0
64.0																	64.0
66.0																	66.0
68.0																	68.0
70.0																	70.0
Reeves	3	3	3	3	2	2	2	2									Reeves

Note:

Ratings according to EN13000.

Ratings shown in are determined by the strength of the boom or other structural components.

Lifting capacities may vary depending on hook used or with/without auxiliary sheave.

Please refer rated chart in operator's cabin.

SUPPLEMENTAL DATA FOR BARGE RATING CHART

- Operating radius is the horizontal distance from centerline of rotation to a vertical line through the center of gravity of the load.
- Deduct weight of hook block (s), slings and all other load handling accessories from main boom ratings shown.
- Condition of barge stability this rating chart were determined under the condition below. The stability of barge shall meet below condition. During operation the machinery static inclination against horizontal level.
 - (A) Both sides (right & left) of machine
 - Maximum inclination shall be within 1.5 degrees
 - (B) Front & backward of machine
 - Maximum inclination shall be within 3.0 degrees

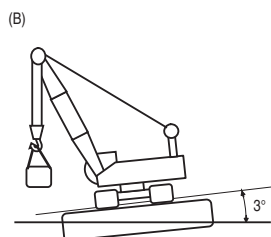
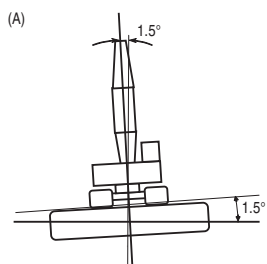
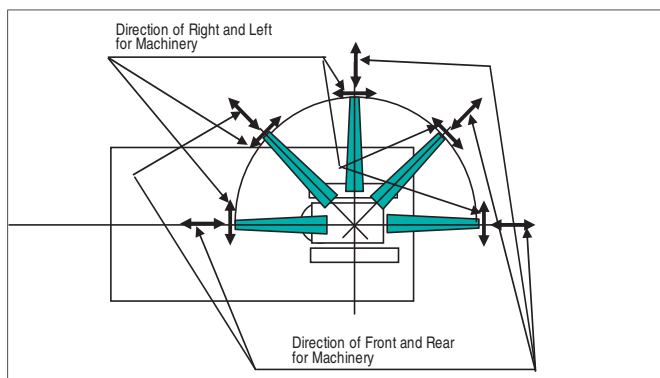

- Working area shall be inshore and smooth water.
- Applicable regulations for structure Japanese construction codes for mobile crane
 - * Regulation of class of shipping (abs, Lloyd, BV, NK, etc) are not adapted.
- At radii and boom lengths where no ratings are shown on chart, operation is not intended nor approved.
- Boom inserts and guy lines must be arranged as shown in the "operator's manual".
- Boom hoist reeving is 12 part line.
- Gantry must be in raised position for all conditions.
- Boom backstops are required for all boom lengths.
- The boom should be erected over the front of the crawlers, not laterally.
- Ratings inside of boxes are limited by strength of materials.
- The minimum rated load is 2.0 (ton).
- The machinery should be fastened to the deck of the barge to prevent tip over and sliding.
- Towing area
 - Towing area shall be within coastal area and quiet wave condition. Offshore and open sea is not considered for this machinery. Depend on the height of wave, counterweight shall be reduced during towing.

(Crane boom lifting)

- The total load that can be lifted is the value for weight of hook block, slings, and all other load handling accessories deducted from main boom ratings shown.

SUPPLEMENTAL DATA FOR BARGE RATING CHART

<Reference Information>

Main hoist loads

No. of Parts of Line	1	2	3	4	5
Maximum Loads (kN)	132	265	397	530	662
Maximum Loads (t)	13.5	27.0	40.5	54.0	67.5

No. of Parts of Line	6
Maximum Loads (kN)	785
Maximum Loads (t)	80.0

Auxiliary hoist loads

No. of Parts of Line	1	2
Maximum Loads (kN)	132	216
Maximum Loads (t)	13.5	22.0

Weight of Hook Block				
Hook Block	135 t	70 t	35 t	13.5 t Ball Hook
Weight (t)	1.7	1.2	0.9	0.45

Operation of this equipment in excess of rated loads or disregard of instruction voids the warranty.

- counterweight shall be reduced, and carbody weight shall be removed according to the boom length as below.

	On Barge		On Ground (Full c/w)
	15.2 m	18.3 m to 39.6 m	15.2 m to 76.2 m
Counterweight	46.0 t	46.0 t	55.0 t
Carbody Weight	10.8 t	None (Removed)	10.8 t

Assembling the counterweight

(Boom Length: 15.2 m)

46.0 ton counterweight

10.8 ton carbody weight

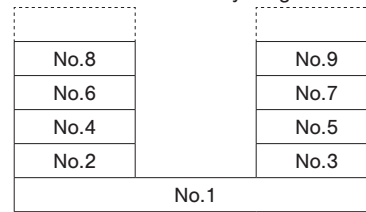

Counterweights

Carbody weights

Assembling the counterweight

(Boom Length: 18.3 m to 39.6 m)

46.0 ton counterweight

without carbody weight

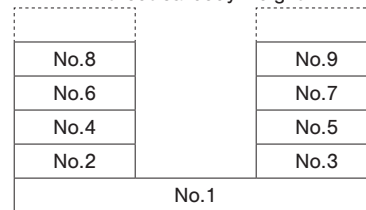

Counterweights

Carbody weights

LIFTING CAPACITIES



Barge Rating Chart Crane Boom Lifting Capacities

	On Barge	
Boom Length	15.2 m	18.3 m to 39.6 m
Counterweight	46.0 t	46.0 t
Carbody Weight	10.8 t	None (Removed)

Unit: metric ton

Load radius (m) \ Boom length (m)	15.2	18.3	21.3	24.4	27.4	30.5	33.5	36.6	39.6	Boom length (m) \ Load radius (m)
5.0	5.3m/80.0									5.0
6.0	69.1	66.8	6.7m/63.0							6.0
7.0	60.7	60.4	60.1	7.4m/56.6						7.0
8.0	52.7	52.4	52.1	51.9	8.1m/51.2	8.7m/46.7				8.0
9.0	46.7	46.6	46.5	46.4	45.5	45.4	9.4m/41.6			9.0
10.0	41.6	41.3	41.0	40.9	40.6	40.4	40.3	10.1m/37.5	10.8m/33.5	10.0
12.0	34.2	33.9	33.6	33.4	33.2	33.0	32.9	32.6	32.2	12.0
14.0	26.4	28.4	28.3	28.2	27.9	27.7	27.5	27.3	27.1	14.0
16.0	14.8m/22.5	23.8	24.2	24.1	23.9	23.8	23.6	23.3	23.1	16.0
18.0		17.5m/18.7	20.4	20.5	20.4	20.3	20.2	20.1	20.0	18.0
20.0			16.0	17.4	17.3	17.2	17.1	17.0	16.9	20.0
22.0			20.1m/15.6	14.7	14.9	14.8	14.7	14.6	14.5	22.0
24.0				22.8m/13.2	12.8	12.8	12.7	12.6	12.5	24.0
26.0					25.4m/11.1	11.2	11.1	11.0	10.9	26.0
28.0						10.0	9.9	9.8	9.7	28.0
30.0							8.9	8.8	8.7	30.0
32.0							30.7m/8.4	8.2	8.1	32.0
34.0								33.3m/7.4	7.6	34.0
36.0									6.6	36.0
Reeves	6	5	5	5	4	4	4	3	3	Reeves

Note:

Ratings according to Japanese construction codes for mobile cranes and Japanese safety ordinance on cranes, etc.

Ratings shown in are determined by the strength of the boom or other structural components.

Lifting capacities may vary depending on hook used or with/without auxiliary sheave.

Please refer rated chart in operator's cabin.

TRANSPORTATION PLAN

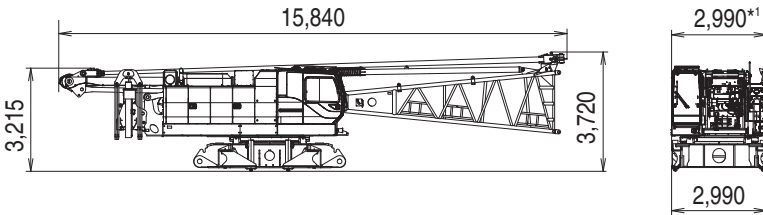
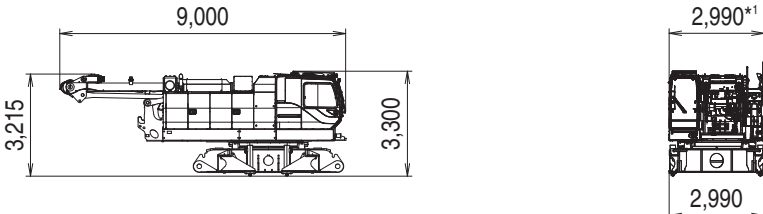
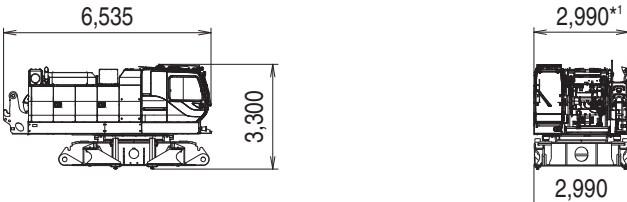
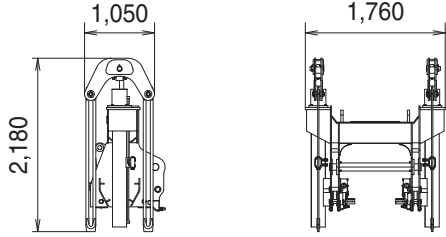
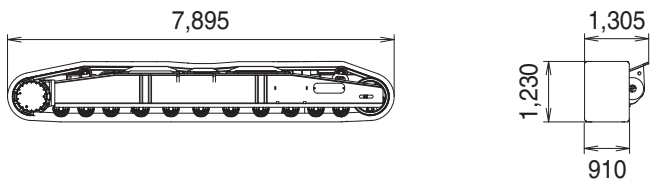
Name	Dimension	Weight (kg)
Base Machine <ul style="list-style-type: none"> • Gantry • Wire rope (Front / rear / boom hoist) • Boom base • Crane backstop • Self removal cylinder • Without crawler • Without side steps 		38,250
Base Machine <ul style="list-style-type: none"> • Gantry • Wire rope (Front / rear / boom hoist) • Without crawler • Without self removal cylinder • Without side steps 		32,430
Base Machine <ul style="list-style-type: none"> • Without crawler • Without gantry • Without wire rope (Boom hoist) • Without self removal cylinder • Without side steps 		29,620
Self removal cylinder		1,510
Crawler		14,225

*1 With the side step on cabin side : 3,170
With the side steps on the both sides : 3,340

PARTS AND ATTACHMENTS

Base Machine

Gantry, Wire rope (Front/rear/boom hoist), Boom base, Crane backstop, Self removal cylinder, Without crawler
Weight: 38,250 kg Width: 2,990 mm

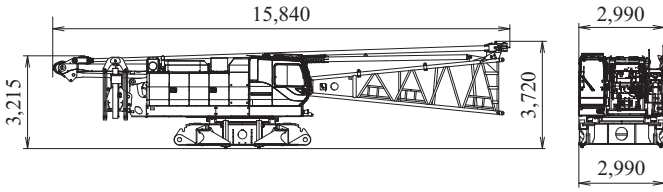

Crawler

Weight: 14,225 kg

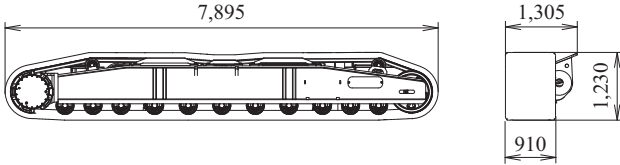

Gantry

Weight: 2,090 kg

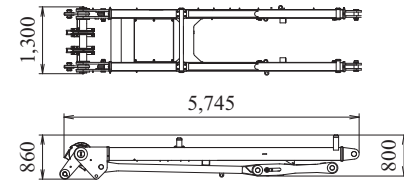

Translifter

Weight: 1,220 kg / 4 Pieces

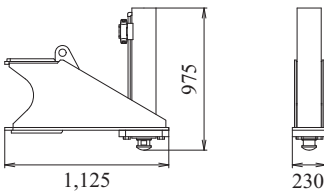

Boom Tip (for Crane)

Weight: 1,670 kg

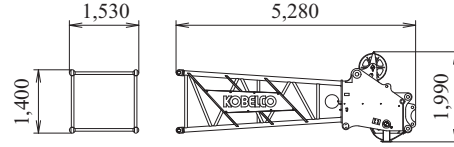

Taper Boom Insert

Weight: 490 kg

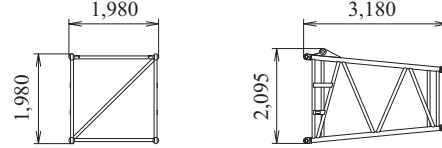

Boom Base

Weight: 4,350 kg

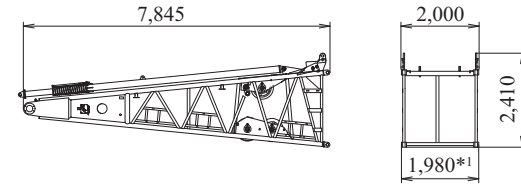

3.0 m Boom Insert

Weight: 530 kg

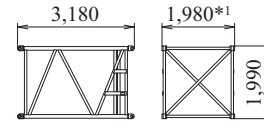

6.1 m Boom Insert

Weight: 850 kg

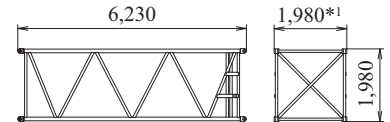

9.1 m Boom Insert

Weight: 1,160 kg

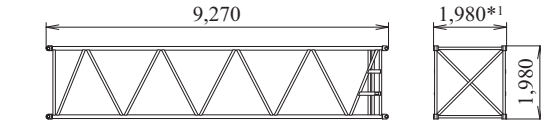

Jib Tip (Fixed Jib)

Weight: 315 kg

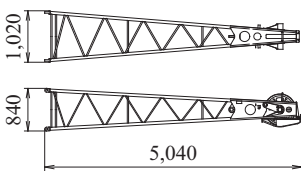

Jib Base (Fixed Jib)

Weight: 210 kg

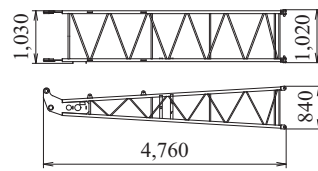

3.0 m Jib Insert (Fixed Jib)

Weight: 110 kg

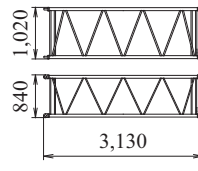

6.1 m Jib Insert (Fixed Jib)

Weight: 190 kg

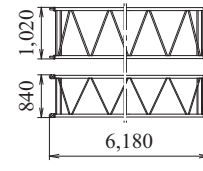

Crane Jib Strut

Weight: 300 kg

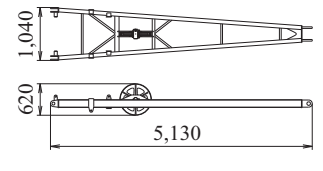

Counterweight (Base Weight)

Weight: 10,000 kg

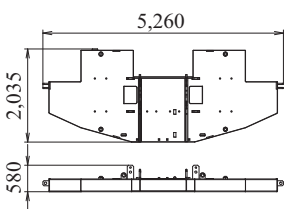

Counterweight

Weight: 4,500 kg

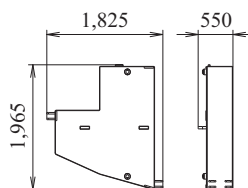

Counterweight

Weight: 4,500 kg

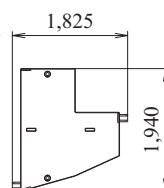

Carbody Weight

Weight: 5,400 kg / 1 Piece

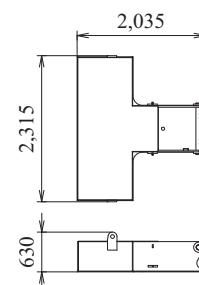

Crane and Luffing Backstop

Weight: 520 kg / 1 Piece

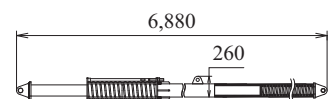

*1 Without pins

Luffing Upper Boom
Weight: 2,465 kg

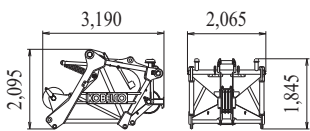

9.1 m Special Boom Insert for Tower (Inc. guide sheave and steps)
Weight: 1,795 kg

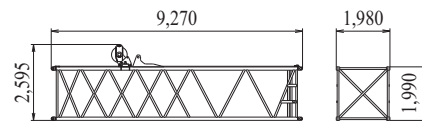

Jib Base (Luffing Jib)
Weight: 1,200 kg

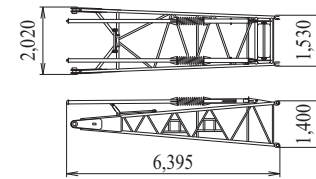

4.3 m Taper Jib Insert (Luffing Jib)
Weight: 410 kg

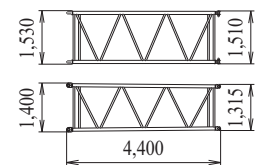

3.0 m Jib Insert (Luffing Jib)
Weight: 310 kg

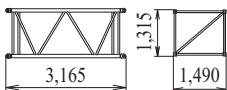

6.1 m Jib Insert (Luffing Jib)
Weight: 540 kg

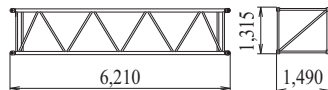

9.1 m Jib Insert (Luffing Jib)
Weight: 740 kg

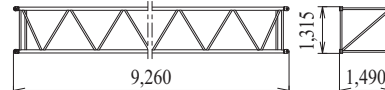

Jib Tip (Luffing Jib)
Weight: 1,170 kg

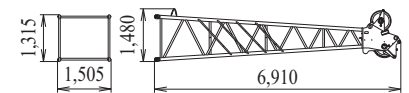

Jib Strut (Luffing Jib)
Weight: 2,010 kg

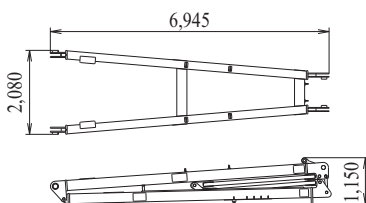

Auxiliary Sheave (for Crane)
Weight: 300 kg

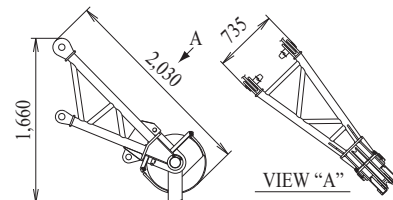

Auxiliary Sheave (for Luffing)
Weight: 380 kg

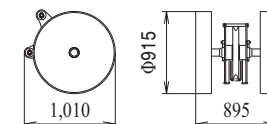

Rear Guide Roller
Weight: 425 kg

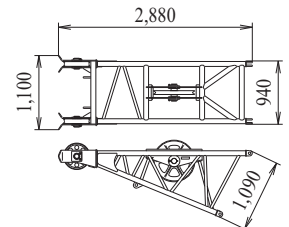

Upper Spreader (for Crane)
Weight: 485 kg

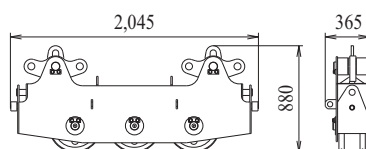

Lower Spreader (for Crane)
Weight: 300 kg

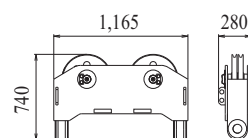

Jib Upper Spreader (for Luffing)
Weight: 260 kg

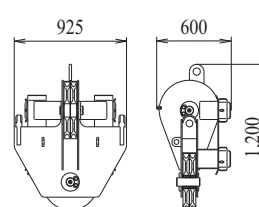

Jib Lower Spreader (for Luffing)
Weight: 405 kg

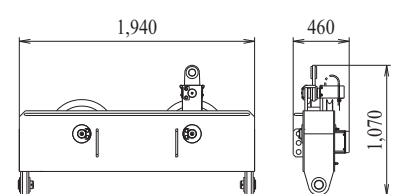

135 t Hook
Weight: 1,700 kg

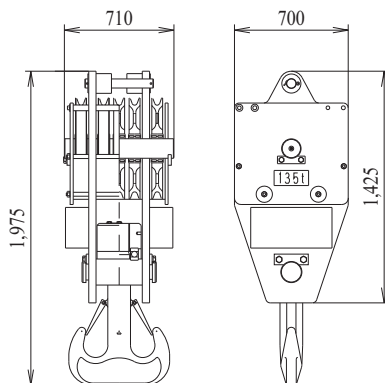

Ball Hook
Weight: 450 kg

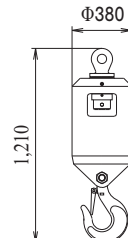

35 t Hook
Weight: 900 kg

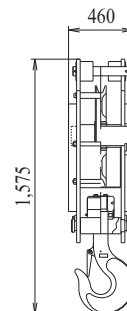

70 t Hook
Weight: 1,200 kg

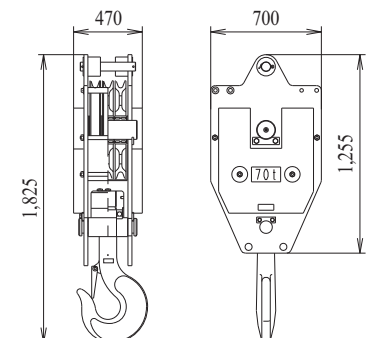

Note: This catalog may contain photographs of machines with specifications, attachments and optional equipment not certified for operation in your country. Please consult KOBELCO for those items you may require. Due to our policy of continual product improvements all designs and specifications are subject to change without advance notice.

Copyright by KOBELCO CONSTRUCTION MACHINERY CO., LTD. No part of this catalog may be reproduced in any manner without notice.

KOBELCO CONSTRUCTION MACHINERY CO., LTD.

Inquiries To:

5-15, Kitashinagawa 5-chome, Shinagawa-ku, Tokyo 141-8626 JAPAN

Tel: +81-3-5789-2121 Fax: +81-3-5789-3372

URL: <https://www.kobelcocm-global.com>