

アタッチメント取付台

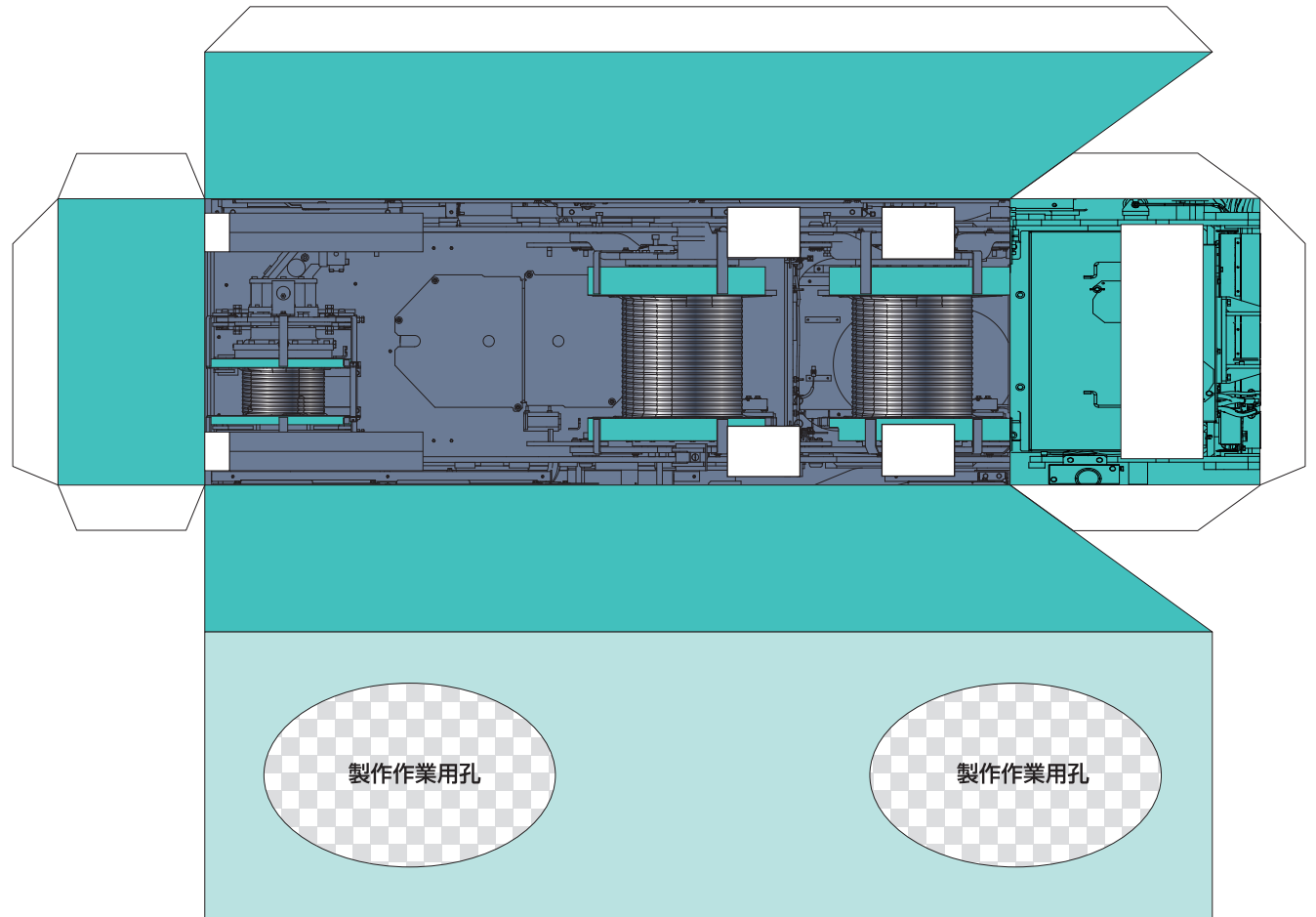

下部ブーム

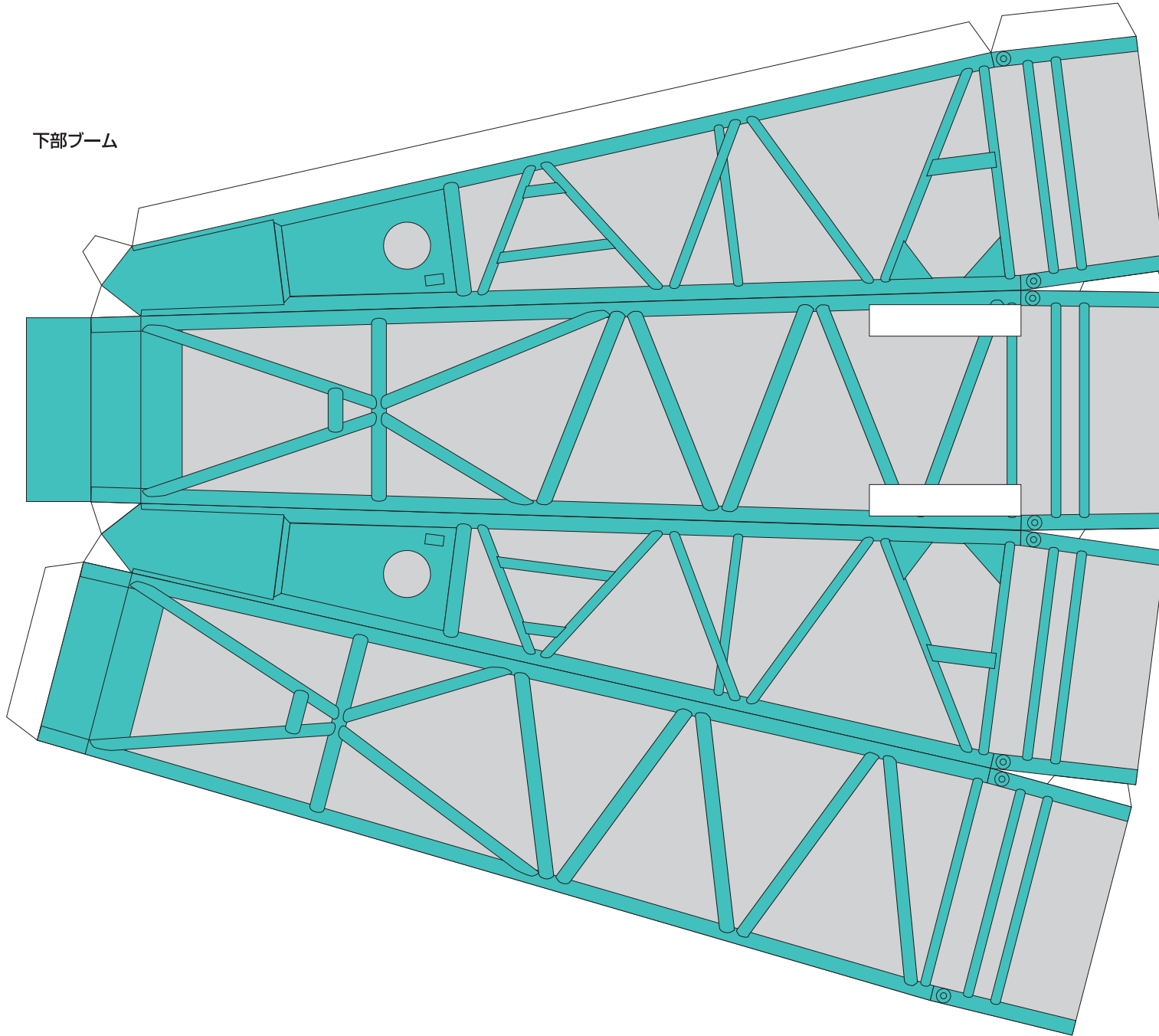

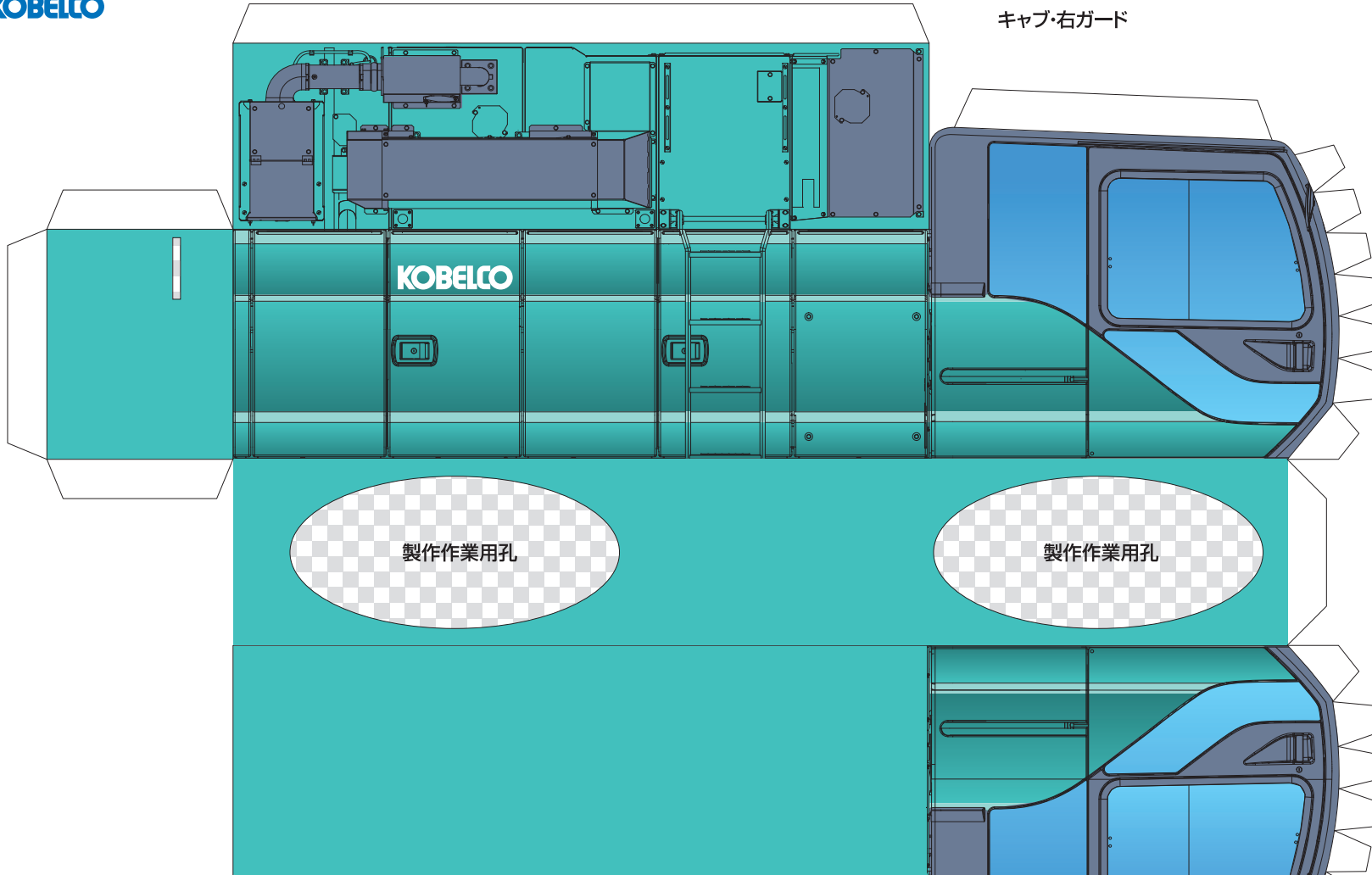

キャブ・右ガード

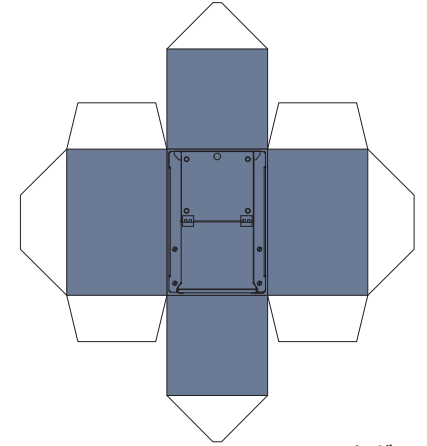

マフラーなど

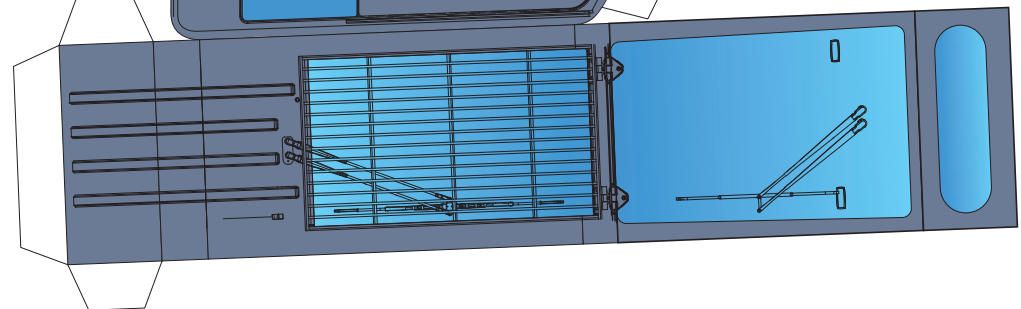
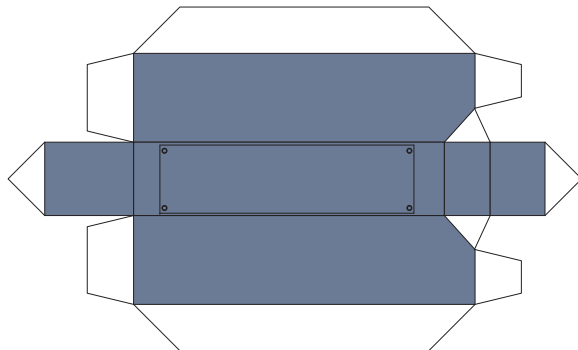
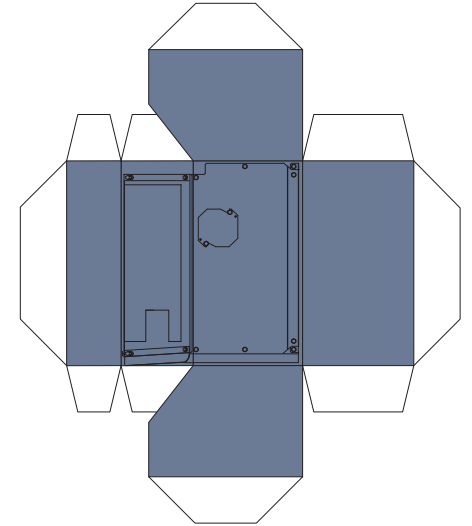

カーボディ・カーボディウエイト

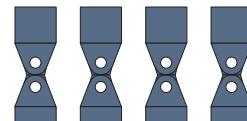
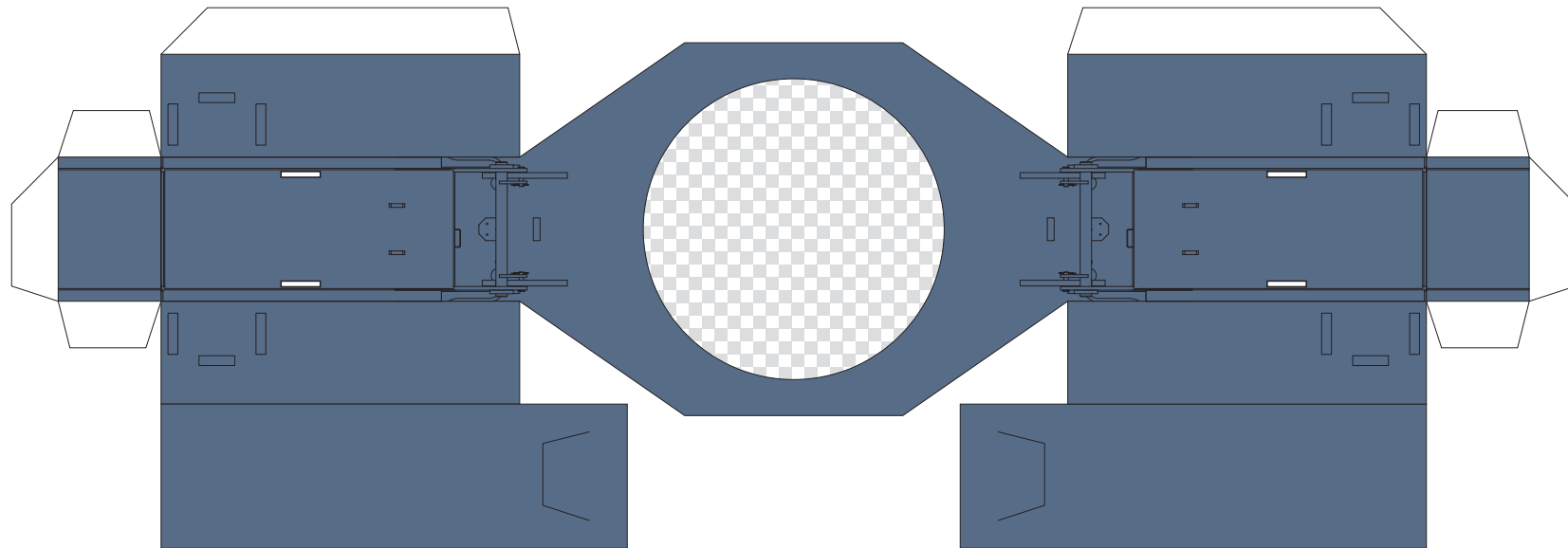
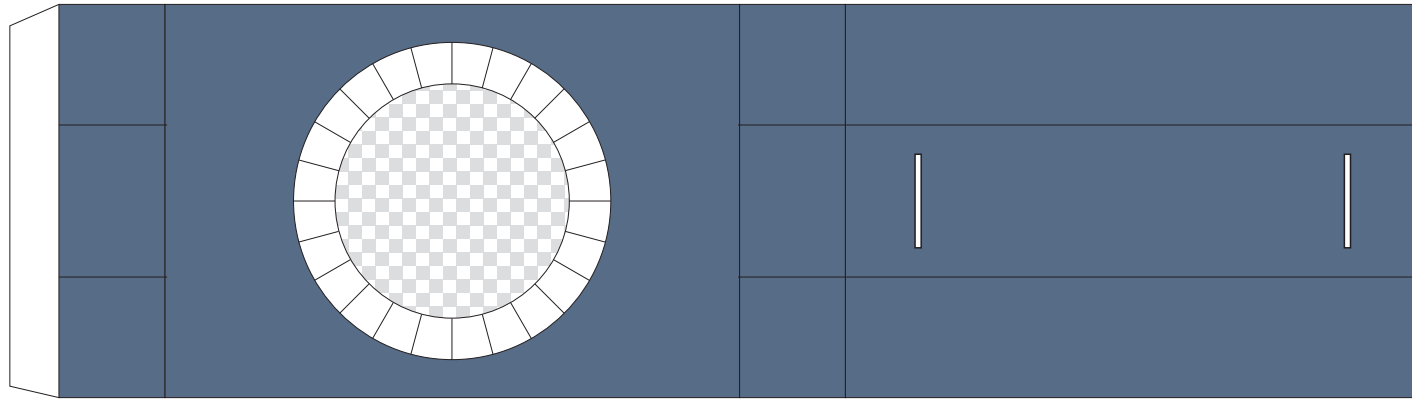

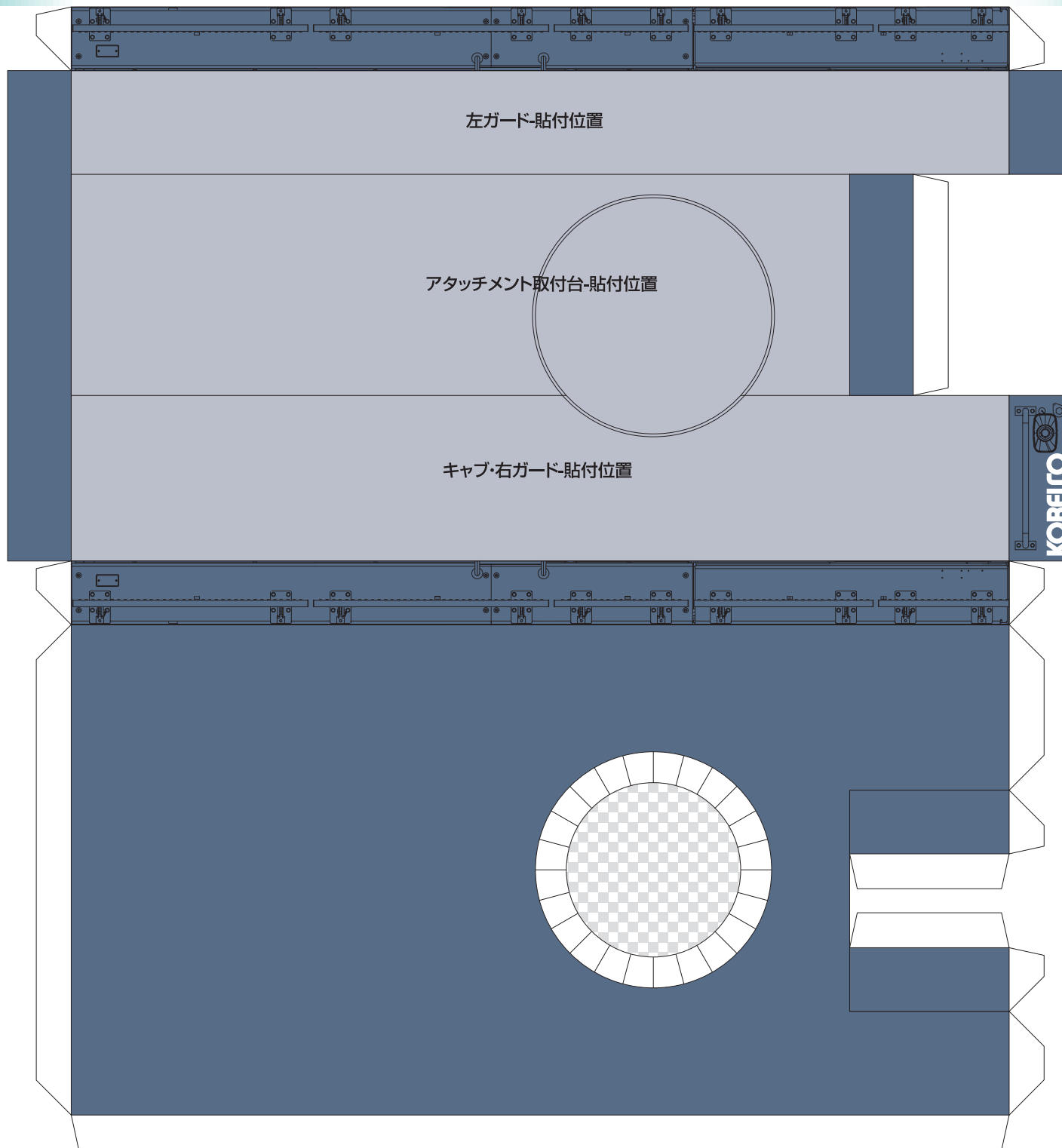

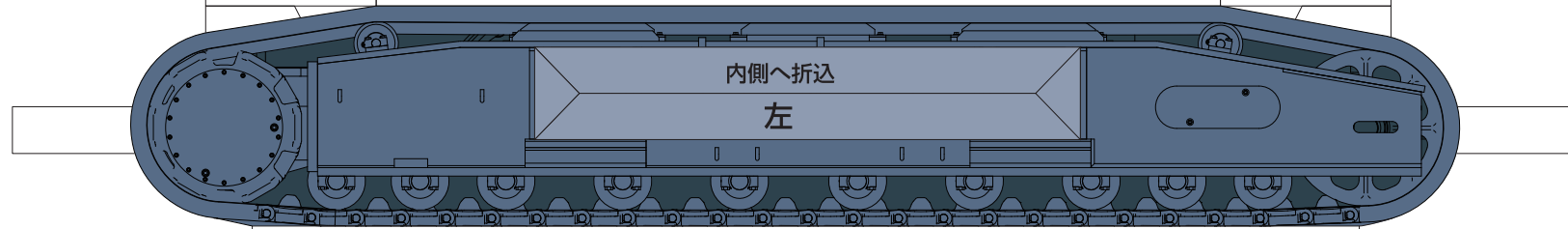
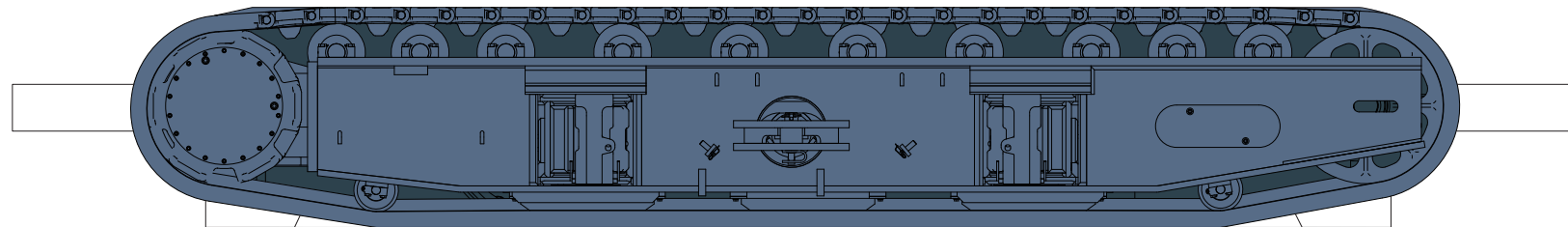
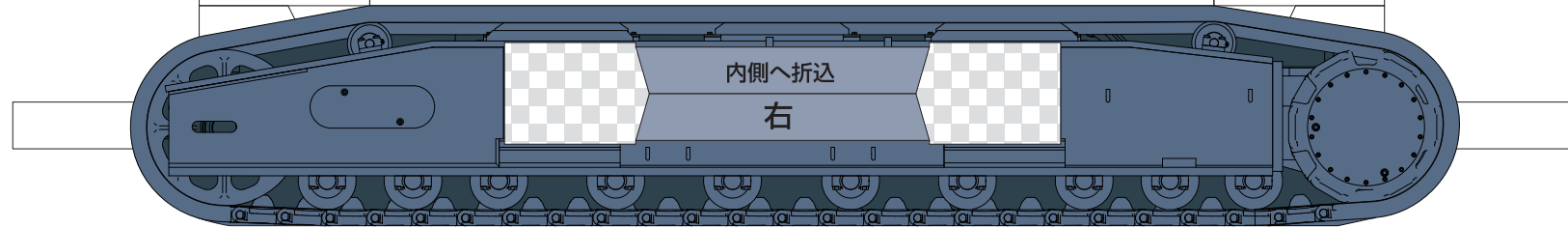
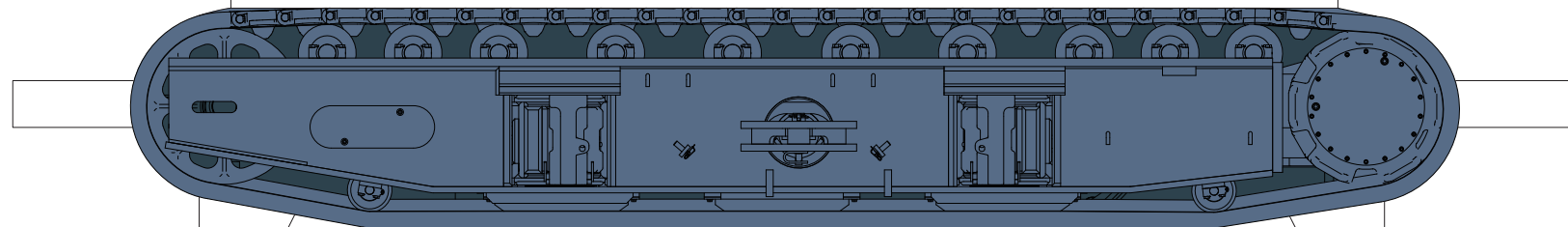

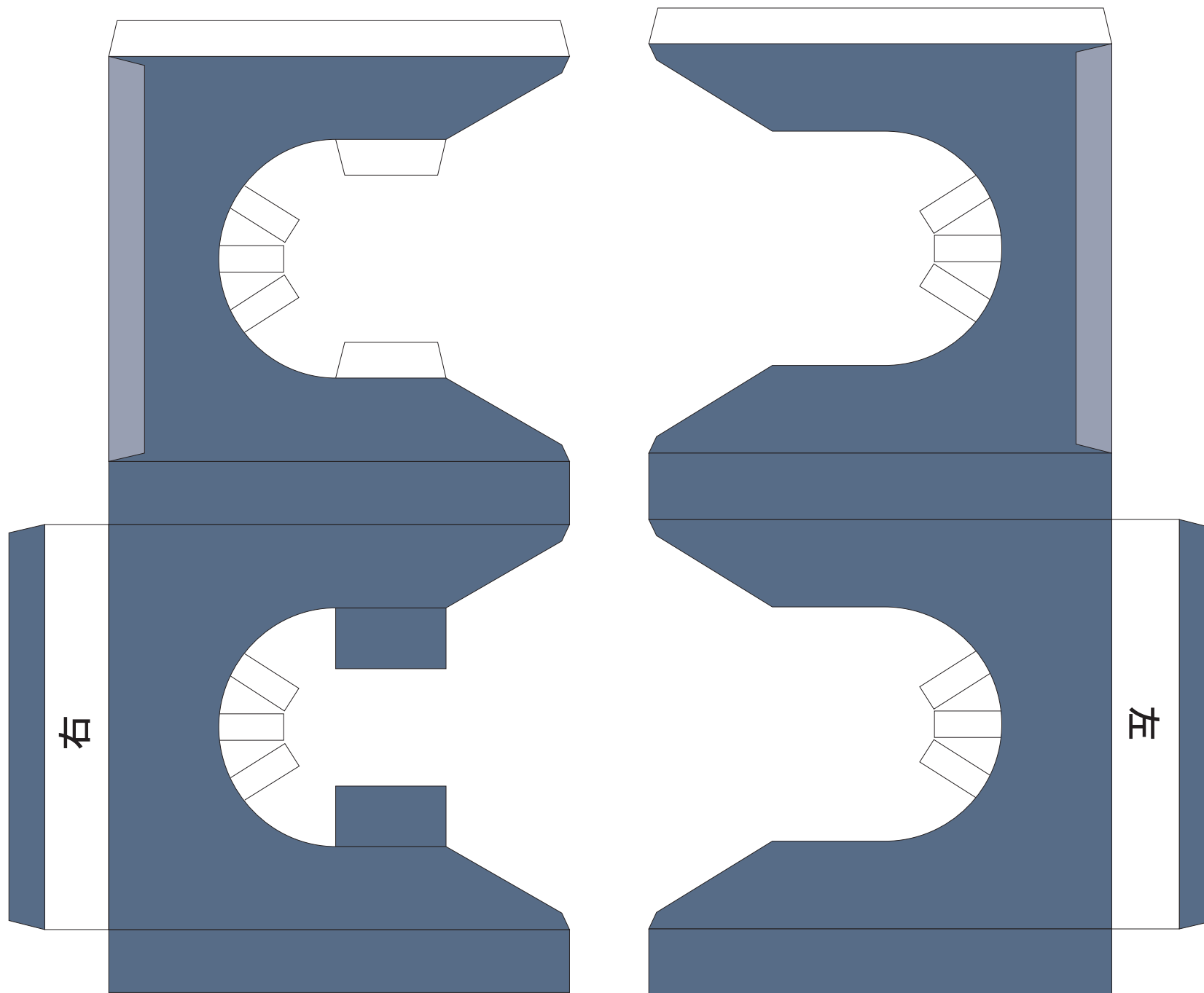

ブーム起伏用上部スプレッド

下部スプレッド

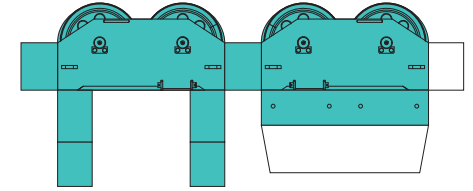
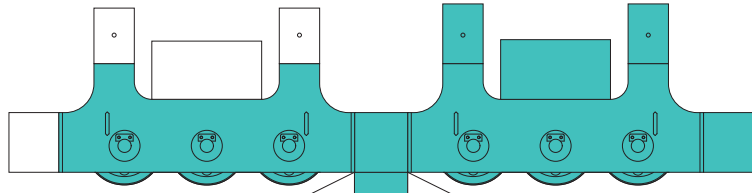

ガントリー

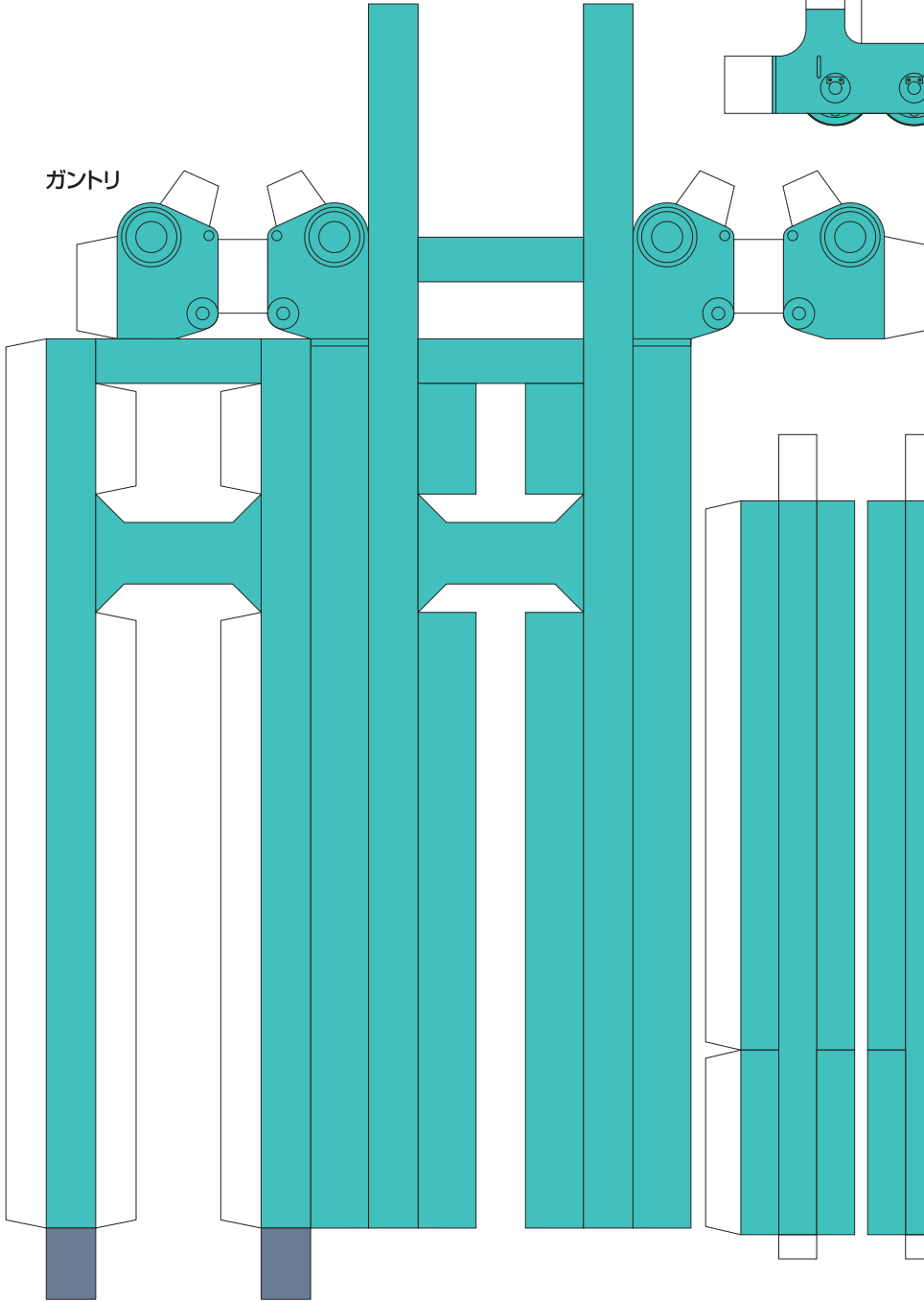

ブームバックストップ

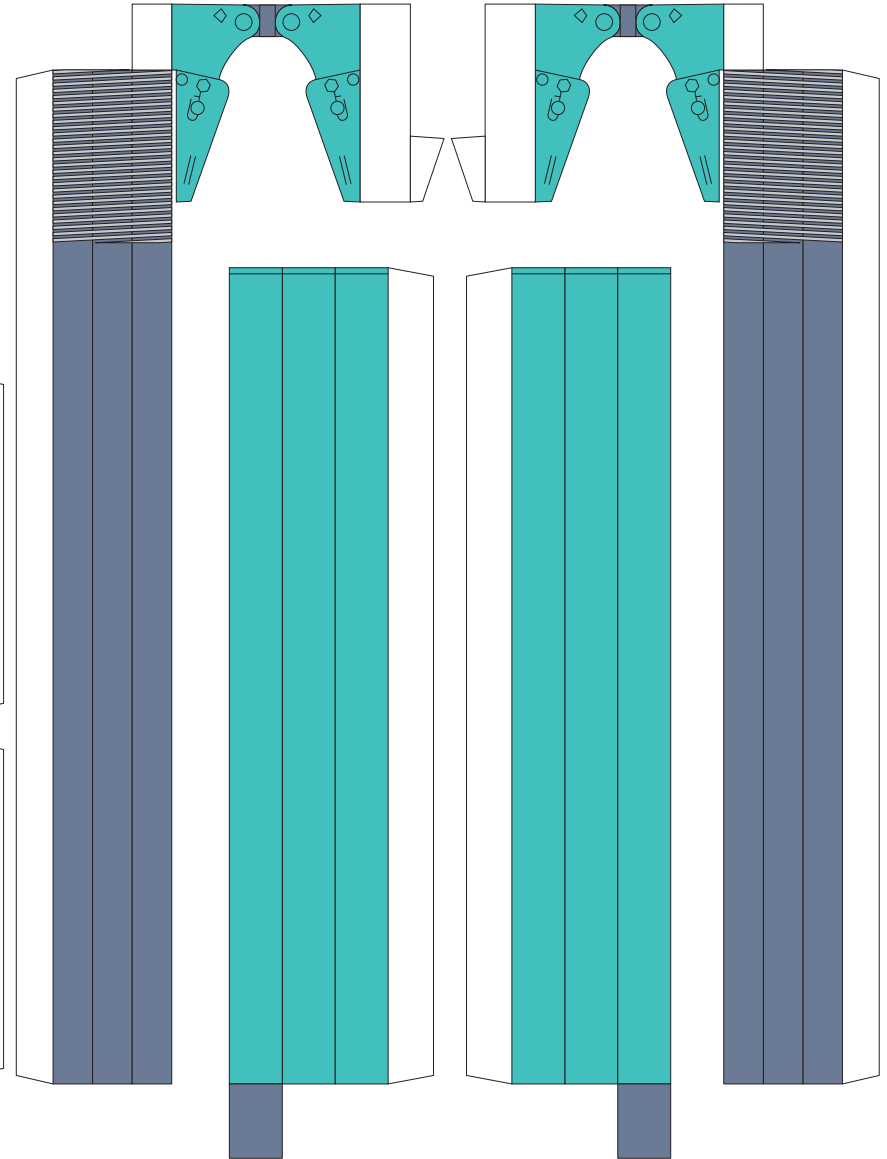

テンションメンバ

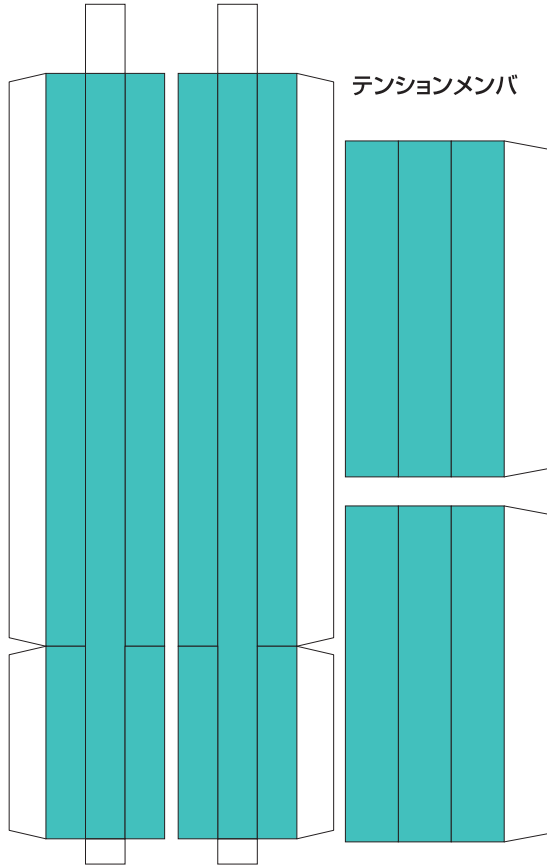

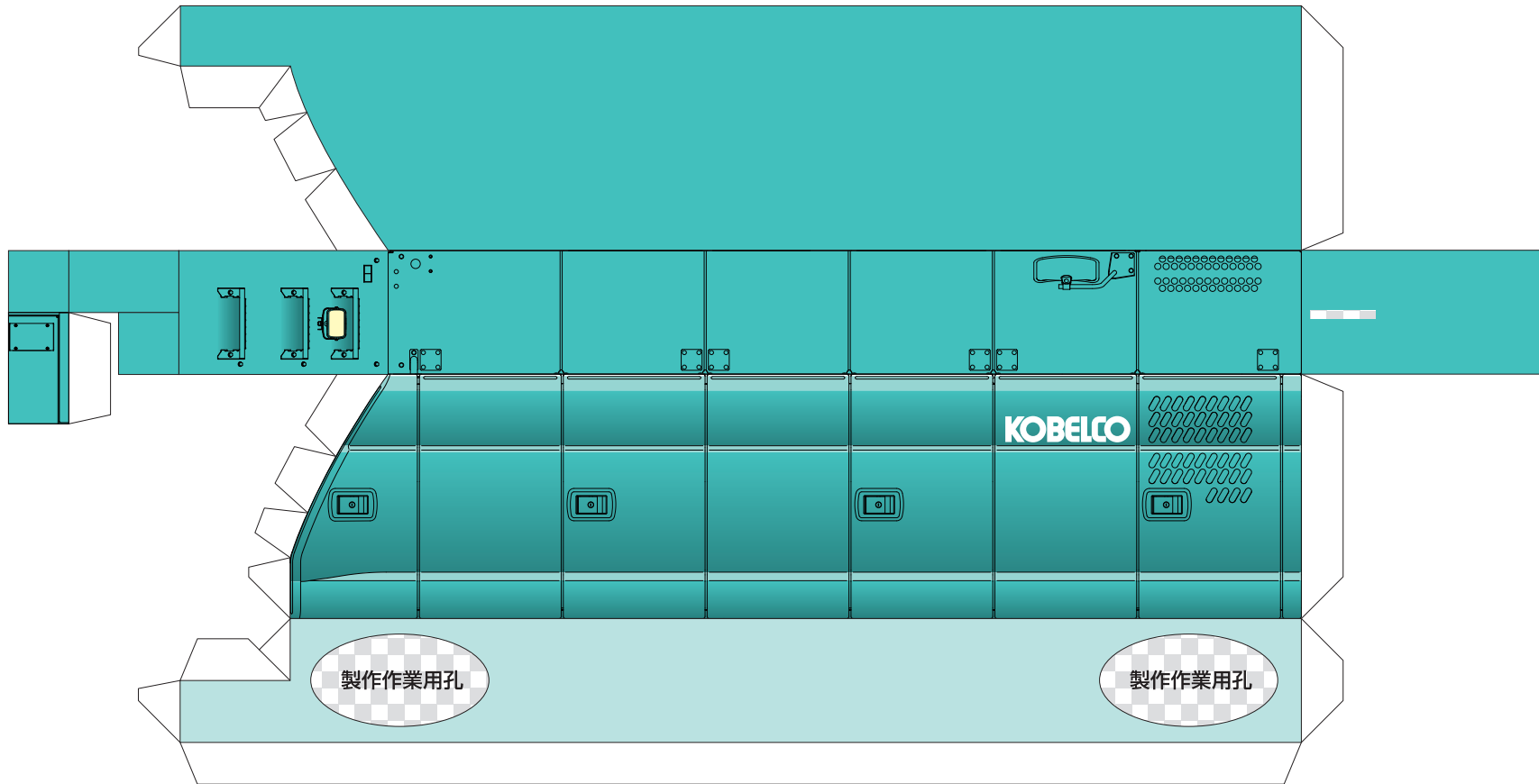

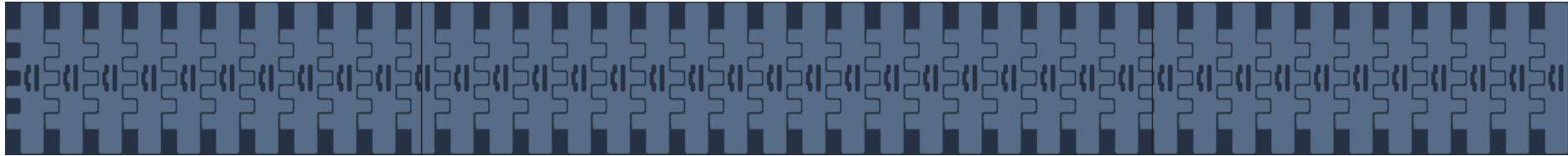

上側-前方向→

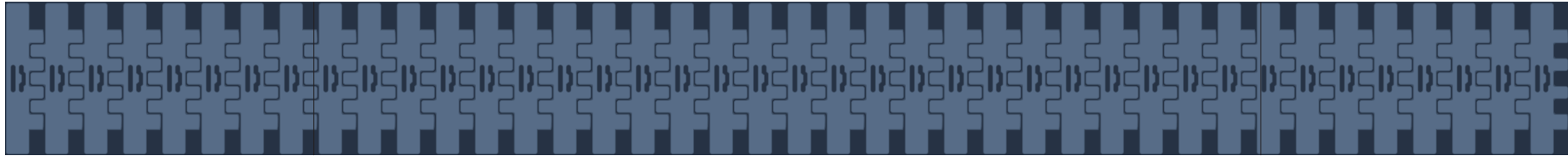

下側-前方向→

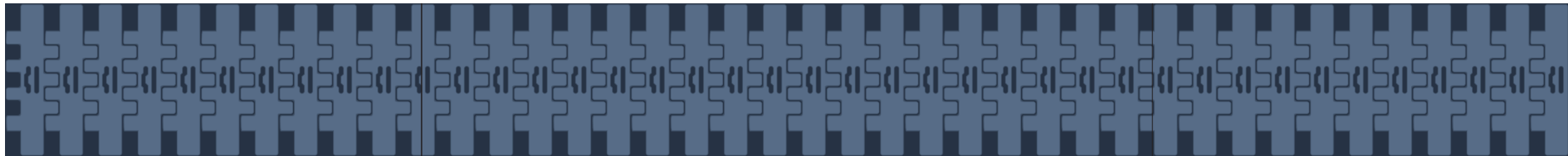

上側-前方向→

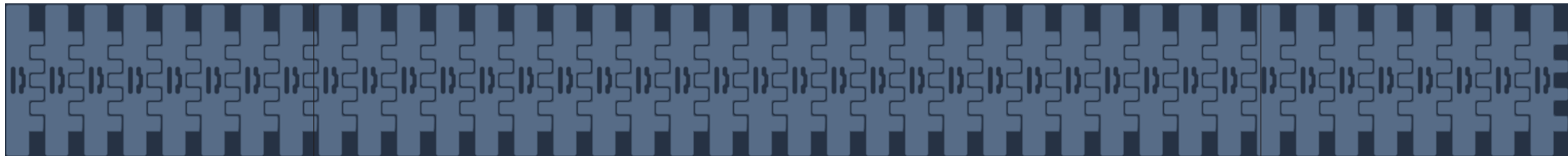

下側-前方向→



上部側-回転軸

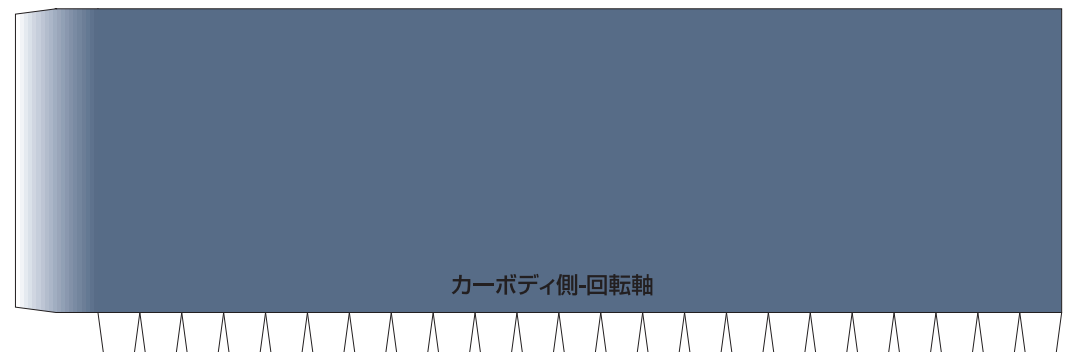

カーボディ側-回転軸

カウンタウエイト

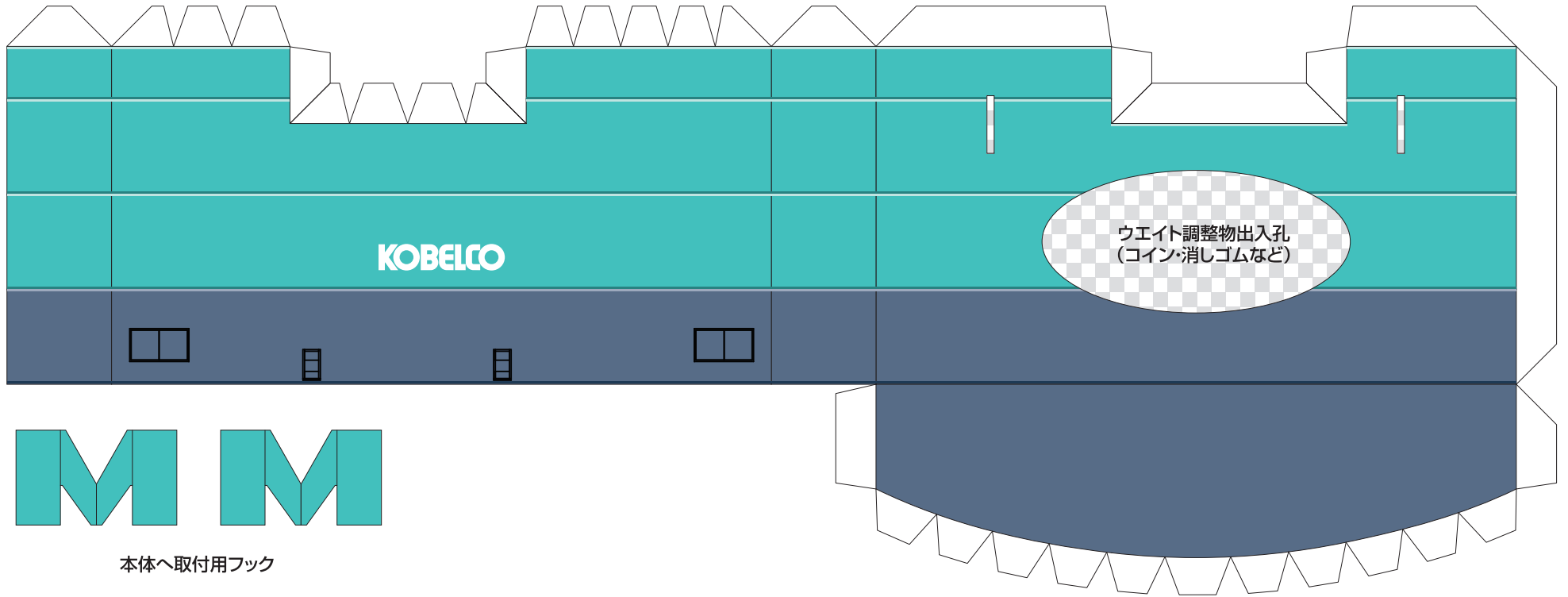
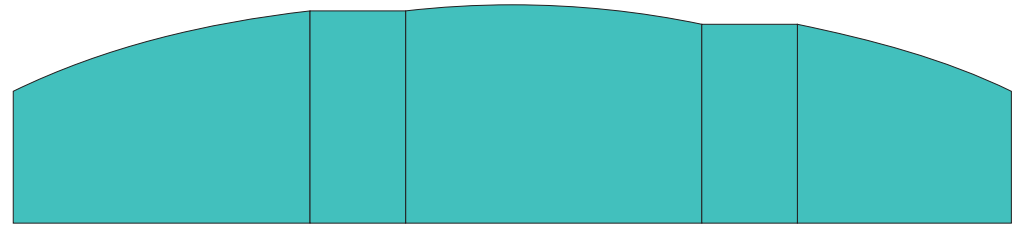

ウエイト調整物出入孔
(コイン・消しゴムなど)

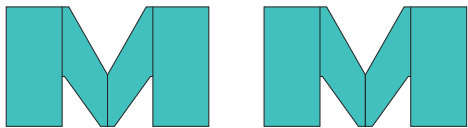

本体へ取付用フック