

Attachment mounting base

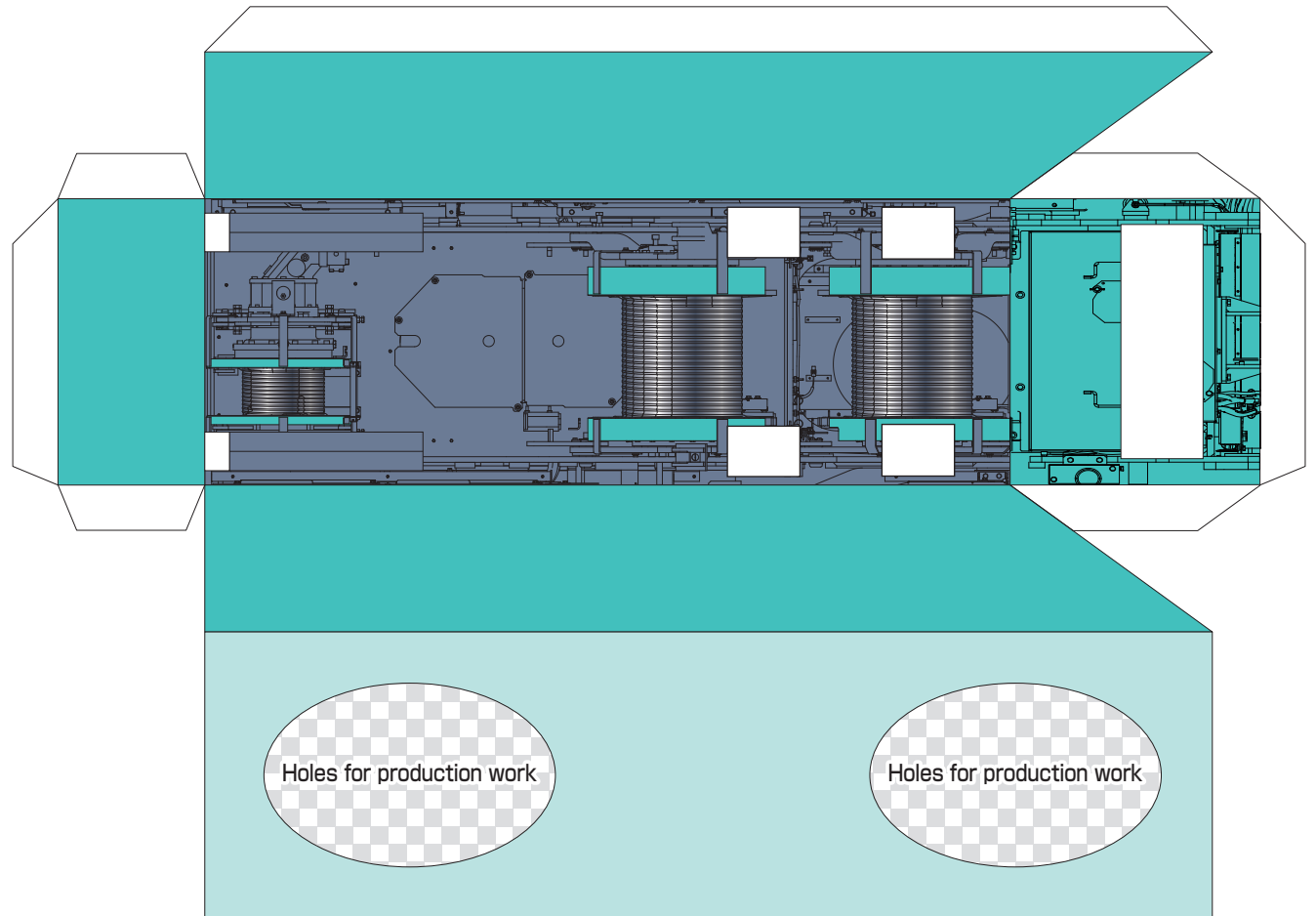

Boom base

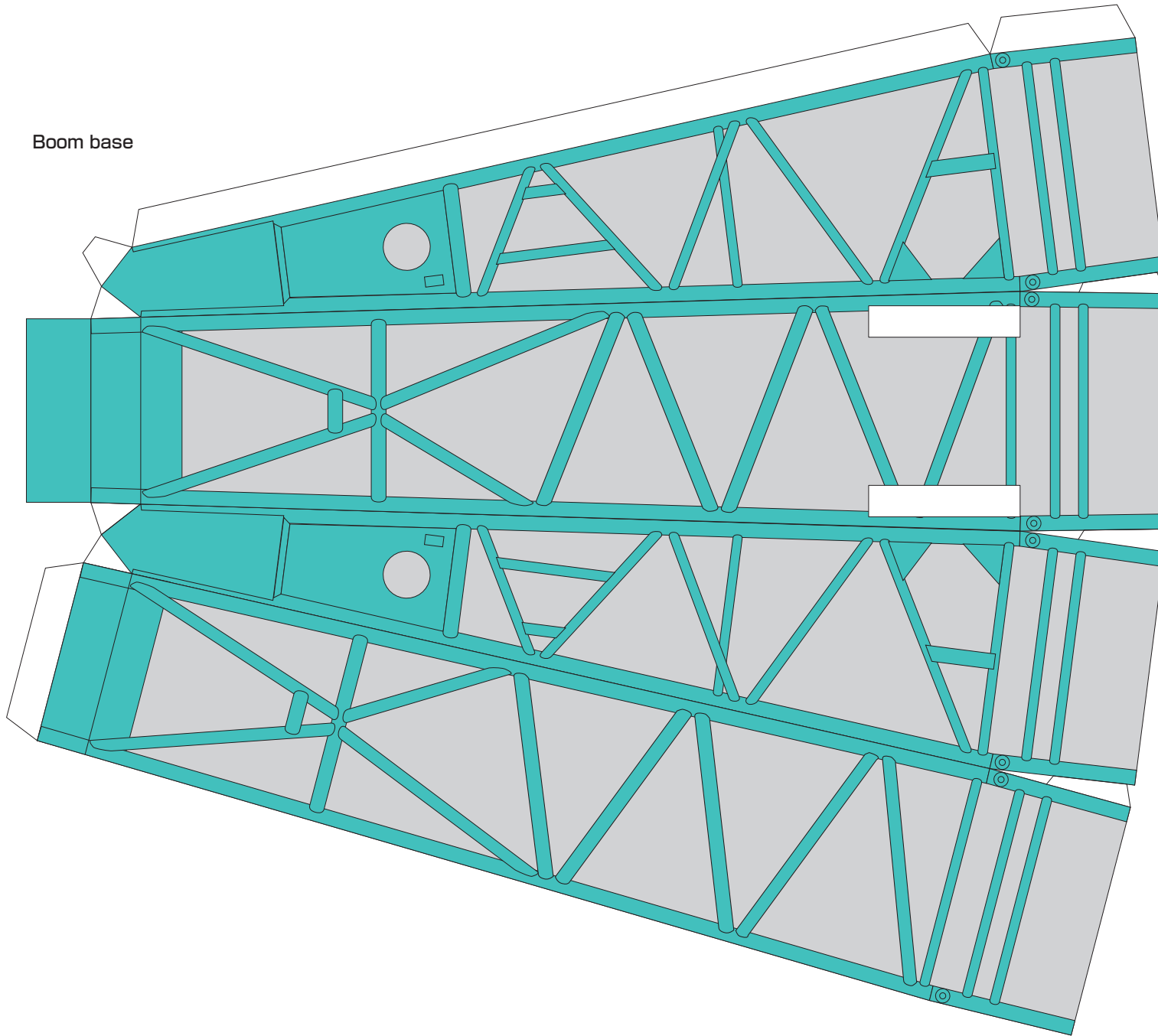

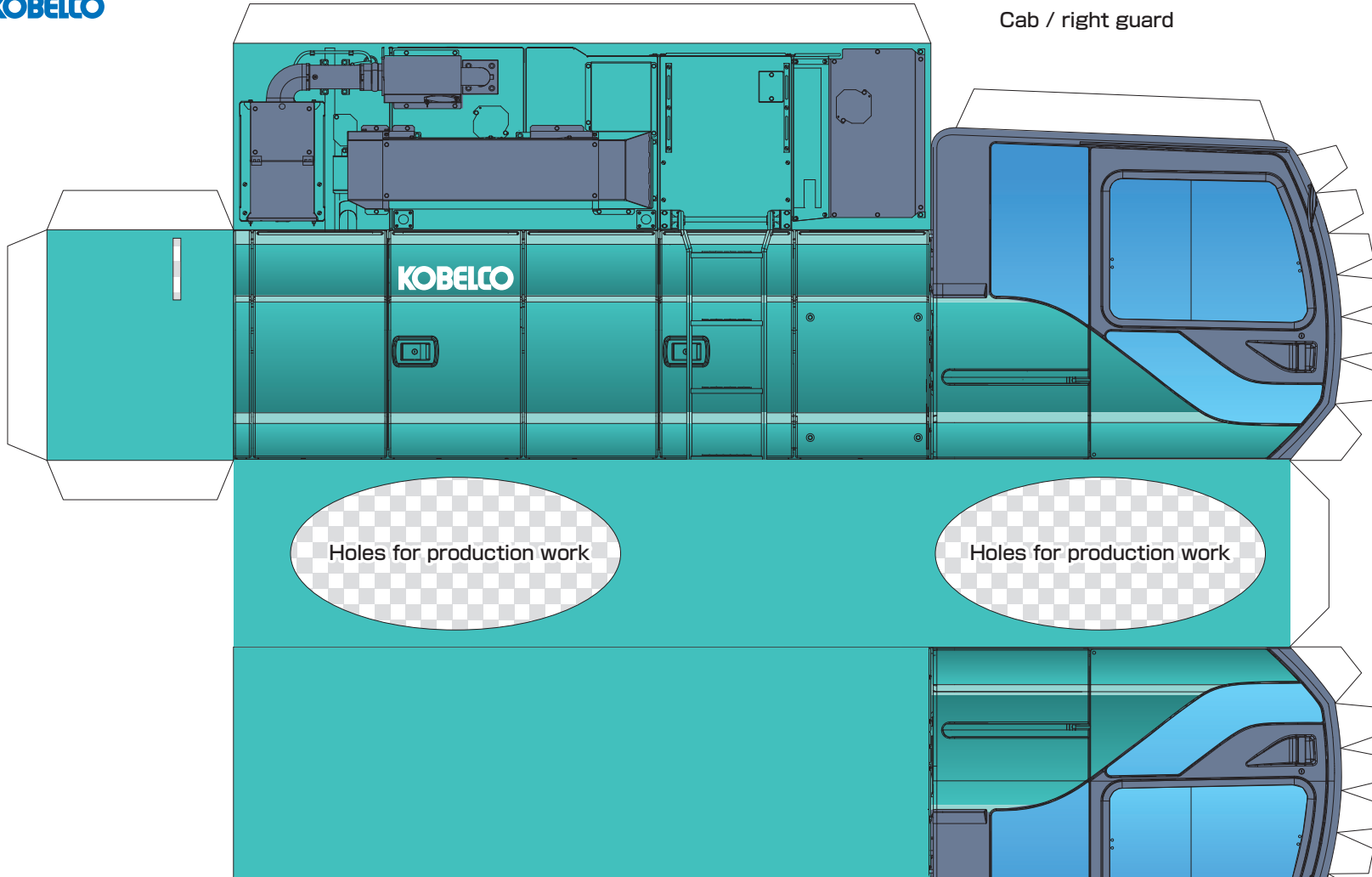

Cab / right guard

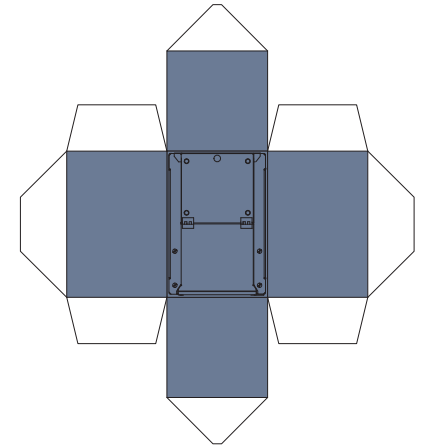

Muffler, etc.

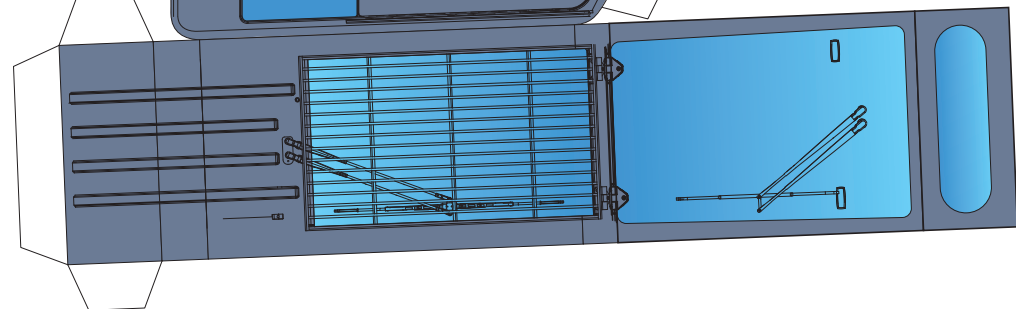
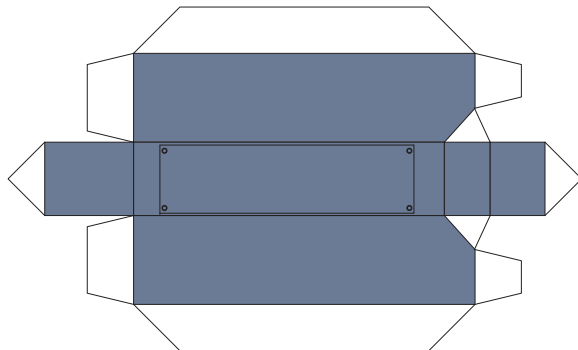
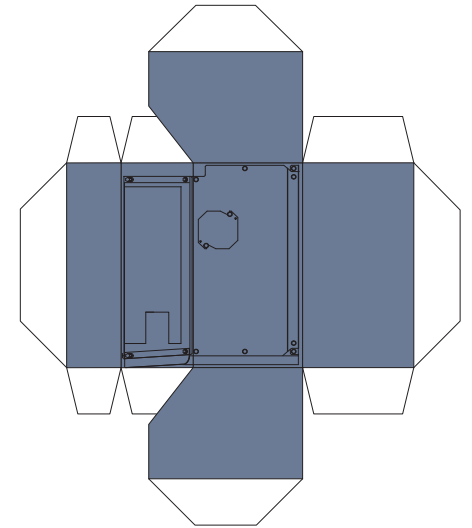

Car body / car body weight

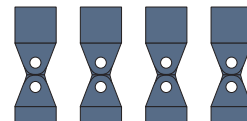
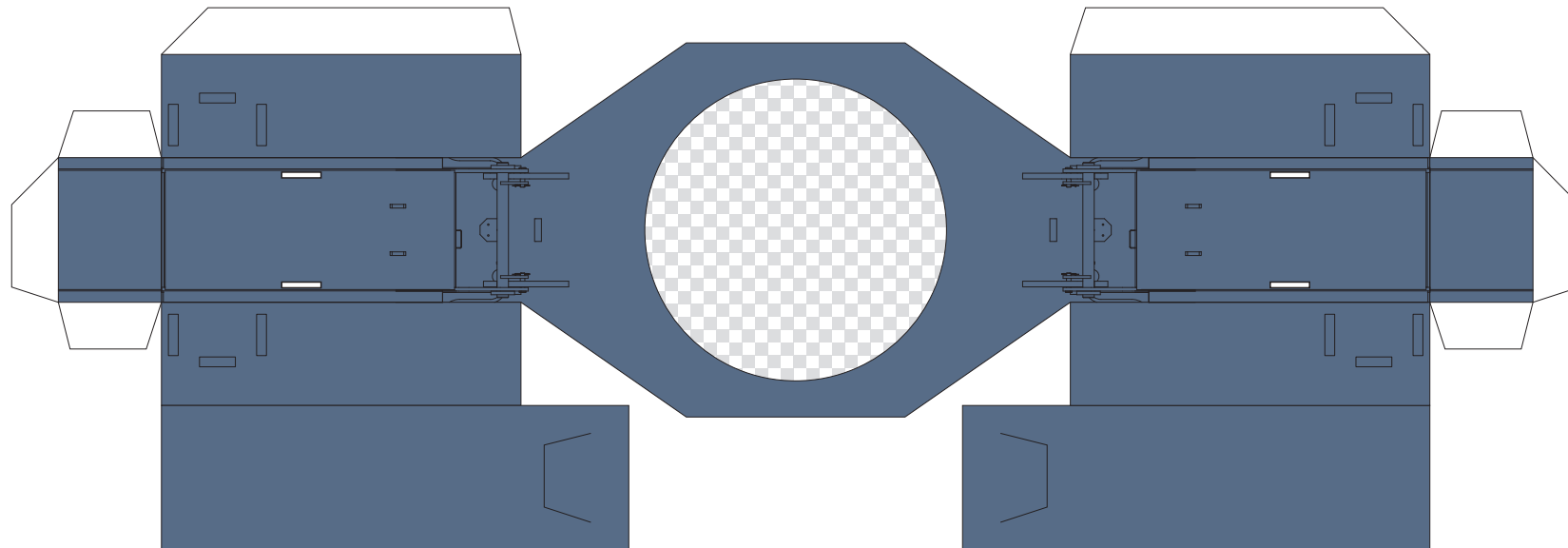
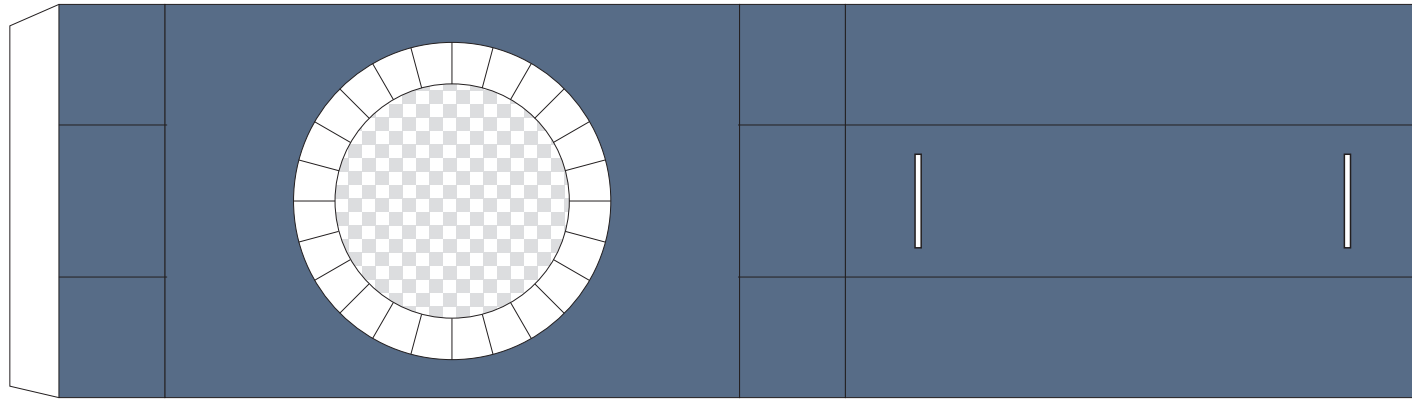

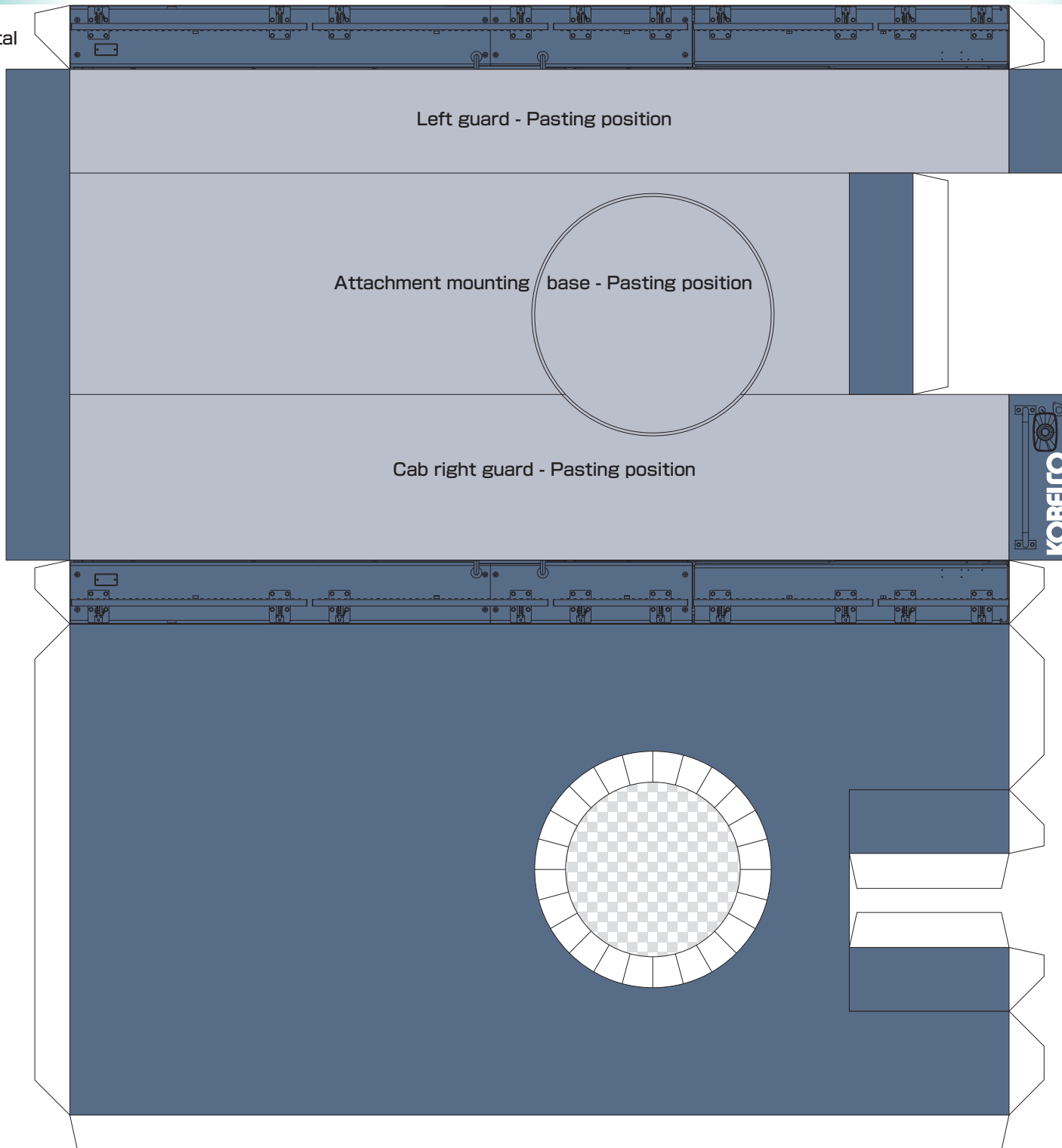

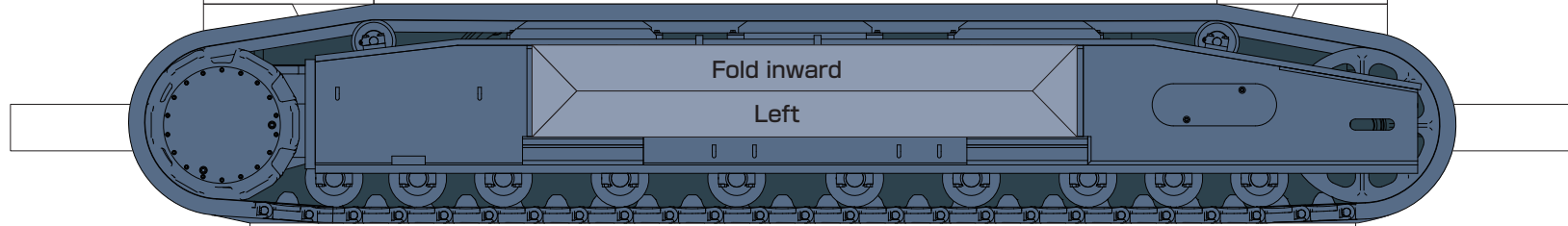
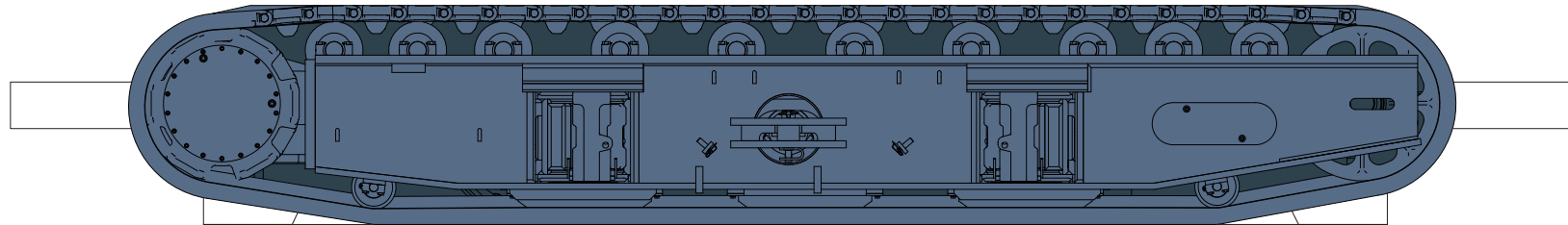
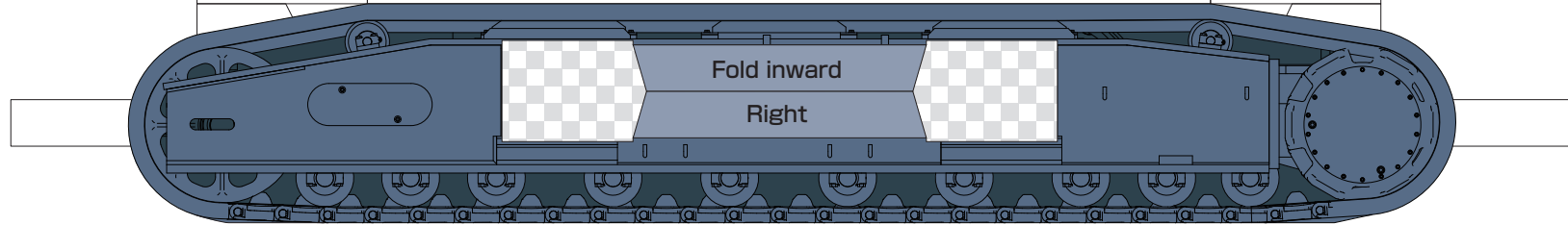
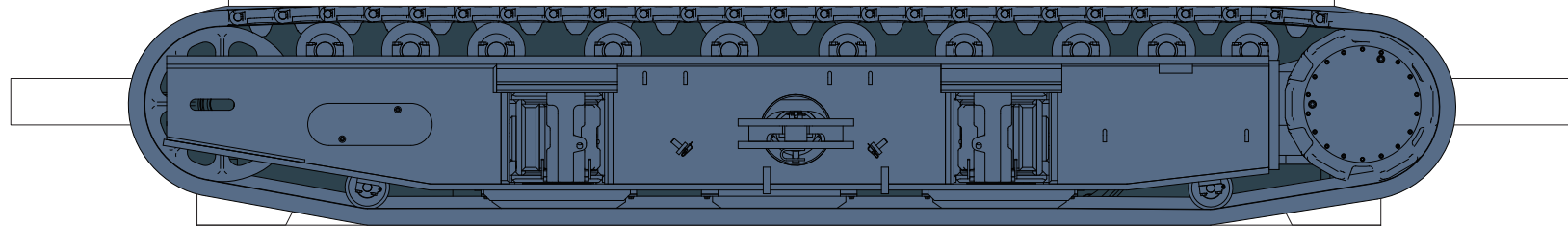

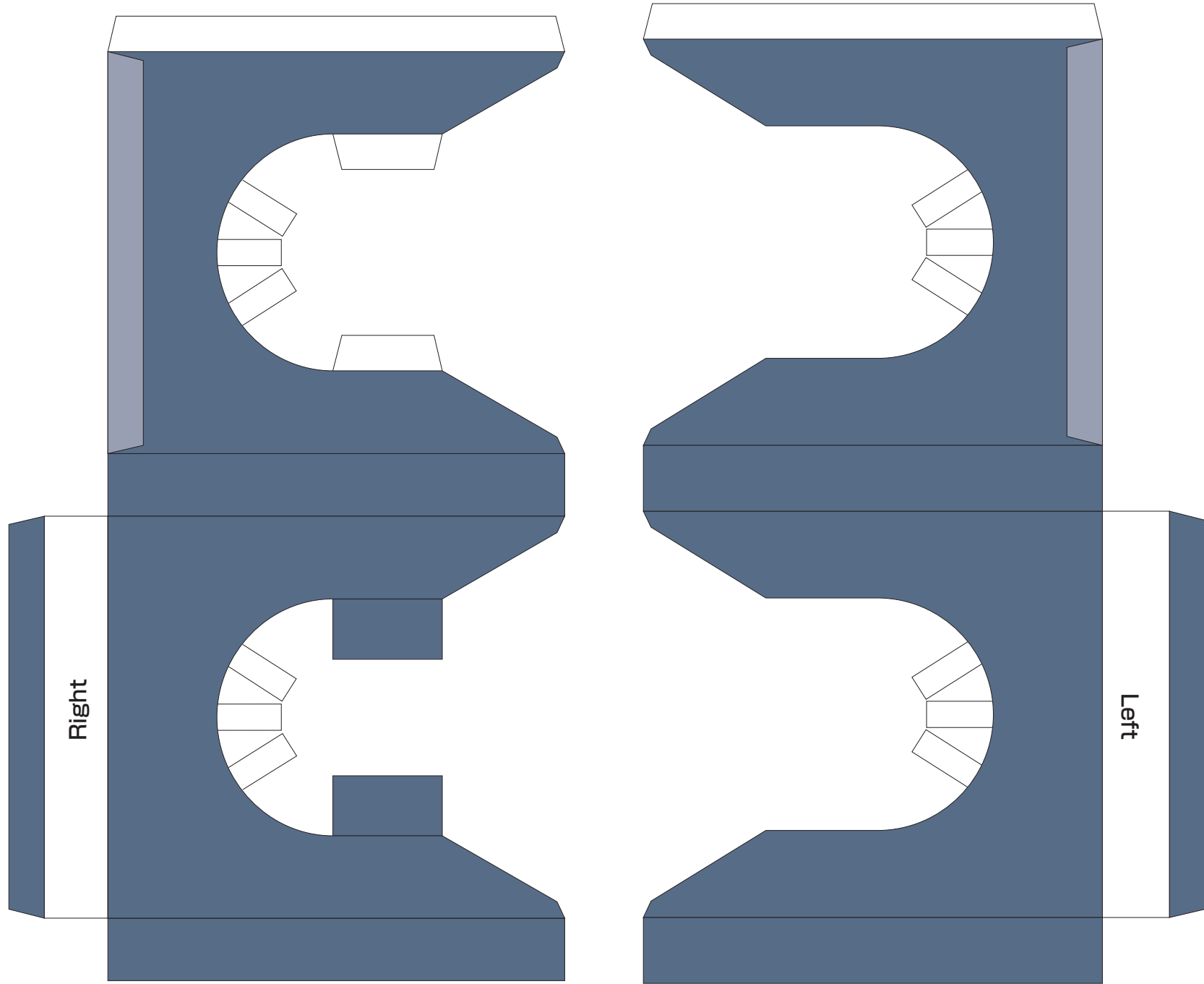



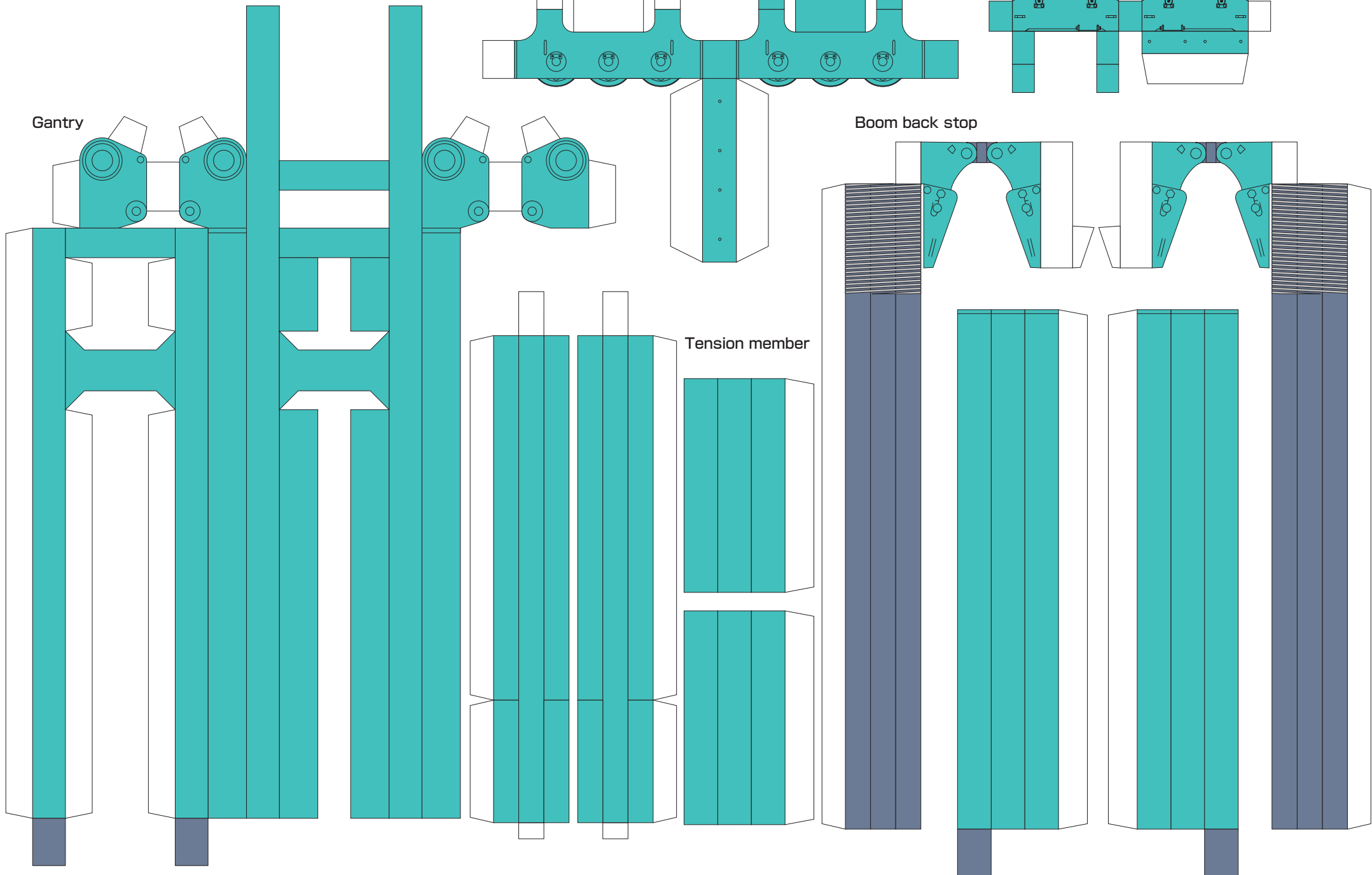

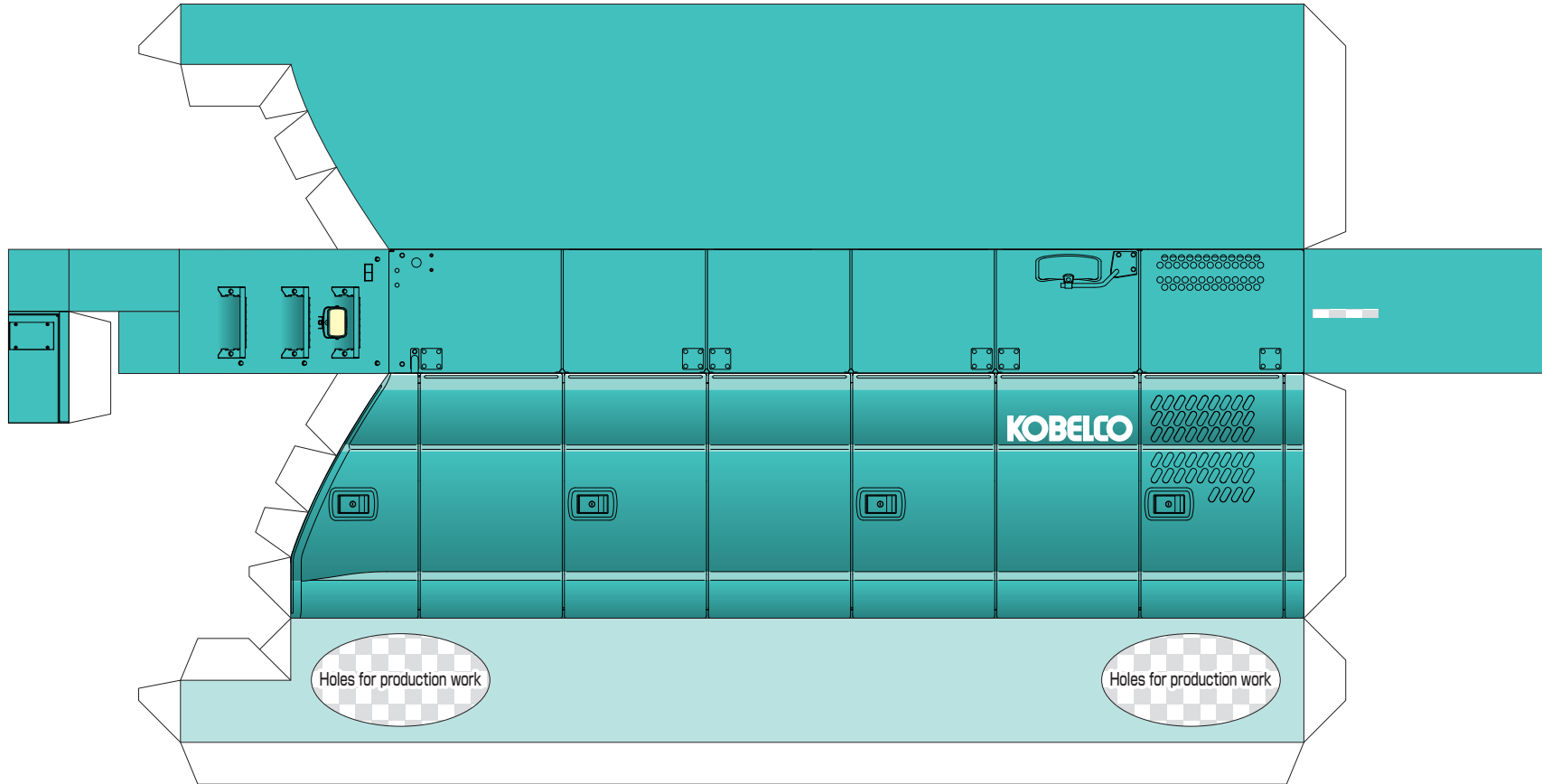

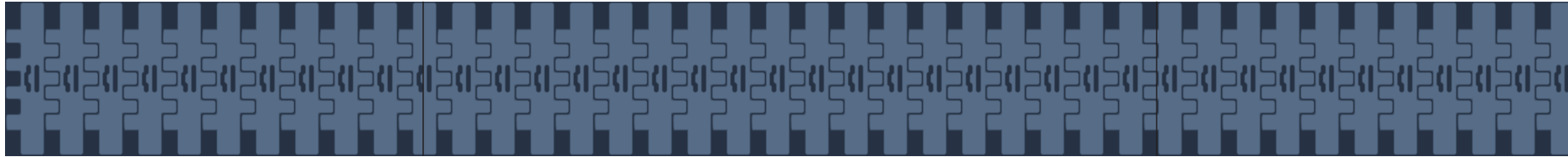

Upper side - forward direction →

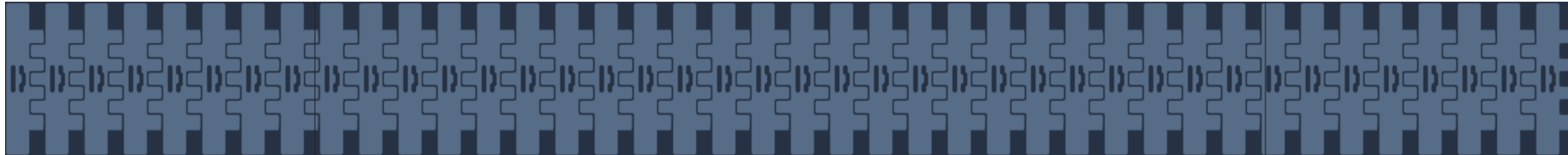

Lower side - forward direction →

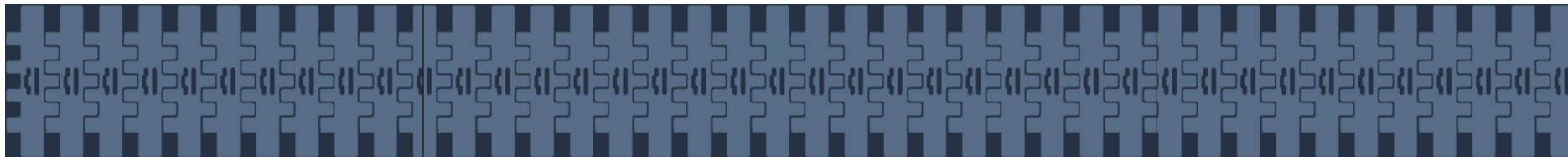

Upper side - forward direction →

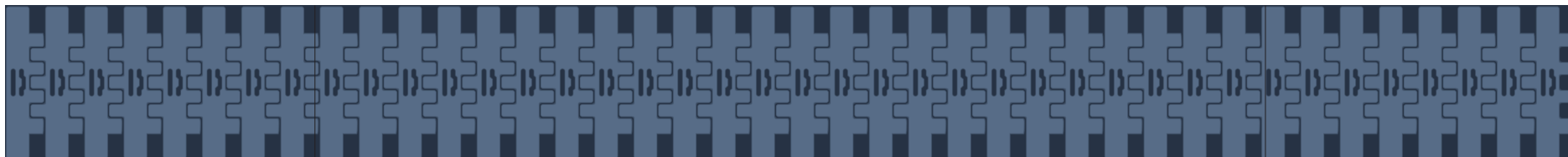

Lower side - forward direction →

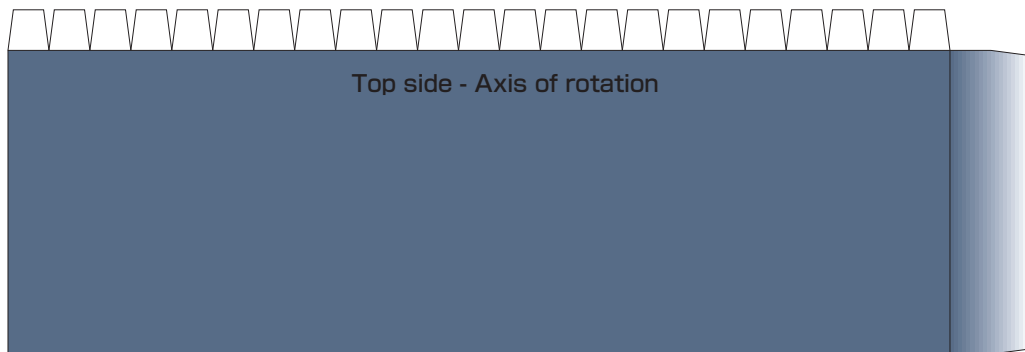

Top side - Axis of rotation

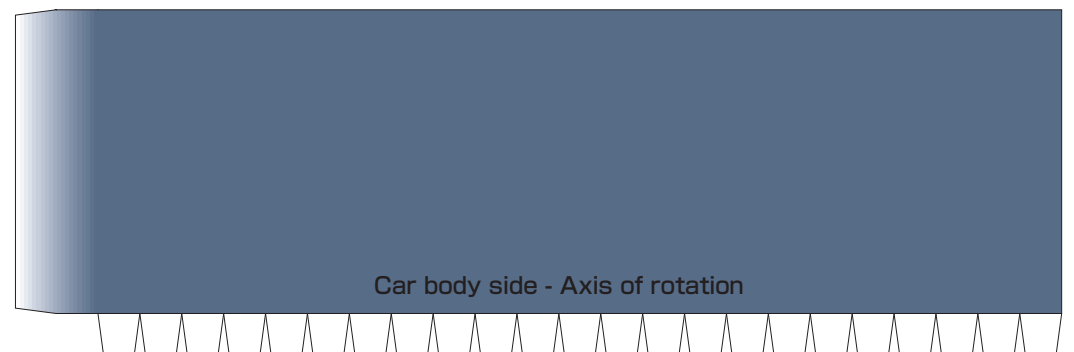

Car body side - Axis of rotation

Counterweight

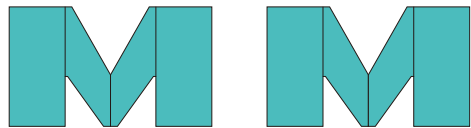
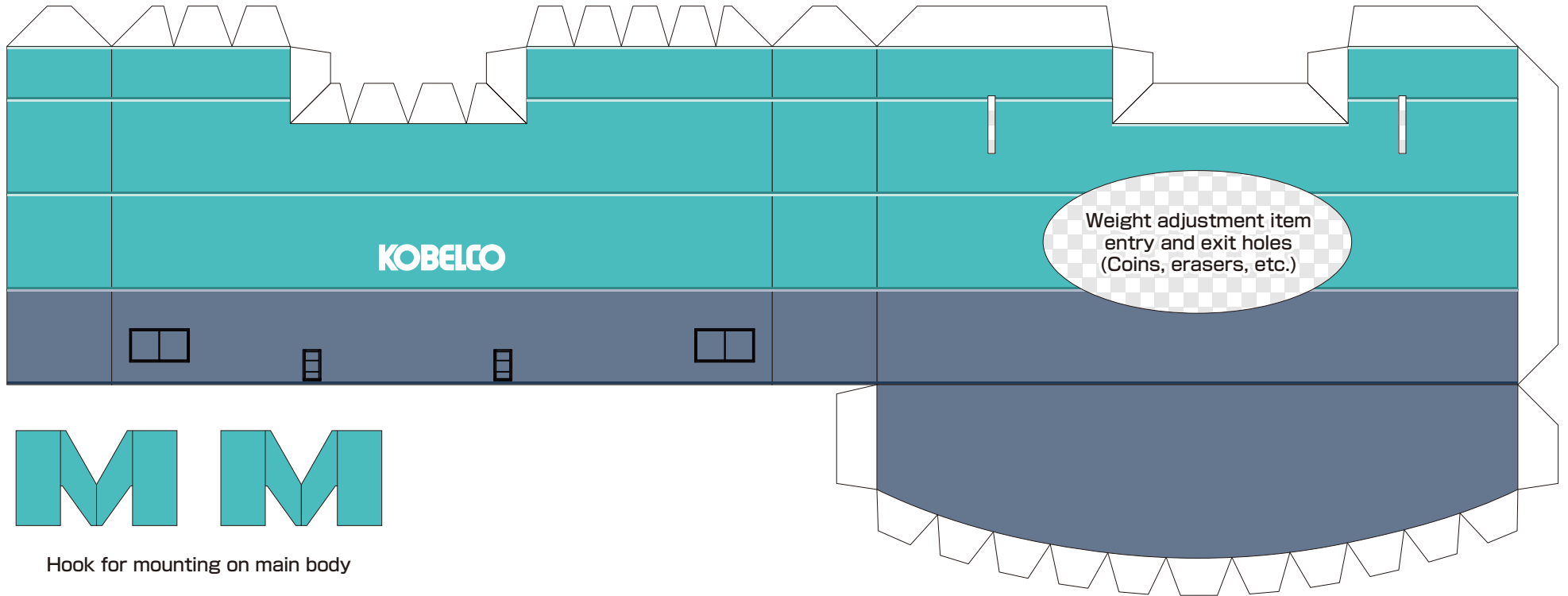
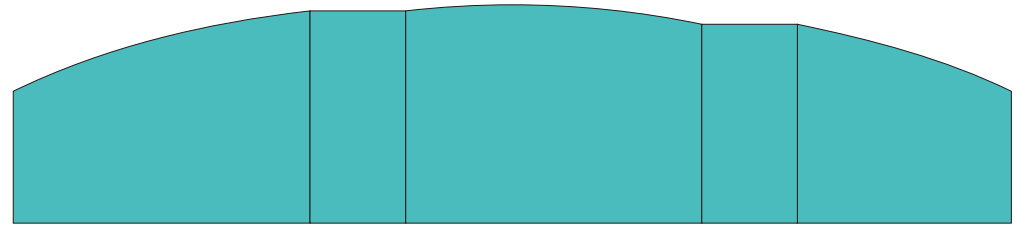

Hook for mounting on main body